

User manual

INTERACTIVE PANEL BLACK PRO

65"/ 75"/ 86"/ 98"



2026

| | |
|--|------------------|
| <u>1. PRODUCT DESCRIPTION.....</u> | <u>3</u> |
| <u>2. TECHNICAL SPECIFICATIONS</u> | <u>3</u> |
| <u>3. SAFETY WARNING</u> | <u>5</u> |
| <u>4. PREPARING FOR INSTALLATION</u> | <u>6</u> |
| <u>5. REMOTE CONTROL</u> | <u>8</u> |
| <u>6. IFP INTERFACE INPUTS & OUTPUTS.....</u> | <u>9</u> |
| <u>7. FIRST STARTUP.....</u> | <u>10</u> |
| <u>8. SETTING A SCREEN LOCK.....</u> | <u>19</u> |
| <u>9. NFC.....</u> | <u>20</u> |
| <u>10. SETTING UP THE AI STYLUS</u> | <u>22</u> |
| <u>11. CONNECTION AND SET-UP</u> | <u>23</u> |
| <u>12. ANDROID SYSTEM</u> | <u>25</u> |
| <u>13. BASIC OPERATIONS</u> | <u>26</u> |
| <u>14. WI-FI MODULE</u> | <u>27</u> |
| <u>15. NETWORK SETTINGS</u> | <u>28</u> |
| <u>16. OTA UPDATE</u> | <u>30</u> |
| <u>17. TROUBLESHOOTING</u> | <u>32</u> |
| <u>18. MAINTENANCE.....</u> | <u>33</u> |
| <u>19. REPAIR SERVICE AND CONTACTS.....</u> | <u>34</u> |

1. Product Description

INTERACTIVE PANEL TRIUMPH BOARD

INTERACTIVE PANEL TRIUMPH BOARD is a fully integrated professional UHD panel with great performance and top-notch imaging features.

INTERACTIVE PANEL TRIUMPH BOARD is an effective presentation tool, which displays a lesson or presentation in any classroom or meeting room. The latest infrared optical technology allows for 50-finger touch, meaning up to 25 people can write or draw on the panel at the same time with a finger or stylus.

2. Technical Specifications

TRIUMPH BOARD 65" IFP BLACK PRO

| | |
|---------------------|----------------------|
| EAN: | 8592580122361 |
| Panel Type: | VA DLED Backlight |
| Resolution: | 3840 × 2160 |
| Brightness: | 450 cd/m2 (500 max.) |
| Contrast: | 5000:1 |
| Response Time: | ≤ 6,5 ms |
| Refresh rate: | 60 Hz |
| Display area: | 1429 (H) x 804 (W) |
| Product dimensions: | 1488 x 908 x 86 mm |
| Box dimensions: | 1628 x 1014 x 185 mm |
| Net / Gross weight: | 36 / 42 kg |

TRIUMPH BOARD 75" IFP BLACK PRO

| | |
|---------------------|-----------------------|
| EAN: | 8592580122354 |
| Panel Type: | VA DLED Backlight |
| Resolution: | 3840 × 2160 |
| Brightness: | 450 cd/m2 (500 max.) |
| Contrast: | 5500:1 |
| Response time: | ≤ 6,5 ms |
| Refresh rate: | 60 Hz |
| Display area: | 1651 (H) x 929 (W) mm |
| Product dimensions: | 1709 x 1031 x 86 mm |
| Box dimensions: | 1863 x 1155 x 225 mm |
| Net / Gross weight: | 47 / 57 kg |

TRIUMPH BOARD 86" IFP BLACK PRO

| | |
|---------------------|------------------------|
| EAN: | 8592580122347 |
| Panel Type: | IPS DLED Backlight |
| Resolution: | 3840 × 2160 |
| Brightness: | 450 cd/m2 (500 max.) |
| Contrast: | 1200:1 |
| Response Time: | ≤ 8 ms |
| Refresh rate: | 60 Hz |
| Display area: | 1895 (H) x 1066 (W) mm |
| Product dimensions: | 1957 x 1171 x 97 mm |
| Box dimensions: | 2110 x 1304 x 225 mm |
| Net / Gross weight: | 55 / 70 kg |

TRIUMPH BOARD 98" IFP BLACK PRO

| | |
|---------------------|-------------------------------|
| EAN: | 8592580122378 / 8592580121616 |
| Panel Type: | ADS DLED Backlight |
| Resolution: | 3840 × 2160 |
| Brightness: | 450 cd/m2 (500 max.) |
| Contrast: | 1200:1 |
| Response Time: | ≤ 8 ms |
| Refresh rate: | 60 Hz |
| Display area: | 2159 (H) x 1215 (W) mm |
| Product dimensions: | 2220 x 1319 x 89 mm |
| Box dimensions: | 2406 x 1485 x 280 mm |
| Net / Gross weight | 85 / 109 kg |

Touch system

| | |
|---------------------------|---|
| Number of touch points: | 50 (Windows/ Android) |
| Touch technology: | Infrared transmission (multitouch) |
| Response time: | ≤ 2.5 ms (65"/ 75"), ≤ 5 ms (86"/ 98") |
| Interpolation resolution: | 32768 × 32768 |
| Communication bus: | USB 2.0 |
| Glass Type: | Anti-Glare, tempered, safety glass (hardness 7 Mohs) |

Inputs & Outputs

| | |
|------------|--------------|
| HDMI IN: | 3 (1x front) |
| HDMI OUT: | 1 |
| USB Type-C | 2 (1x front) |
| VGA: | 1 |
| AUDIO IN: | 1 |
| AUDIO OUT: | 1 |
| LAN: | 2 |
| SPDIF: | 1 |
| USB 2.0: | 1 |
| USB 3.0: | 4 (2x front) |
| TOUCH USB: | 2 (1x front) |
| RS 232: | 1 |

Sound system

| | |
|------------------|-----------------------|
| Power amplifier: | 2 x 25 W (2.0) + 20 W |
|------------------|-----------------------|

Power

| | |
|--------------------------------|---------------------------------|
| Power Requirements: | 100 – 240 V AC 50/60 Hz |
| Power Consumption without OPS: | 132 W / 154 W / < 179 W / 213 W |
| Standby Power Consumption: | ≤ 0.5 W |

Ambient conditions

| | |
|------------------------|---------------|
| Operation Temperature: | 0°C ~ 40°C |
| Operation Humidity: | 10% ~ 90% RH |
| Storage Temperature: | - 20°C ~ 60°C |
| Storage Humidity: | 10% ~ 90% RH |

Android system models 65"/ 75"/ 86"/ 98"

| | |
|----------|--------------------------|
| Version: | Android 16.0 |
| CPU: | ARM Cortex-A72x4 + A53x4 |
| GPU: | Mali G52MC3 |
| RAM: | 8/ 16 (98") GB |
| ROM: | 128/ 256 (98") GB |

3. Safety Warning

Before using the device, read the instructions carefully.

Placement

- Do not place the device on unstable surfaces, easy to tilt, or surfaces that can fall.
- Do not place the device in places with direct sunlight or near heat sources, such as electric heaters or bright light sources.
- Do not use the device next to appliances that generate magnetic fields.
- Do not place the device in damp places or where it might be exposed to moisture or liquids. • Do not insert any items inside the device.
- Do not place heavy objects on the device.
-

Power supply

- Verify compatibility between the voltage rating on the back shell nameplate and the main power supply voltage rating.
- In case of thunderstorms and lightning weather, unplug the power cord and antenna plug.
- When no one is indoors, or the device will not be used for an extended time, unplug the power cord.
- Protect the power cord from physical or mechanical damage.
- Use the original power cord, and do not modify or extend the power cord.
- Check and make sure the AC power ground wire is connected.

Screen

- When writing on the screen, do not use hard or sharp objects.
- When the screen requires cleaning, unplug the power cord first.
- Use a soft, dust-free, dry cloth to wipe the screen.
- Do not use water or a spray cleaner to clean the device.
- Contact the service centre for internal cleaning of the device.
- Do not display an image with high brightness on the screen for a long time.
- Turn off the device after usage; it is not made for 24/7 use. Recommended screen time is 16/7.

Range of visibility

- The ideal distance between the eyes of the viewer and the screen is 2 to 7 times the screen diagonal.
- The best viewing angle between the eyes of the viewer and the screen is within 178 degrees up and down, left and right.

Temperature

- Do not place the device near an electric radiator or heating unit.
- When moving the device from a low-temperature area to a high-temperature area, before connecting the device to power, leave the device idle in the new environment for some time to allow for temperature adjustment and to sufficiently diffuse internal condensation before powering on.
- The device's normal working temperature is 0~40°C, storage temperature is -20~60°C.

Humidity

- Do not expose the device to rain, moisture, or places near water
- Make sure the indoor environment is cool and dry, the device's normal operating humidity is 10 - 90% RH, and storage humidity is 10~90%

Ventilation

- Place the device in ventilated places and ensure the device's good heat dissipation.
- Ensure ventilation gaps of 10cm(4 inches) on the sides and back, 30cm(12 inches) on the top of the device.

Headphones

- Extended use of headphones at high volumes may damage hearing. If external headphones/ earbuds are needed, turn down the device volume in advance.

Power button

- If you hold the power button on the front of the device for 1 second, this will not completely shut off the device but only place the device in standby mode. For a complete shutdown, press and hold the power button for 3 seconds.
- If the control diode flashes, do not switch off the IFP with the power switch, or do not unplug the device from the socket. As a result, your equipment may not power on, and repair by a service technician may be required. The device can be turned off using the main switch and unplugged from the socket when the light is still red.

Battery

- Dispose of used batteries properly and recycle them
- To avoid danger, do not let children touch the battery, and avoid contact with water

Caution

- This device may cause radio interference in the living environment. In this case, the user may be required to take practical measures to mitigate the effects

Notes on cleaning

- There are vents on the back cover. Do not use any liquid on or spray this area directly during cleaning.
- It is recommended to use the recommended cleaning products (more on page 33)

Notes on Maintenance

- This device can only be serviced by a certified engineer

Power switch status indicators

- "I" means power on, "O" means power off.

4. Preparing for Installation

Unpacking

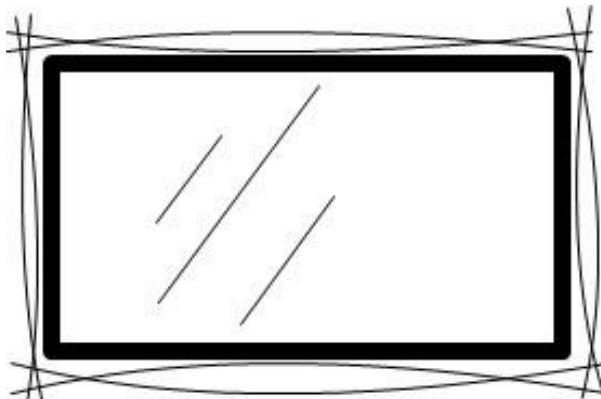

Accessories

Quick Start Guide, 2x stylus, remote control, AI stylus, Wi-Fi Module, power cable (UK, US, EU), touch USB cable, and HDMI cable.

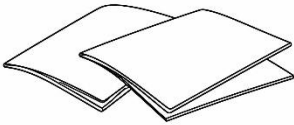

1x Quick Start Guide

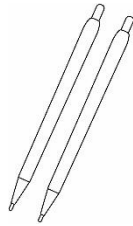

2x stylus



1x Remote Control



1x AI Stylus

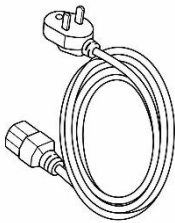

1x Power Cable (US, UK, EU)

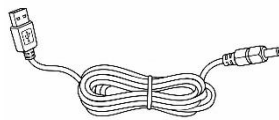

1x USB Touch Cable

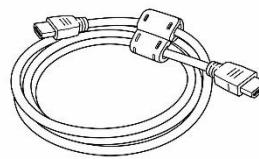

1x HDMI Cable



1x Wi-Fi Module

Installation of Wall Mount

Precautions

- For installation of the wall-mount bracket, at least two professional workers are needed; you should not attempt to install it alone, as this may result in injury.
- During installation, assistance from professional workers is needed to designate the installation, and measurements should be taken to ensure the wall can bear a certain amount of external force. Ensure the wall mount is installed on a wall or other surface that can provide strong support.
- This device should be installed on a vertical plane, not on an oblique plane; also, it should not be installed in a horizontal position; otherwise, damage to the device or personal injury may be caused.
- To avoid damage to the device or injury, keep the wall mount out of the reach of children.
- Tighten the screws during installation to avoid device damage and injury.
- The installation is shown in the figure below; ventilation space should be maintained around the device.

The Wall Mount is included in the package with the device.

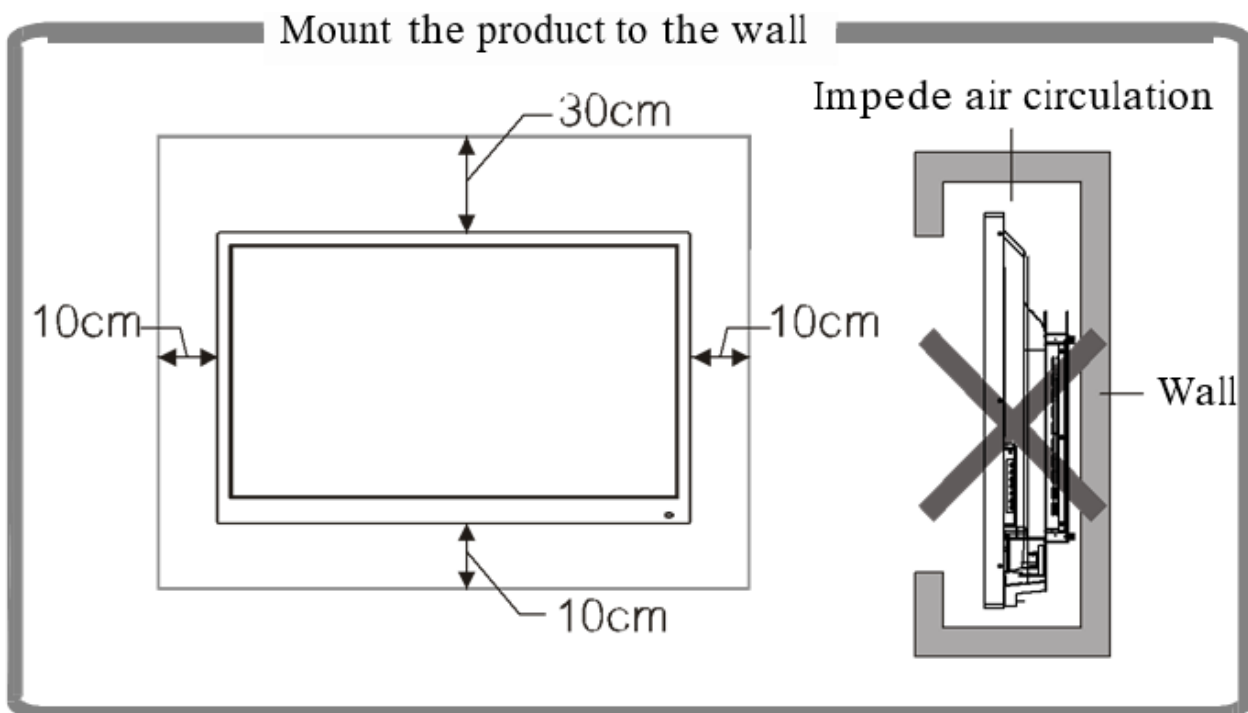





5. Remote Control

Precautions:

- Aim the remote control at the remote receiver when using the remote control. Any object placed between the remote control and the remote receiver may interfere with operation.
- Protect the remote control from vibration. Do not expose the remote control to direct sunlight, as heat may deform it.
- When the remote receiver is subject to direct sunlight or strong light, the remote control may malfunction. In such a case, change the angle of the lighting, reposition the device, or operate the remote control closer to the remote receiver.
- Replace the batteries in case of a low battery. Low battery power will reduce the range of the remote control. If the remote control is to be left unused for a long time or the batteries are depleted, remove the batteries, as battery leakage may damage the remote control.
- Do not use batteries of different types or mix a new battery with a used one. Always replace batteries in pairs.
- Do not throw the batteries into a fire, recharge, or disassemble the batteries. Do not recharge, short-circuit, disassemble/assemble, heat, or burn any used batteries. Dispose of waste batteries according to applicable environmental regulations. Do not expose batteries to any hot environment, such as direct sunlight or a fire.

Remote control button instructions:



| Button | Description |
|---|---|
| Power  | Switch between power ON and power OFF. |
| Input | Open/ close the signal source list. |
| Navigation keys < > ^ v | Select or adjust menu options. |
| OK | Confirm the operation. |
| Menu | Show/ Hide the main menu. |
| Home | Display the Android Homepage. |
| Back | Return to the previous interface. |
|  | Set the device into standby mode (backlight off). |
|  | QUICK launch button - NOTE. |
| Vol - | Decrease the volume. |
| MUTE  | Enable/ Disable sound. |
| Vol + | Increase the volume. |

Remote Control Use Instructions / Install Batteries

- 1) Open the back cover of the battery compartment on the back of the remote control.
- 2) Install AAA-type batteries according to the corresponding electrode, and make sure the battery's positive and negative poles are correctly placed ("+" to "+", "-" to "-"). Do not mix old and new batteries.
- 3) Close the back cover of the battery compartment after batteries are installed and snap the clip fastener shut against the bottom of the remote.

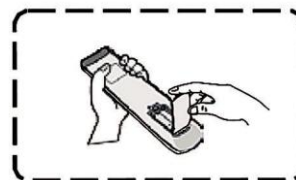
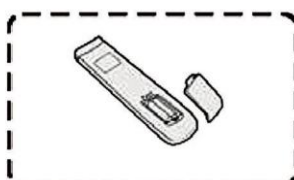
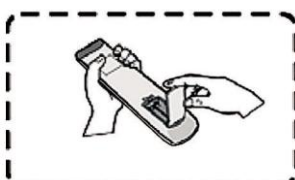

6. IFP Interface Inputs & Outputs

Right bottom side of the IFP interface:

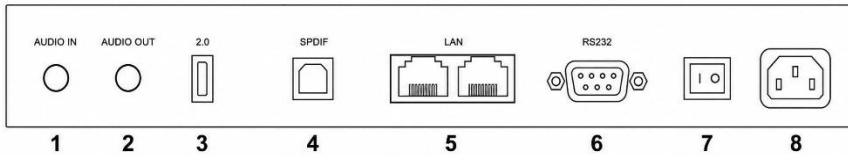

The right side of the IFP interface:

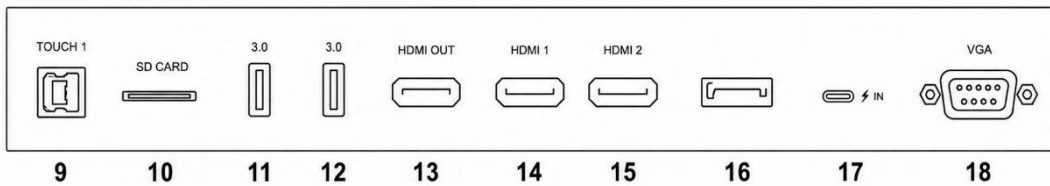

Right front side of the IFP interface:

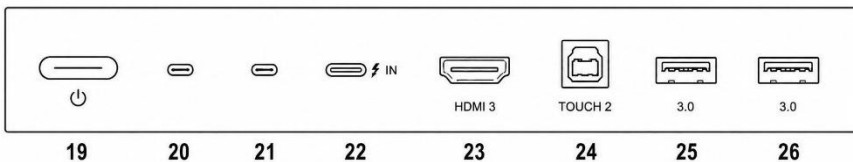

| Port | Function description: |
|-----------------------------|--|
| 1. AUDIO IN | External computer audio input. |
| 2. AUDIO OUT | Audio output - 3,5 mm connector. The Audio-OUT port can be connected to headphones or an external speaker. |
| 3. USB 2.0 | Connect USB devices such as portable hard drives, USB flash drives, USB keyboards, and mice, etc. This port is also used for firmware updates. |
| 4. SPDIF | SPDIF OUT – digital optical audio output. This port can output the device's audio signals to external speakers with an SPDIF-IN port. |
| 5. LAN | LAN interface for connecting RJ45 terminals. |
| 6. RS 232 | A serial interface is used for mutual transfer of data between devices. |
| 7. Main Power switch | The main power switch is used for quickly and completely disconnecting the device from the power supply. |
| 8. Power Input | Used to connect the display/device to AC mains power using a standard computer-style power cable. |

| | |
|--|--|
| 9. & 24. TOUCH USB | External computer touch signal input. The default touch function is available under the optional built-in OPS PC. When connecting an external computer, in addition to connecting the external computer's VGA and audio signals, the external computer's USB port needs to be connected to the equipment. Under the condition that the driver is installed, the external computer can be touch-controlled through the equipment (touch function is effective in PC, VGA, and HDMI channel by default). |
| 10. SD CARD | Supports SD memory cards for easy file transfer and media storage expansion |
| 11. & 12. USB 3.0 | Connect USB devices such as portable hard drives, USB flash drives, USB keyboards, and mice. |
| 13. HDMI OUT | For connection to external display devices with an HDMI input, such as monitors or projectors. Supports resolutions up to 4K@60Hz. |
| 14. & 15. & 23. HDMI IN | For connection to external devices with an HDMI output, such as laptops or media players. Supports resolutions up to 4K@60Hz. |
| 16. DP IN | For connection to display devices with a DisplayPort output function. The maximum resolution supported by the DP port is 4K@60Hz. |
| 17. & 22. USB Type-C | USB Type-C supports charging, data transfer, and expansion for audio and video output interfaces. (Please charge only external devices with the same or lower rated charging power. Do not attempt to charge laptops that require a higher charging power than the rated output of the USB Type-C port.) |
| 18. VGA Input | Input for video signal formats supported by the VGA port. |
| 19. Power Button | Turns IFP ON / OFF (when pressed for 1 second, IFP will enter standby mode). |
| 20. Signal Receiver | Remote control signal receiver. |
| 21. Light Sensor | Automatically identifies the brightness based on ambient light. |
| 25. & 26. USB 3.0 | Connect USB devices such as portable hard drives, USB flash drives, USB keyboards, and mice, etc. (The touch function is enabled by default in the PC, VGA, and HDMI channels). |

7. First Startup

First installation:

- 1.) Connect the IFP to a power outlet.
- 2.) Switch the main power switch to the ON position.
- 3.) The power button on the right side of the front panel will light up red – press it.
- 4.) The power button will change colour to white.
- 5.) You will see the startup screen with the Android logo.
- 6.) The welcome screen will load – follow the on-screen instructions.

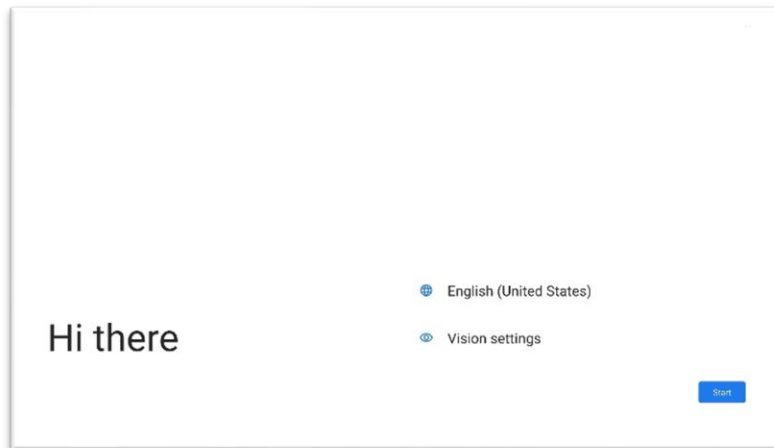

- a.) Click the globe icon and its associated button to select your language version (the default setting is English – this can be changed later).
- b.) Click the eye icon to adjust settings for the visually impaired (this can also be changed later).

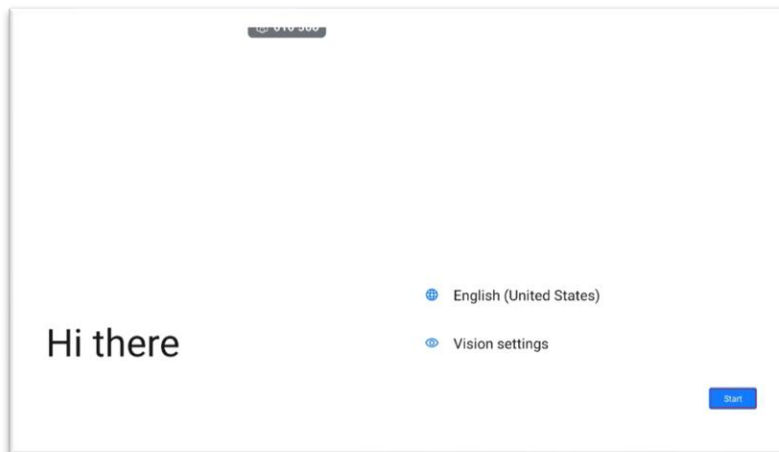

- c.) If you are satisfied with the settings, click *Start*.
- d.) If the device is not connected via a LAN cable, it will automatically detect a network if one is active. If you have inserted a Wi-Fi module (see page 27 for installation), a list of available networks will be displayed, provided the device is not also connected via LAN. The device setup can also be completed in offline mode. All logins and backups can be configured later.
- e.) If you are using a LAN connection, you can skip the following steps and proceed directly to point i).
- f.) Connecting to a Wi-Fi network: If the installed Wi-Fi module detects networks available in your area, click on the desired network. The device can also be connected to a different network later.

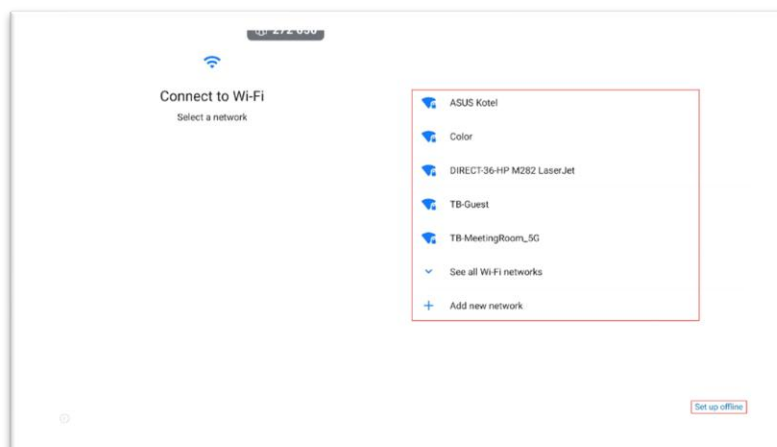

g.) After selecting the Wi-Fi network, a login dialog will open. Enter your network password in the field using the on-screen keyboard and press Connect. If the password is correct for the selected network, the device will connect to that network. If the password is incorrect, follow the instructions displayed on the screen.

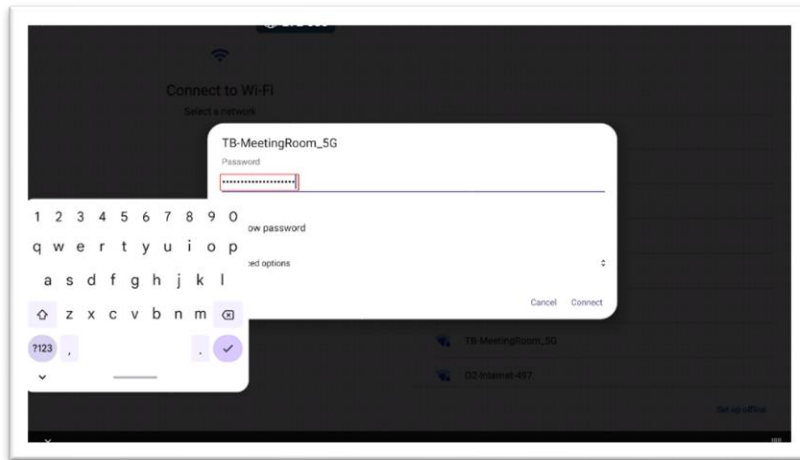

h.) The device setup will begin – please wait until it is completed.

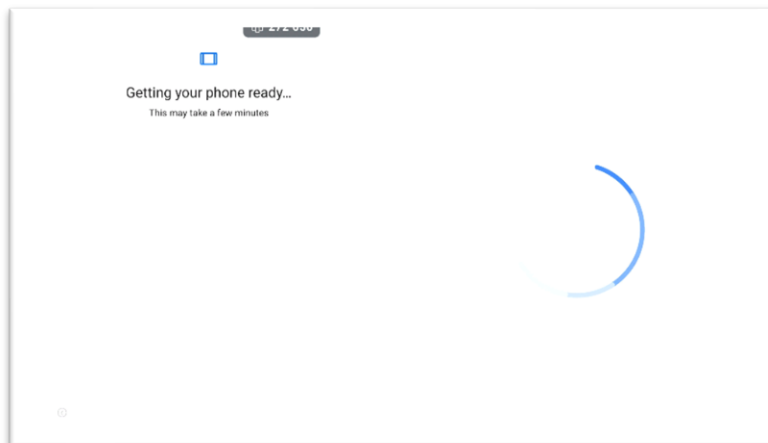

i.) Choose the option if you want to copy data from another device. If you do not wish to do so, press *Do Not Copy*.

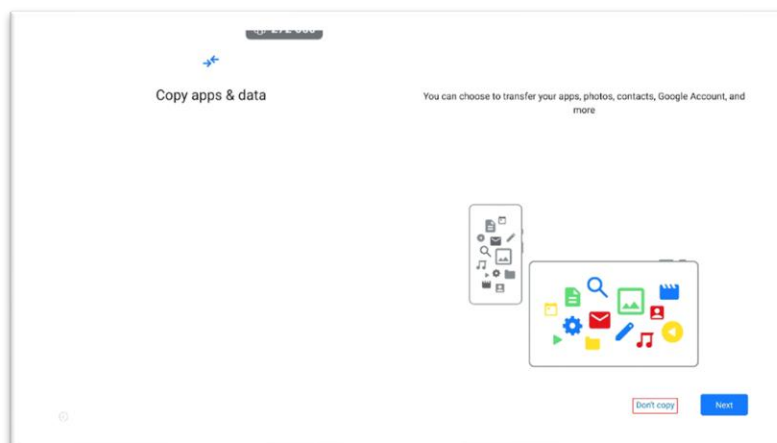

j.) Then the verification of the information will take place.

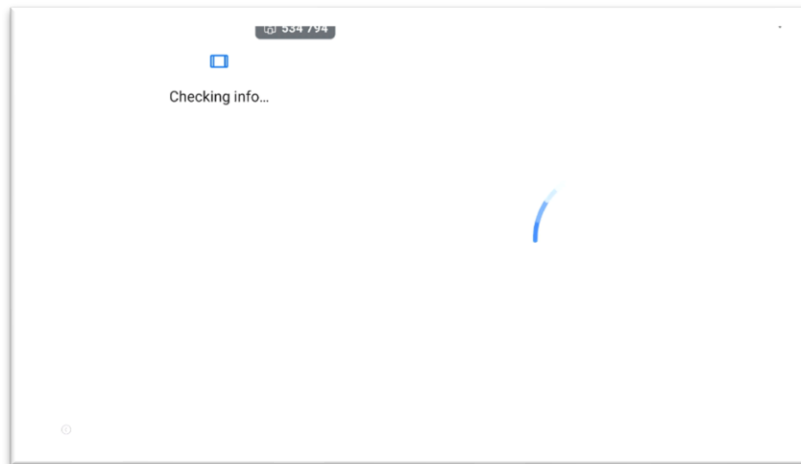

k.) Signing in to a Google account – this can be done later. It is required for downloading apps. If you don't have an account, you can create one. If you do not want to use an account with this device, select *Skip*. To enter an account, click on the dialog box, enter your account email, and press *Next*.

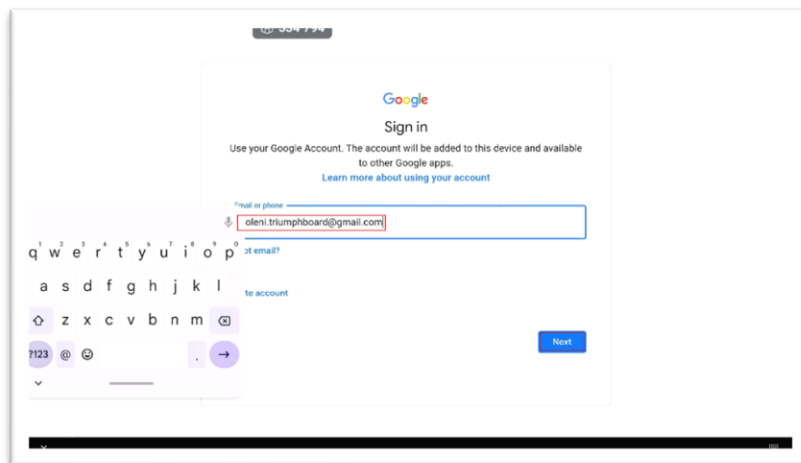

l.) If a valid active account is entered, enter the account password and click *Next*.

m.) The Google Terms of Service will be displayed. If you agree, click *I Agree*. If you do not agree, click *Do Not Add This Account Now*.

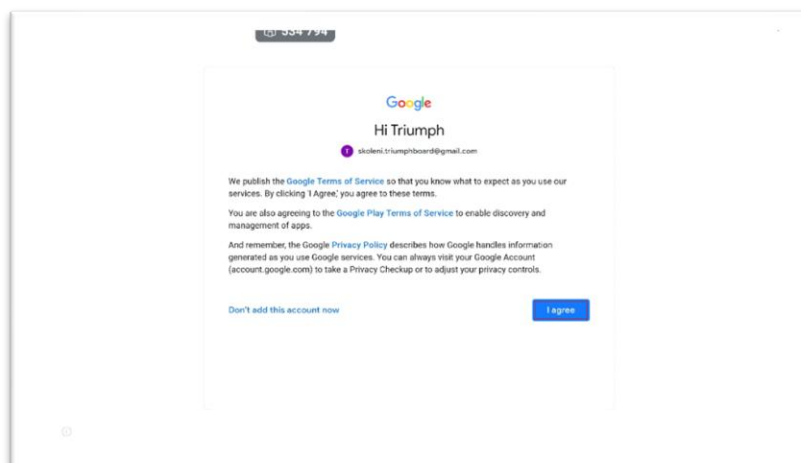

n.) The window for setting up Google services will follow. Choose the settings that are suitable for you, then click *Next*, and the window will move to the next part of the terms. Here, you must click *Accept*.

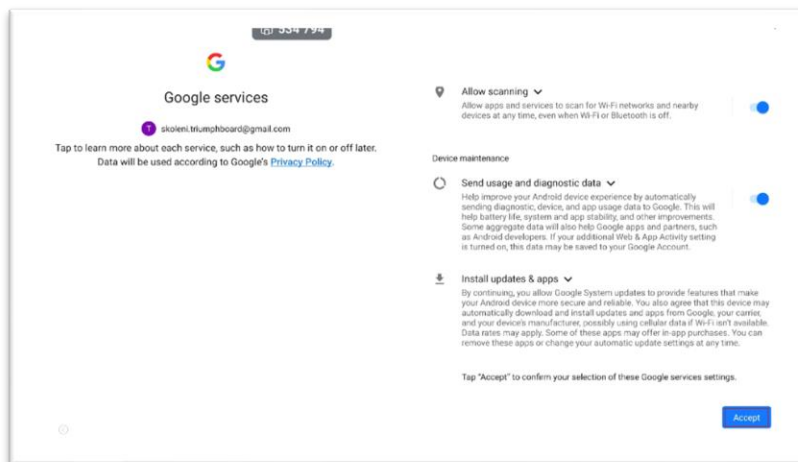
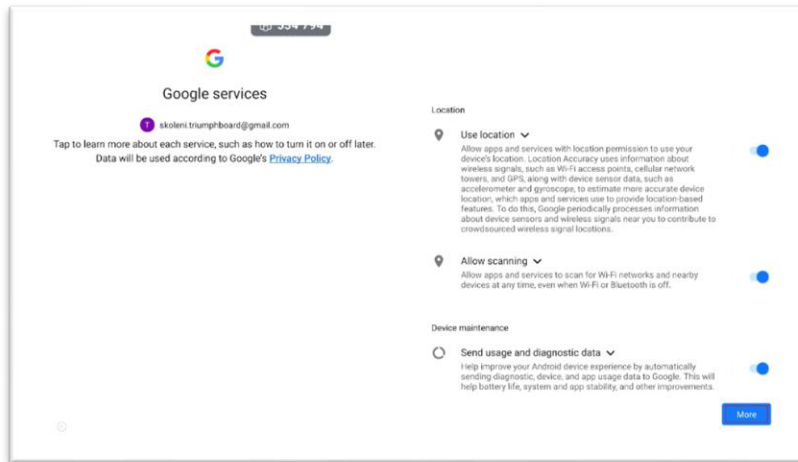

o.) Backup – In this dialog, decide whether you want to back up your data to your account or not. This setting can be changed later.

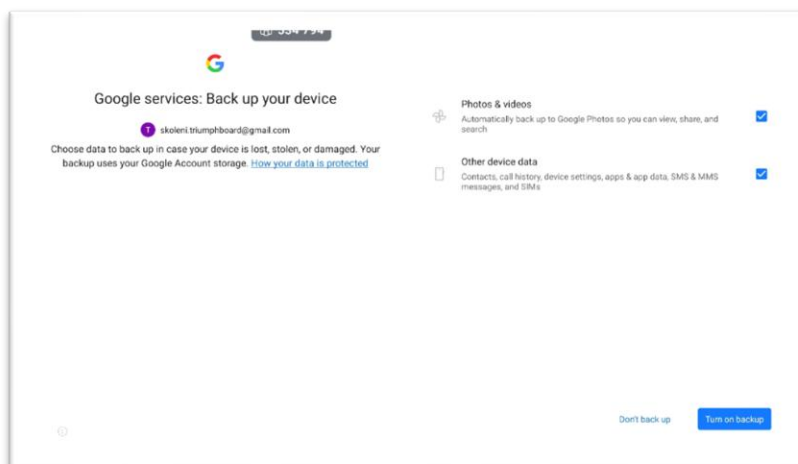

p.) PIN setup - set your PIN here. By default, you can create a 4–6 digit numeric PIN. Alternatively, you can choose another security method (pattern, PIN, password) by clicking *Screen Lock Options*. If you do not want any form of security (not recommended), click *Skip* at the bottom. After entering your PIN for the first time, you will be prompted to enter it again, and it must be *Confirmed*.

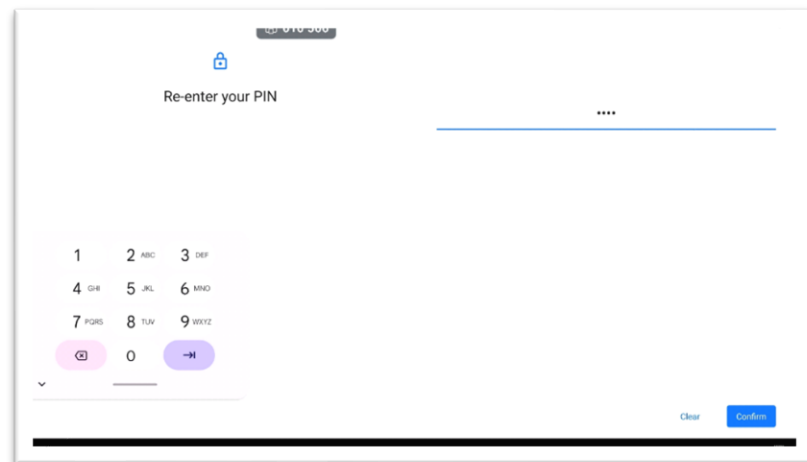
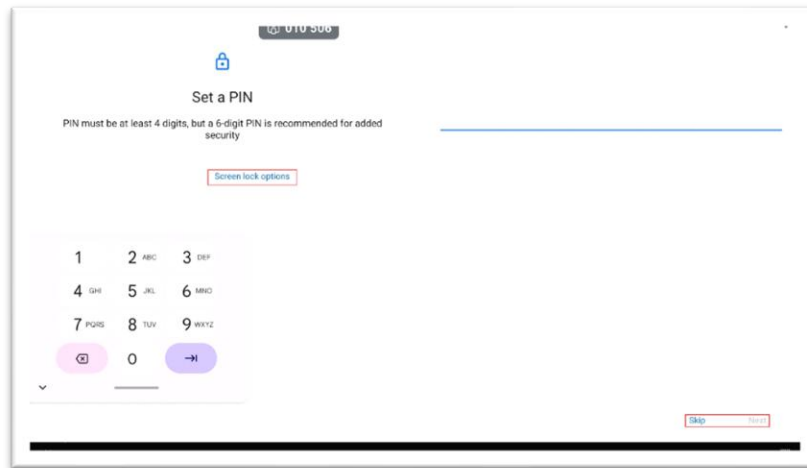

q.) Google Assistant Setup – In this setting, you can enable hands-free voice access by clicking *I agree*, or if you are satisfied with the current setup, you can also do this later by clicking *Skip*.

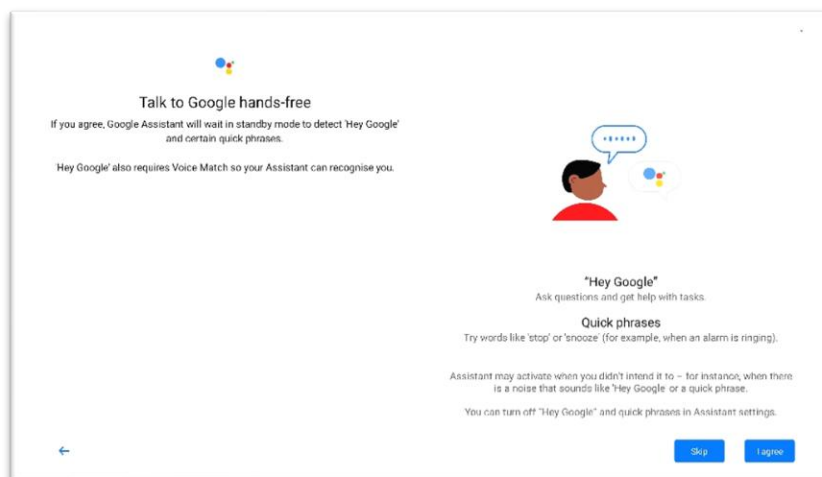

r.) Lock Screen Access – Enable Assistant on the lock screen by selecting I agree or Skip.

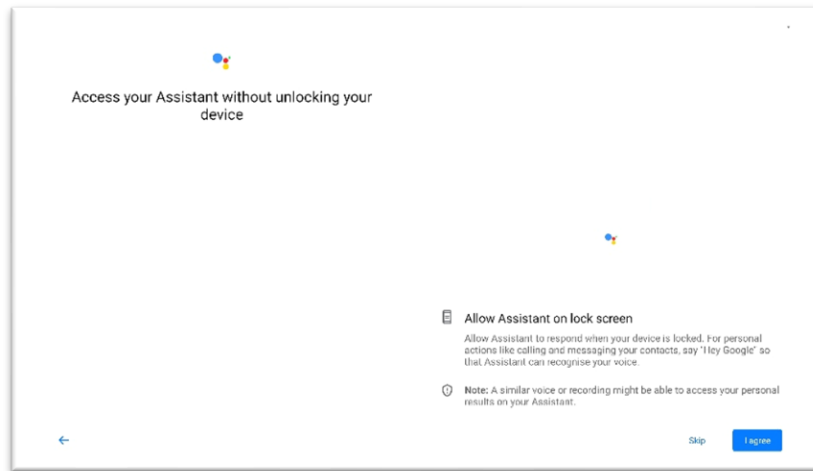

s.) Payment Setup - In this setting, you can link a payment card to your device. You can choose between *Add card* and *Skip*.

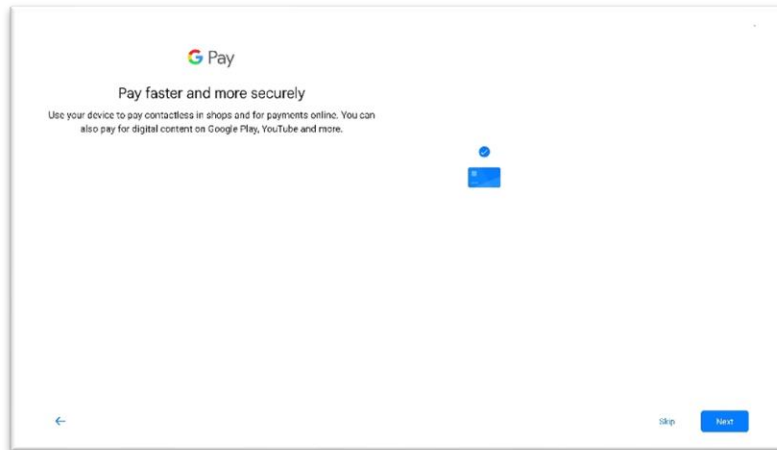

t.) What's Next – In this setting, you can add additional accounts and adjust settings. You can also do this later. If you are satisfied with the current setup, click *No, Thanks*.

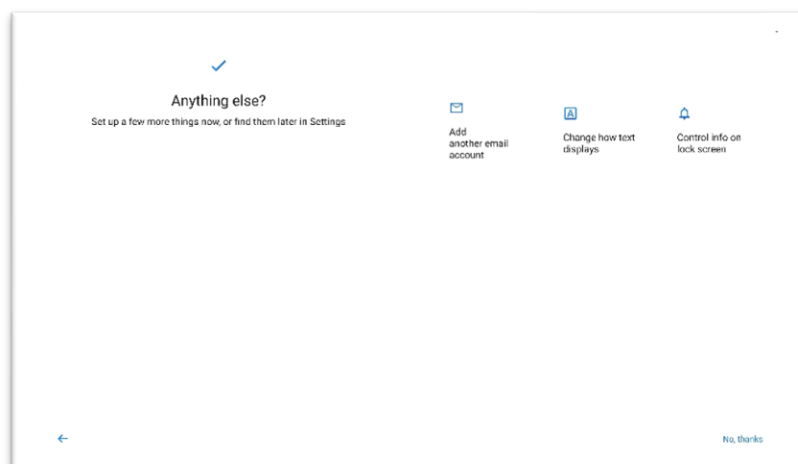

u.) Navigation Mode – select *Traditional* here. This ensures the best performance with specialized programs and applications, as you are accustomed to from previous models. Then click *Next*.

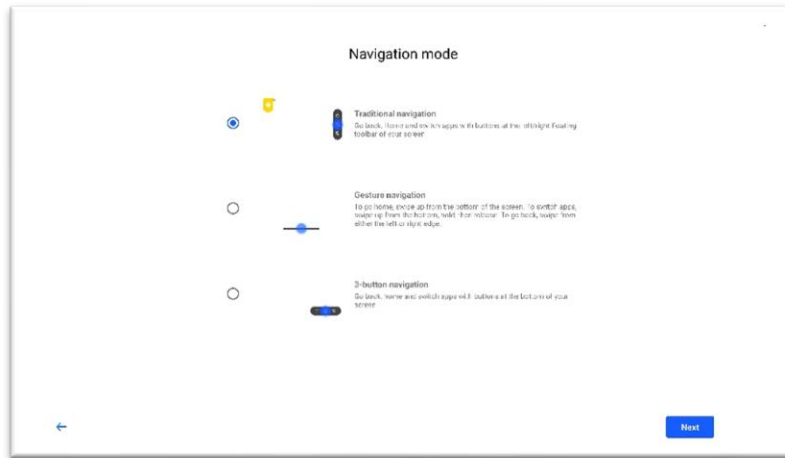

v.) Set your region by swiping up or down. Select the appropriate Region, then click *Next*.

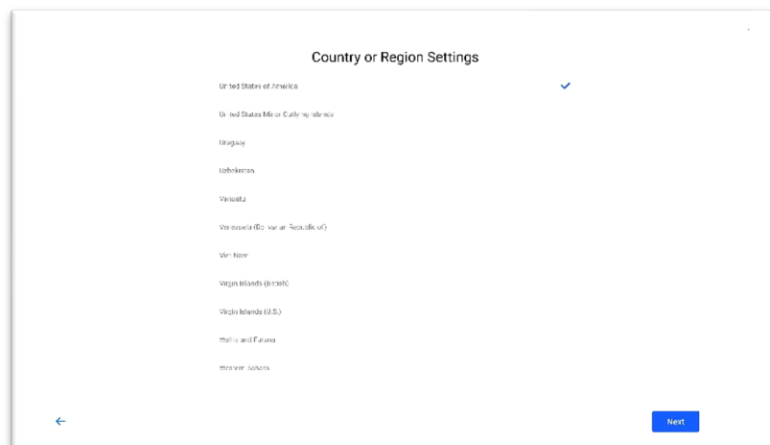

w.) Privacy Protection – click *Next*.

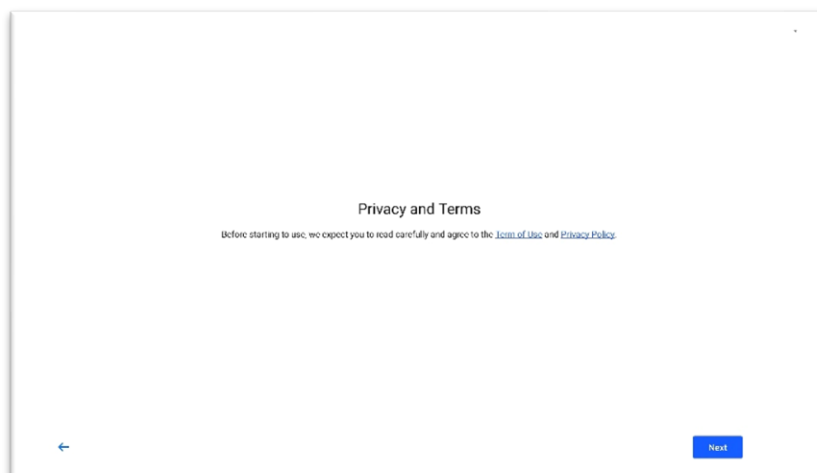

x.) AI service Terms – Review the privacy terms, then select I agree or Skip to continue

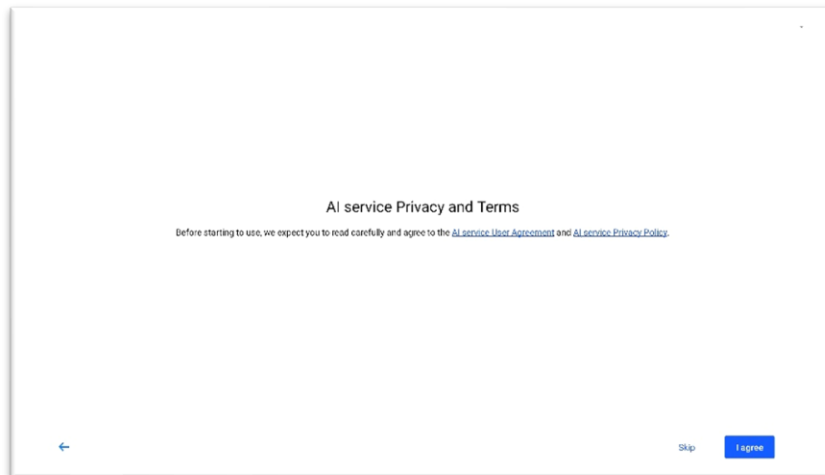

y.) After reviewing, confirm the additional user terms by clicking *Accept*.

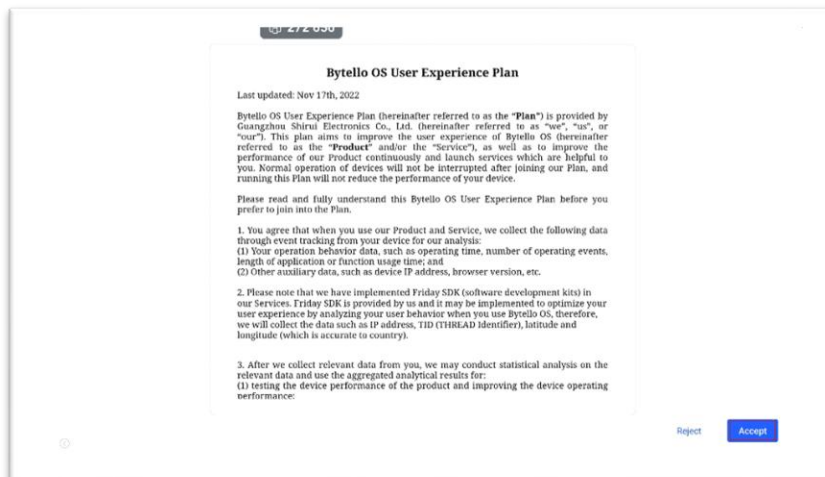

z.) You will then see the Android home screen. On the first startup, it may take a moment for the device to respond properly, as the installation process is running in the background.

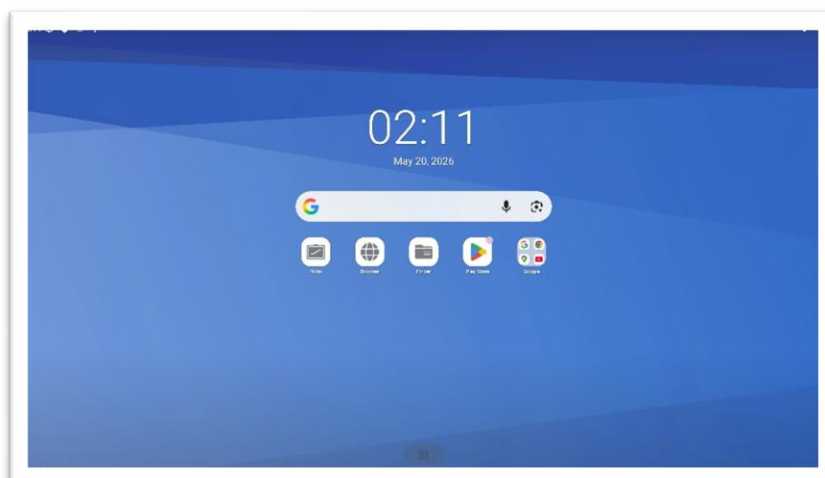

8. Setting a Screen Lock

1. Open the program list and select "Settings".

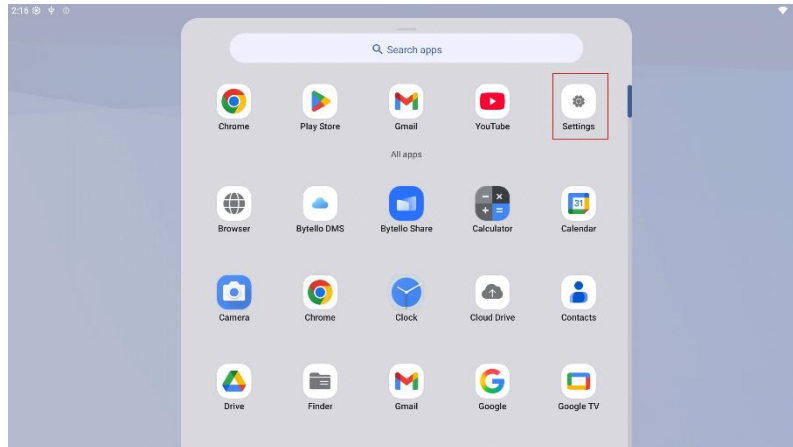

2. Select "Security & Privacy" and then "Device Unlock".

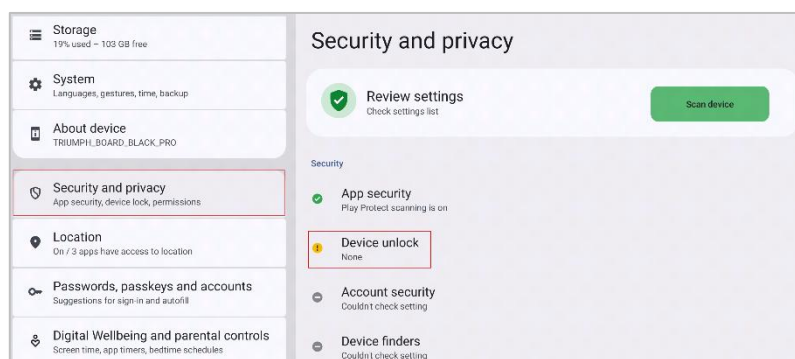

3. Select "Screen Lock".

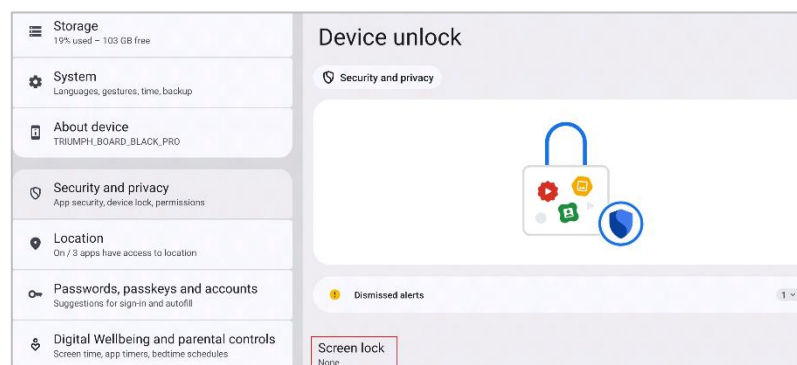

4. Choose your preferred lock method

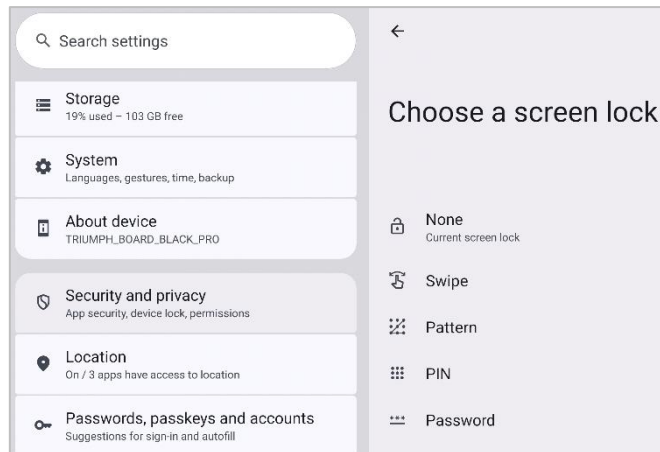

5. Enter and confirm your new password or PIN.

9. NFC

Before using an NFC card, a screen lock password or PIN must already be set.

1. Open the program list and select "Settings".

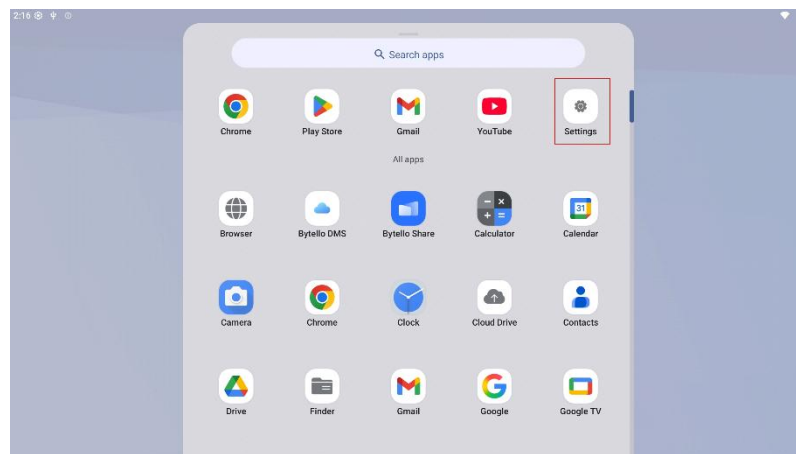

2. Select "System" and then "Users"

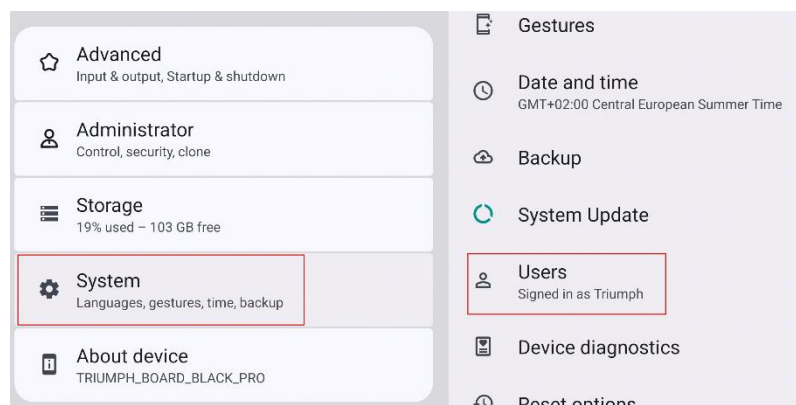

3. Select "Add NFC".

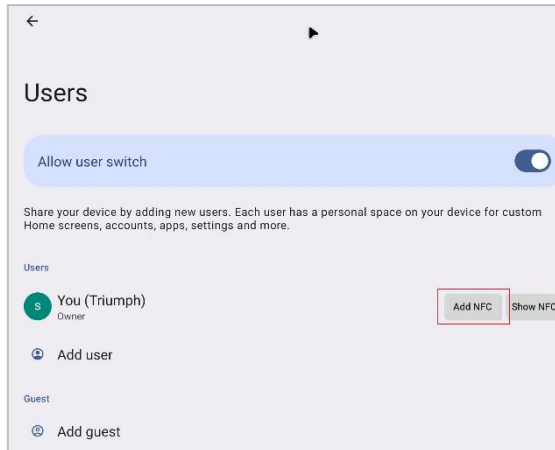

4. Hold the NFC card near the card scanner.

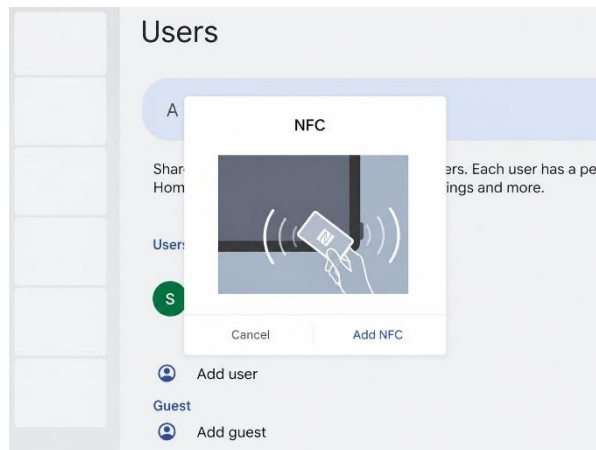

5. Wait until the NFC card icon turns blue with a check mark.

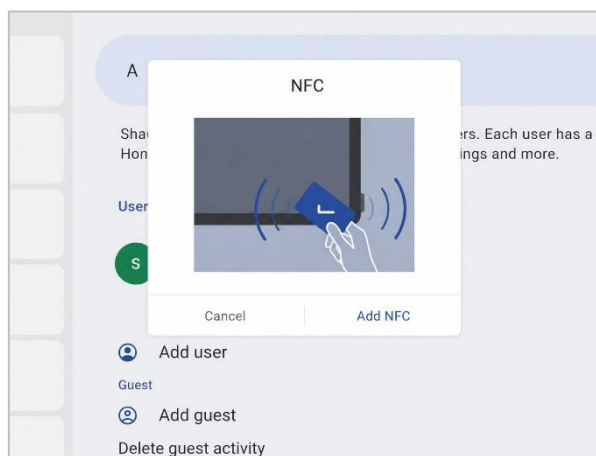

6. Remove the card and tap "Add NFC" to finish setup.

10. Setting Up the AI Stylus

1. Open the program list and select “Settings”.

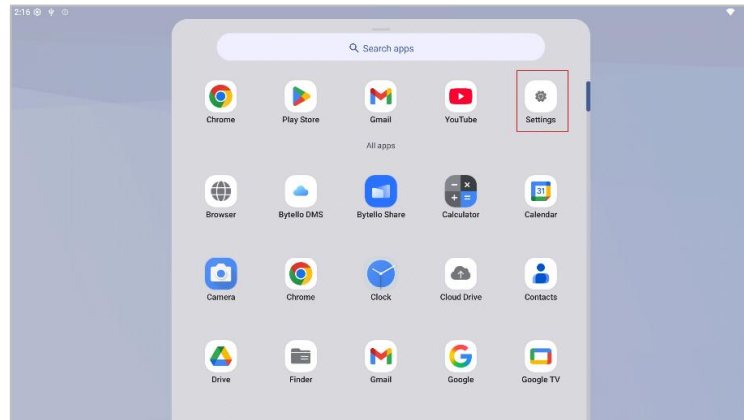

2. Select “Connected devices” and then “Connection preferences”.

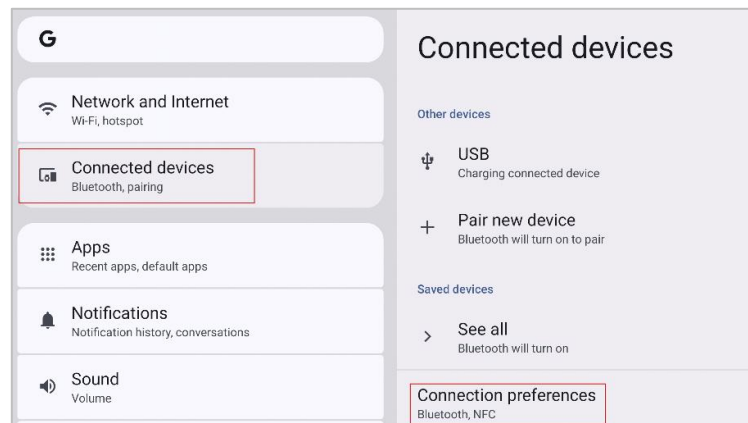

3. Select “Bluetooth”.

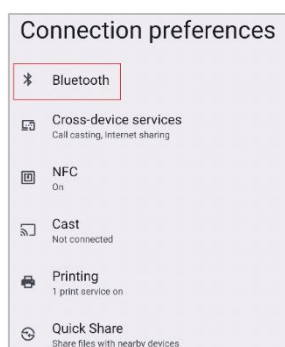

4. Tap “Pair new device”



5. Press and hold the two stylus arrow buttons (^ / v) for 5 seconds.
6. Wait for "AI Stylus" to appear in the device list.

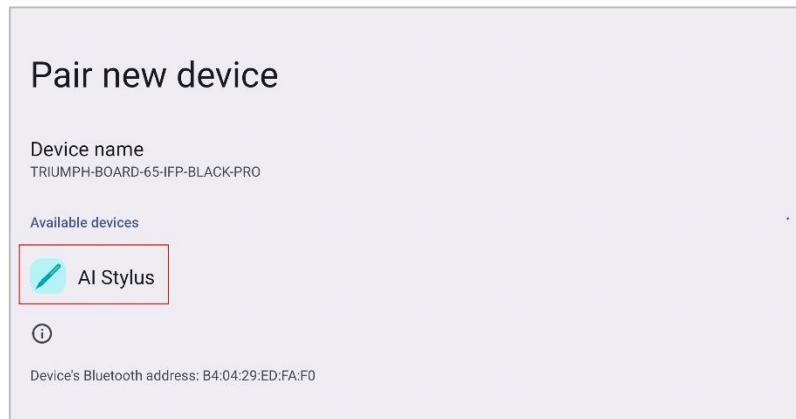

7. Select "AI Stylus" to complete pairing

11. Connection and Set-Up

CAUTION - For your safety and the device's safety, do not connect any power cord before the external device has been prepared.

External Computer and Touch Connection

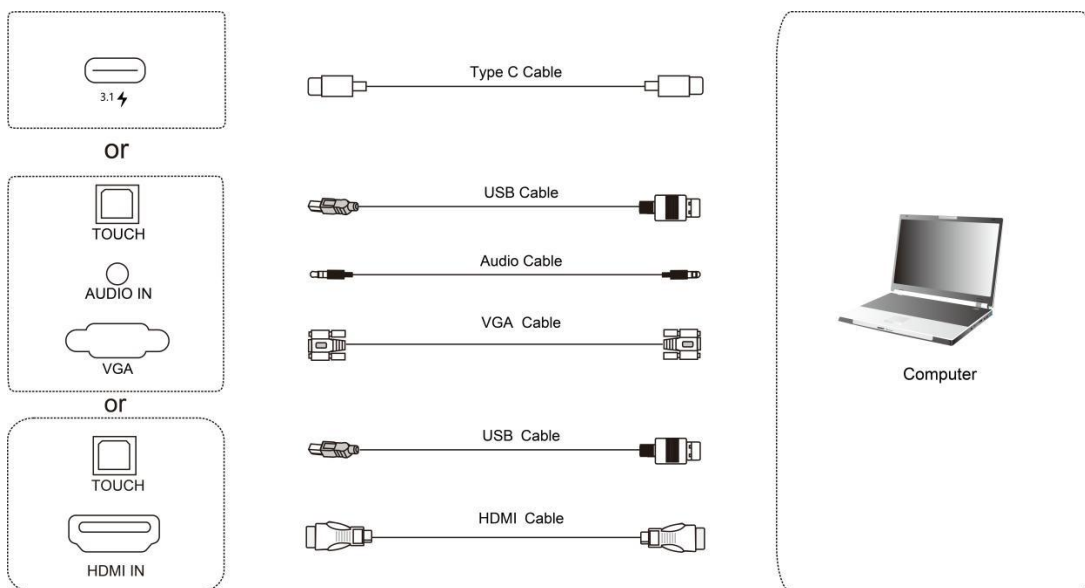

Connecting the VGA cable and the USB touch cable:

2. Use a VGA cable to connect the VGA output port of the external computer to the VGA input of the IFP.
3. Use an audio cable to connect to the audio output interface of the external computer.
4. Use a USB cable to connect the USB port of the external computer to the USB TOUCH port.
5. After a successful connection, plug in the power cable and switch the main power switch to the ON position.
6. Turn on the external computer.
7. Turn on the IFP using the button on the front panel or the remote control.
8. Press the INPUT button on the remote control and switch to the corresponding source: VGA, or select it from the input list in the Android interface.

Connecting the HDMI cable and USB touch cable:

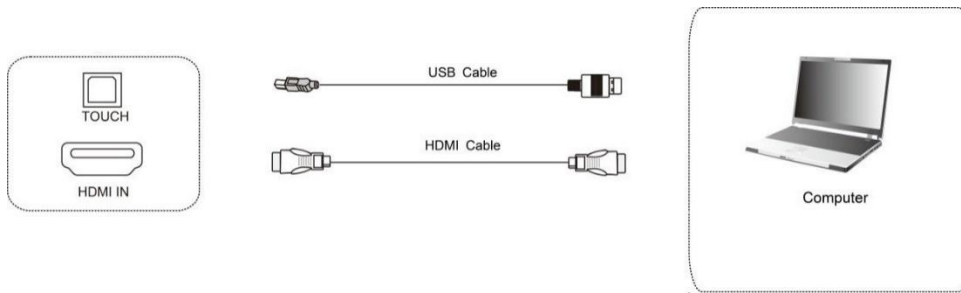

1. Use the HDMI line to connect to the HDMI output port of the external computer.
2. Use a USB cable to connect to the external computer USB port.
3. After the connection is complete, plug in the power cord and switch POWER to ON.
4. Start the external computer.
5. Press the key, and the equipment is powered on.
6. Press the INPUT key to switch to the HDMI channel.

Connecting the HDMI cable and the USB touch cable:

HDMI 1/2--> TOUCH USB 1
HDMI 3 --> TOUCH USB 2

USB-C connection for touch control:

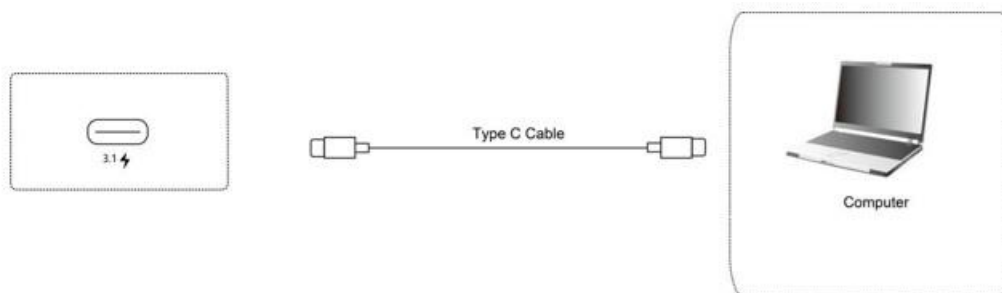

1. Use a USB-C cable to connect the USB-C port on the external computer to the USB-C port on the front of the IFP.
2. USB-C supports DisplayPort (max. 4K 60Hz), touch functions, and charging (60W) — support for these functions depends on the cable used and the specifications of the USB-C port on the external computer.
3. After completing the connection, plug in the power cable and switch the POWER to the ON position.
4. Start the external computer.
5. Press the power button to turn on the device.
6. Press the INPUT button on the remote control and switch to the appropriate source: TYPE-C, or select it from the input list in the Android interface.

RS232 Serial Port Connection

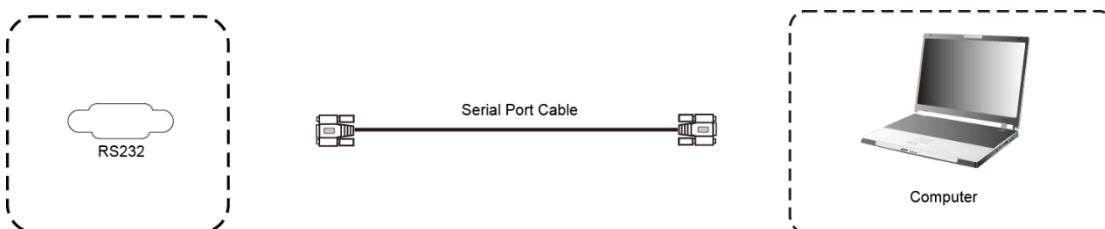

After connecting the computer to the device via the serial port, certain functions—such as power ON/OFF and volume adjustment—can be controlled through the central control system. RS232 codes are available on our support webpage: <https://www.triumphboard.com/support/>.

LAN Connection

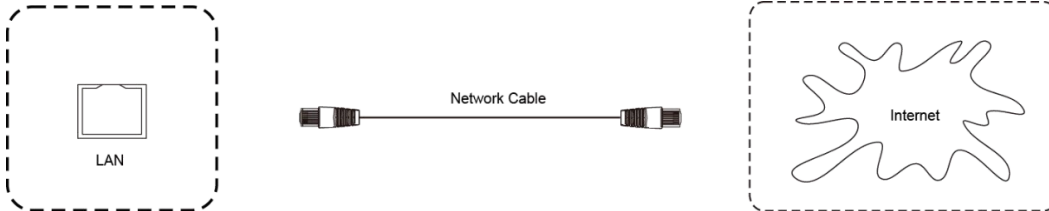

USB connection

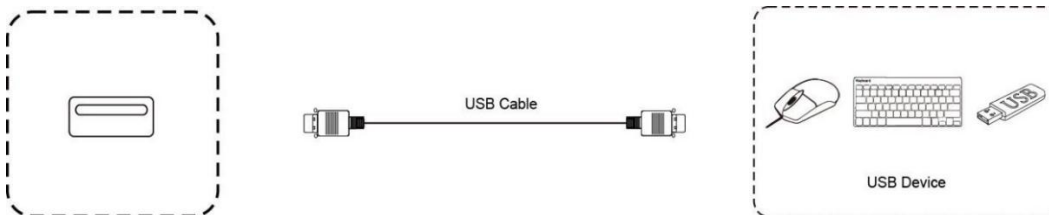





12. Android System

Activation of Control Menu











There are 2 arrows on the screen (3 – can be activated in the menu) that are used to bring up the control menu. One is located on the left side and one on the right side of the screen. The control menu automatically hides after 5 seconds of inactivity or when pressing the ◀ / ▶ buttons on the displayed toolbar. In the default settings, swiping up from the middle of the bottom edge brings up the device input menu, also called the Common Settings menu.



Control Menu

| | | | |
|---|--|---|-------------------|
|  | Home (Return to Android Home Page) |  | Note (Annotation) |
|  | Switcher (Switch through open apps and Inputs) |  | Browser |
|  | All apps (All installed apps) | | |

Widgets (Mini-Apps):

| | | | |
|---|--|---|--|
|  | Crop (Crop screen & screenshots) |  | Mark (Annotation on glass) |
|  | Timer |  | Stopwatch |
|  | Record (Recording of the screen) |  | „Freeze“ (allows you to take a temporary screenshot and zoom in/out on the display area) |
|  | Inputs (switching between different sources) |  | Screen Lock |
|  | AirClass (Online Voting System) |  | Spotlight (highlights the selected portion of data on the screen) |
|  | Bytello Share | | |

13. Basic Operations

Start-up/ shutdown

Use an AC power outlet with 100-240 V as the power source. The main power switch is located on the underside of the device and must be set to the “I” position when turning the device on. For extended inactivity, it is recommended to switch it to the “0” position.

The power button on the panel or the remote control can be used to turn the device on or off. Pressing the power button on the front panel once will put the device into Standby mode, in which the panel backlight is off, but the device remains ready for immediate use (the LED blinks red). To fully turn off the device, when it is powered on, press and hold the power button for about 3 seconds until the shutdown dialog appears.

Automatic shutdown

In the main Android interface, the device will never power off automatically, regardless of whether a signal is present on other inputs. In any interface other than Android, the device will automatically turn off if no connected device is detected on the input for 5 minutes.

Saving settings before shutdown

Before powering off, the device saves the image and sound settings, which are restored when it is turned back on.

Switching between sources

You can switch the source using the remote control or the icon  by the following methods:
By pressing the **INPUT** button on the remote control, the “**Signal Source List**” will appear. Use the arrow buttons on the remote to select a signal source, press **OK**, and the device will switch to the selected input source.

Second method: Press the Input Settings icon in the top-right corner.  Or select it from the control menu. The Input Settings will appear; choose the input you want to switch to, and the device will switch to the selected input source.

Display Settings

Open Settings  > click the three dots > Display and adjust the display frame backlight, colour temperature, aspect ratio, picture mode, saturation, etc. (adjustable only on inputs other than an Android system).

Audio settings

Open Settings  > Click the three dots > Sound and adjust the volume, bass, treble, output audio device, etc.

Screen Lock/ Password settings

Go to Settings > System > Screen Lock Password. Set the desired four-digit password. The password can be changed after entering the initial password in the password settings. If you forget your password, contact after-sales service (see page 34) for instructions on how to reset it. The screen lock can then be activated by opening the control menu and pressing the Screen Lock icon. 

Screenshot

Open the side control menu and select Crop. The screenshot will be saved to the folder “\Notes\Mark” in the local file manager. 

14. Wi-Fi Module

Installation procedure

The Wi-Fi module is included as an accessory and needs to be installed.

Warning: Make sure the power cord of the Interactive Flat Panel (IFP) is disconnected before installation.

1. Locate the slot cover at the bottom centre of the device and remove it by unscrewing it.

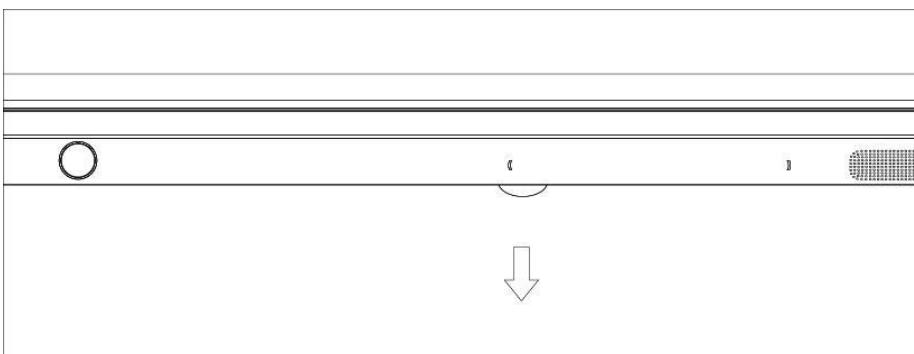

2. Fully insert the Wi-Fi module. If you are facing the screen from the front of the IFP, insert the module so that you can see the arrows pointing upward, and insert the module into the device in this orientation.

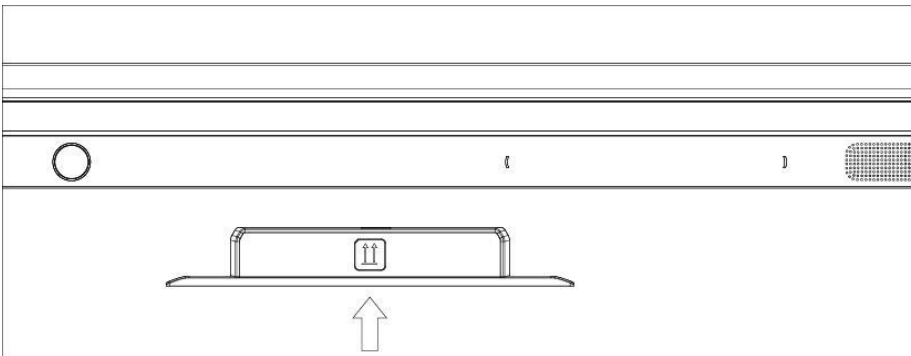

3. Press the module into the slot to complete the installation.

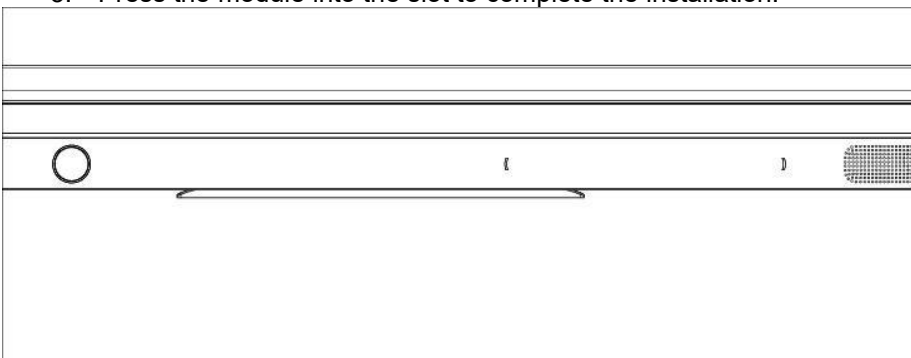

Note: This Wi-Fi Module only works for the IFP by plugging it into the above slot

Function

After completing the installation, turn on the IFP, and the Wi-Fi Module will run automatically. Click "Settings" on the screen, and you can see the following interface.

15. Network Settings

Wireless Network

1. Settings > Network & Internet > WLAN

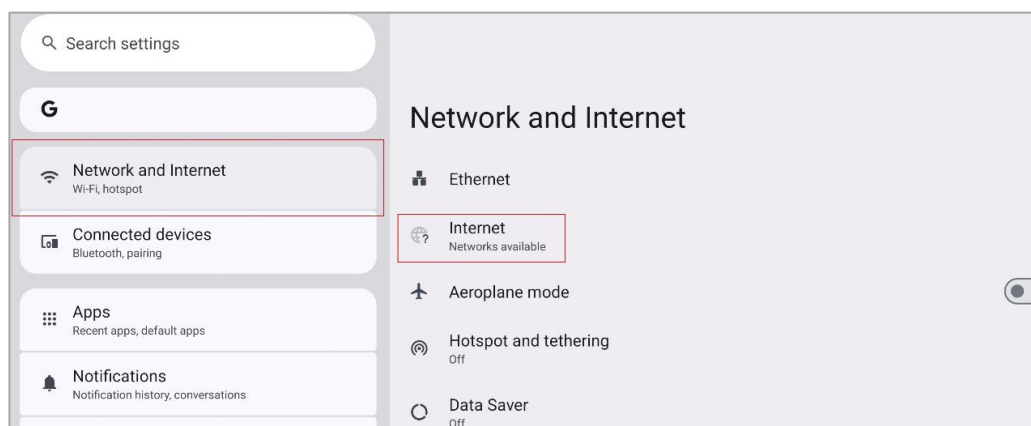

2. Turn on the Wi-Fi switch

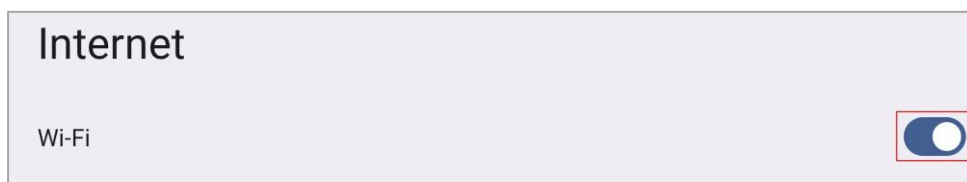

3. Select the network to be connected to from the Network List, enter the connecting password, and press connect.

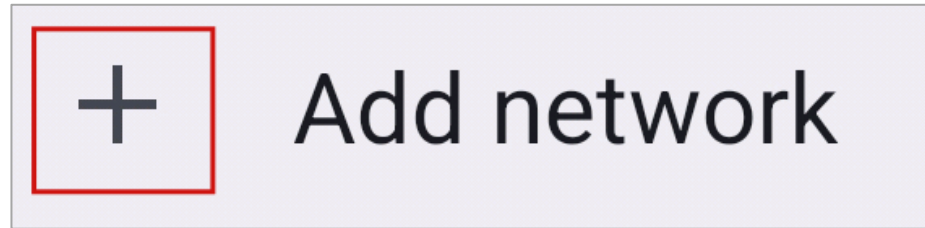

4. If there is no desired network in the Network List, manually add a network.

This Wi-Fi adapter is intended only for use in Android mode.

Wireless Hotspot

The wireless hotspot only works if the following conditions are met. The Wi-Fi module is built in and plugged into the appropriate slot in the IFP. The Wi-Fi module operates in either wireless network connection mode or hotspot mode. If the device is not connected via LAN cable, then other connected devices, including the IFP, will lose the ability to access the Internet. Data sharing via AirPlay/Bytello Share will be possible. Without a connected LAN cable, the connected devices will not be able to access the online content.

1. Select Settings > Network & Internet > Hotspot

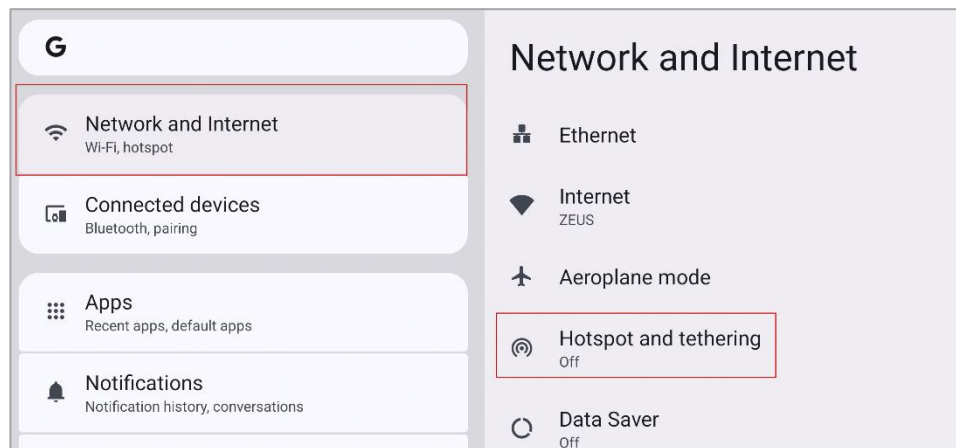

2. Turn on the hotspot feature (activation may take a few seconds)

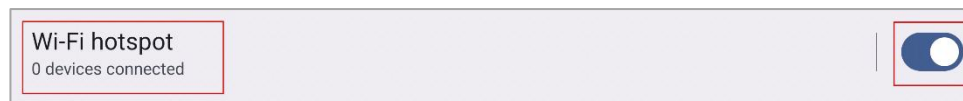

3. Enter the hotspot name in the textbox. The default name is "TRIUMPH-BOARD-??-IFP-BLACK-PRO", which is customizable.

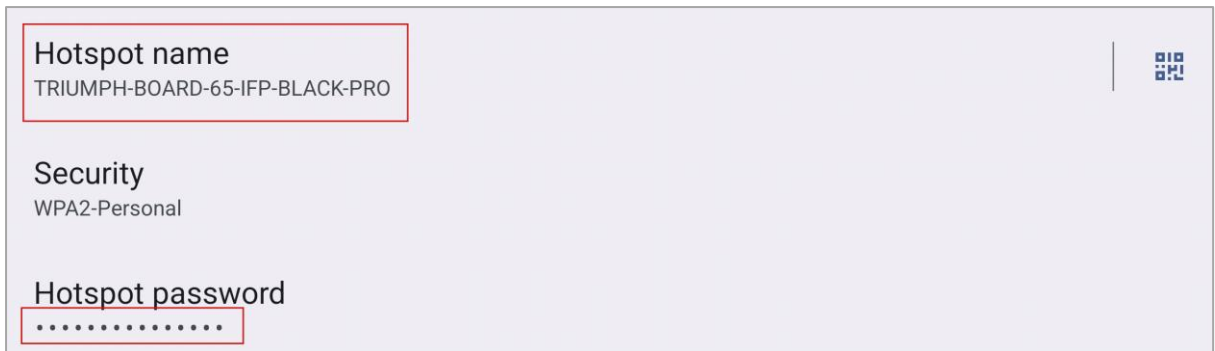

4. Enter the hotspot password in the textbox. The default password is shown by selecting on “Hotpost password”. The password is customizable.

Ethernet

There are two LAN network ports on this device; LAN 1 can be used to connect to a wired network. When one network port is connected to a router, the other port can be connected to an external device. The device’s Android system, OPS (Windows system only), and the external device form a LAN, which can be connected to the network simultaneously.

1. Connect one end of the network cable to the network port of this device before using a wired network, and then connect the other end to a router.
2. Select Settings > Network & Internet> Ethernet

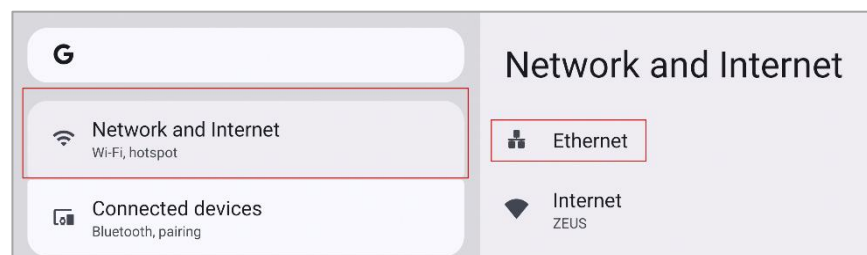

3. Turn on the connecting switch

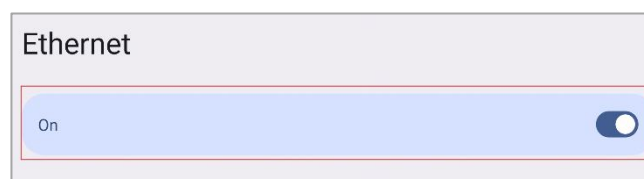

4. Select “DHCP” in IP settings. IFP automatically obtains an IP address and connects to the network.
5. Select “Static” in IP settings, manually input the IP address, gateway network prefix length, the DNS address, and then click “Save” to connect to the network.

16. OTA Update

Android System Firmware Update

For an online OTA update, connect the device to the internet via Wi-Fi or LAN cable. Then go to Settings → System → System Update → Check for Update. If a new update is available, you will be prompted to update the device. Follow the on-screen instructions to install the latest Android system firmware. Always ensure that the latest Android firmware is installed.

If you are unable to connect the device to the internet or have limited network access, please contact technical support. They will provide the firmware for installation via USB. The contact details can be found on page 34.

1. Open the program list and select “Settings”

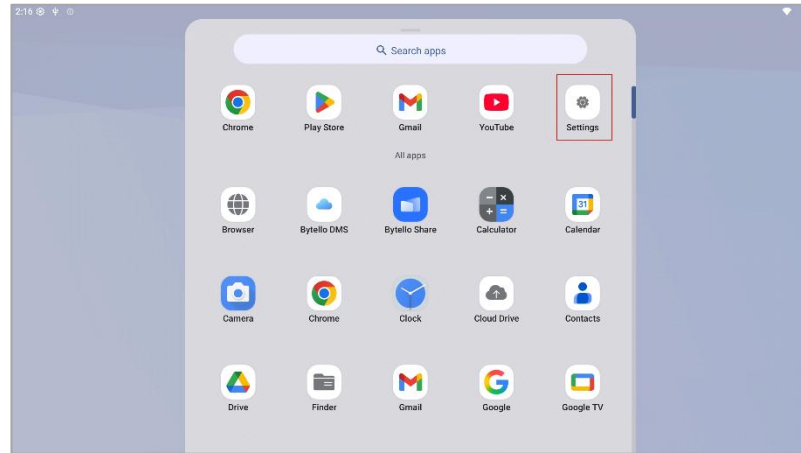

2. Select “System” and then “System update”

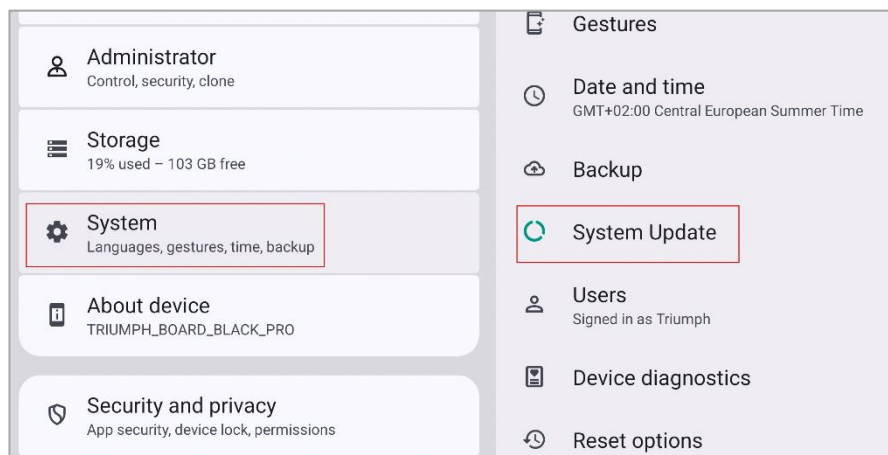

3. Select “Check Update”

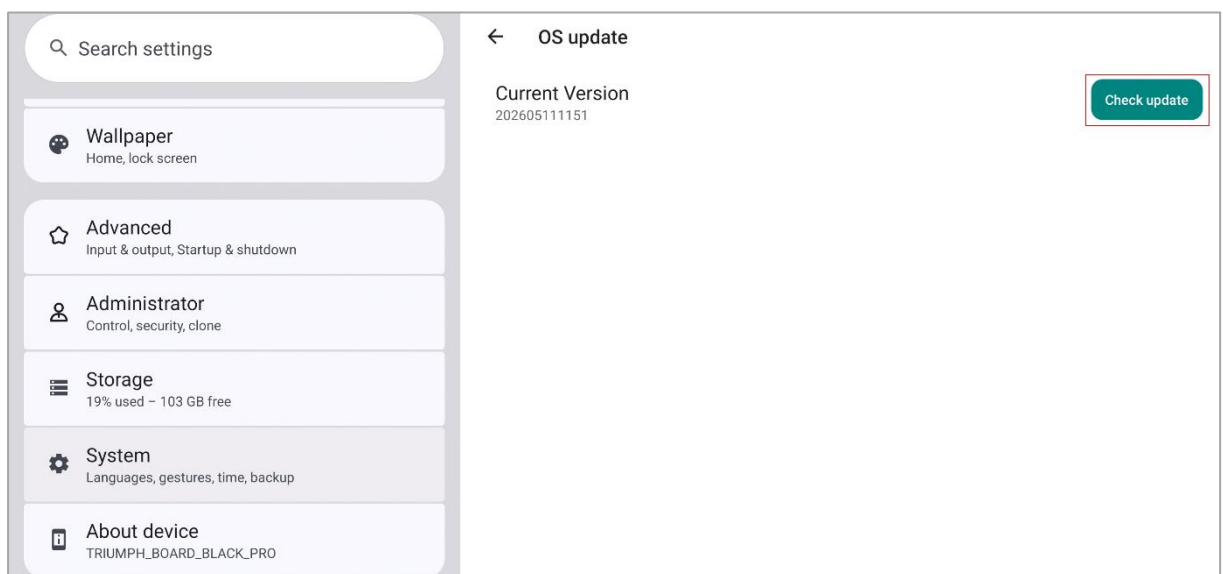

4. If a new update is available, start with a download and follow the steps for installation.

17. Troubleshooting

IFP fails to work normally

| | |
|--|--|
| Remote control failure | <ol style="list-style-type: none"> 1. Check whether there are other objects between the remote control and the television remote control receiving window, blocking signal transmission and thus leading to the failure of the remote control. 2. Check whether the battery terminal in the remote control is correctly connected. 3. Check whether the remote control needs a battery replacement. |
| Device automatically shuts down | <ol style="list-style-type: none"> 1. Check whether the No Signal Auto Shutdown is set or not. 2. Check whether there has been a sudden power outage. 3. Check whether there is no automatic shutdown. |

PC Module

| | |
|--|---|
| Signal out of range | <ol style="list-style-type: none"> 1. Check whether the display is set correctly. 2. Check whether there has been a sudden power outage. 3. Adjust line and field synchronization in the menu. |
| Image lacks colour, colour is incorrect | <ol style="list-style-type: none"> 1. Check whether the video cable is possibly not securely connected or has a quality problem. 2. Adjust colour and brightness or contrast in the menu. |

Touch Function

| | |
|---|--|
| Touch function invalid | <ol style="list-style-type: none"> 1. Check whether the touch driver is installed and running 2. Check whether the size of the article touch is comparable to a finger |
| Touch positioning is not correct | <ol style="list-style-type: none"> 1. Check whether the driver is properly installed and make the correction 2. Make sure your finger or stylus is making good contact with the touch screen |

Video Malfunctions

| | |
|--|---|
| No picture and no sound | <ol style="list-style-type: none"> 1. Check whether the device is in active mode. 2. Check whether the signal wire is plugged in securely, using the corresponding INPUT. 3. If in internal computer mode, check whether the internal computer is running. |
| With horizontal or vertical stripes or image distortion | <ol style="list-style-type: none"> 1. Check whether the signal wire is securely connected 2. Check whether other electronic equipment or power tools are placed around the device |

| | |
|---|--|
| <p>No colour, colour is weak, or the image is weak</p> | <ol style="list-style-type: none"> 1. Adjust colour and brightness or contrast in the menu. 2. Check whether the signal wire is securely connected |
|---|--|

Audio Malfunctions

| | |
|--|--|
| <p>Image, but no sound</p> | <ol style="list-style-type: none"> 1. Check whether the mute button is pressed for mute. 2. Press VOL. + / - to adjust volume. 3. Check whether the audio line is connected correctly. |
| <p>Only one speaker has sound</p> | <ol style="list-style-type: none"> 1. Adjust the sound balance in the menu. 2. Check whether the computer sound control panel only sets up one sound channel. 3. Check whether the audio line is connected correctly. |
| <p>VGA output without sound</p> | <ol style="list-style-type: none"> 1. Check whether an external device is connected via the headphone jack. |

18. Maintenance

Proper maintenance can prevent many early malfunctions. Regular, careful cleaning can keep the device brand new. Unplug the power plug before cleaning and maintenance, to prevent electric shock.

Cleaning of the screen

For cleaning, we recommend using special cleaning wipes designed for monitors or a soft microfiber cloth, ideally moistened with distilled water or a special screen cleaner. Avoid using abrasive cleaners, alcohol, acetone, or ammonia, as they may damage the surface, and especially avoid liquid sprays that could seep into the frame with the touch system. When cleaning, do not press the screen too hard and always use the dry side of the cloth to finish drying.

Cleaning of the front frame

Use a dry, soft, lint-free cloth to wipe the front frame.

The device is to remain unused for an extended time

If the device will not be used for an extended time, such as during vacation, make sure to unplug the cord to prevent any possible dangers caused by power surges from lightning.

19. Repair Service and Contacts

Warranty:

Contact your local dealer regarding warranty options in your territory.

You can find our standard warranty conditions on our website:

www.triumphboard.com/support/warranty

Technical support:

Fill in your RMA or Product question on our website:

<https://www.triumphboard.com/support/technical-support/>

TRIUMPH BOARD a.s.

Neklanova 122/15
128 00 Prague 2
Czech Republic

www.triumphboard.com

Notices:

Every effort has been made to ensure all information contained in this user guide is correct, but the accuracy or completeness is not guaranteed. Before using this device, you must evaluate it and determine if it is suitable for your intended application. You assume all risks and liability associated with such use. Any statements related to this device not contained in this manual or any contrary statements appearing on your purchase order shall have no force or effect unless expressly agreed upon, in writing, with this company.

Reproduction or reprinting of this user guide or any part without permission is prohibited.

The content of this user manual is subject to change without prior notice.