

User Manual v 2.3

MULTI Touch LED LCD

55" / 65" / 70" / 84"



July 2015

Contents

1. Product Description	4
2. Technical Specifications	5
3. Safety Warning	9
Placement	9
Power Supply	9
Screen	9
Range of Visibility	9
Temperature	9
Humidity.....	9
Ventilation.....	10
Headphones	10
Standby.....	10
Battery.....	10
Caution.....	10
4. Preparing for Installation	11
Unpacking.....	11
Accessories.....	11
Control Panel.....	12
5. Terminal Interface	13
6. Remote control	14
Remote control button instructions	14
Detailed function description of remote control buttons	15
Remote control use instructions.....	16
Install Batteries	16
Range of remote control	16
7. Connection and Settings	17
External Computer and Touch Connection.....	17
Audio and video equipment.....	18
AV	18
HDMI1 / HDMI2 / HDMI3 (MHL) / HDMI4 (4K2K)* *TRIUMPH BOARD 84" LED LCD	18
Coaxial connection	19
Video output connection	19
VGA output connection	19
USB Equipment connection	20
Network cable connection	20
Microphone connection	20
WAN connection	20
USB equipment connection.....	21

8. Menu Operation.....	22
One Touch menu operation	22
Settings menu	22
Input setting	22
Brightness setting	23
Volume setting	23
Zoom setting	24
Screen setting	25
9. More Settings (advanced settings).....	26
Advanced settings menu	26
Annotation menu	27
10. Android System Interface	28
Main Interface.....	28
TB Finder	28
Browser.....	29
PIP	30
Settings.....	31
Apps	31
TB Comenius Lite	32
11. Multimedia File Playback Interface.....	32
Image play.....	32
Audio play	33
Single play	33
Video play.....	33
12. VC Camera Bracket installation.....	34
13. Troubleshooting.....	35
14. Software protocols	36
15. Maintenance	41
16. Display mode.....	42
17. Repair Service and Contacts	42

1. Product Description

TRIUMPH BOARD MULTI Touch LED LCD Series

TRIUMPH BOARD MULTI Touch LED LCD is a fully integrated, professional, multi touch FULL HD / 4K⁺ LED LCD. The IR LED optical technology enables ten finger touches simultaneously using fingers, stylus or even a pointer.

TRIUMPH BOARD MULTI Touch LED LCDs are an effective presentation tool to show pictures, data, presentations, thoughts, ideas and business forecasts interactively. Engage the audience with the presentation with direct control of the computer through the LED LCD MULTI Touch.

TRIUMPH BOARD MULTI Touch LED LCD – no need for a projector! Easy installation! No limitations caused by light conditions! Elegant and stylish appearance!

TRIUMPH BOARD MINI PC6A / PC7A for MULTI Touch LED LCD Series (optional)

TRIUMPH BOARD MINI PC6A / 7A is a powerful, fully integrated personal computer for TRIUMPH BOARD LED LCD MULTI Touch Series.

TRIUMPH BOARD MINI PC6A / 7A is equipped with Intel i5 / 7 processor, integrated / independent graphics and 4 / 8 GB RAM, which ensures high power for running current software. 500 / 1000 GB hard disk provides sufficient capacity for saving and storing user data.

TRIUMPH BOARD MINI PC6A / 7A is an ideal addition to TRIUMPH CLOUD, MyScript Stylus, RM Easiteach Next generation and Display Note software bundle which are delivered together with the TRIUMPH BOARD LED LCD.

* only TRIUMPH BOARD 65", 4K and 84", 4K LED LCD

2. Technical Specifications

TRIUMPH BOARD 55" MULTI Touch LED LCD

EAN:	8592580111891
Screen Type:	TFT LCD/ A Standard/ LED backlight
Resolution:	1920 x1080
Refresh rate:	6 ms, 60 Hz, 1400:1
Display Area:	1209.6(H) x 680.4(V)
Outline Dimensions:	1369 x 828 x 102 mm
Package Dimensions:	1485 x 980 x 220 mm
Net / Gross weight:	48/64 kg

TRIUMPH BOARD 65" MULTI Touch LED LCD

EAN:	8592580111907
Screen Type:	TFT LCD/ A Standard/ LED backlight
Resolution:	1920 x1080
Refresh rate:	8 ms, 60 Hz, 4000:1
Display Area:	1428.48 (H) x 803.52 (V)
Outline Dimensions:	1591 x 961 x 111 mm
Package Dimensions:	1710 x 1140 x 240 mm
Net / Gross weight:	72/92 kg

TRIUMPH BOARD 65" MULTI Touch LED LCD

EAN:	8592580112027
Screen Type:	TFT LCD/ A Standard/ LED backlight
Resolution:	3840 x 2160
Refresh rate:	5 ms, 120 Hz, 1400:1
Display Area:	1428.48 (H) x 803.52 (V)
Outline Dimensions:	1591 x 961 x 106 mm
Package Dimensions:	1710 x 1140 x 240 mm
Net / Gross weight:	67/86 kg

TRIUMPH BOARD 70" MULTI Touch LED LCD

EAN:	8592580111914
Screen Type:	TFT LCD/ A Standard/ LED backlight
Resolution:	1920 x1080
Refresh rate:	4 ms, 120 Hz, 4000:1
Display Area:	1538.880 (H) x 865.620 (V)
Outline Dimensions:	1713 x 1035 x 100 mm
Package Dimensions:	1830 x 1195 x 245 mm
Net / Gross weight:	73/96 kg

TRIUMPH BOARD 84" MULTI Touch LED LCD

EAN:	8592580111853
Screen Type:	TFT LCD/ A Standard/ LED backlight
Resolution:	3840 x 2160
Refresh rate:	8 ms, 120 Hz, 1600:1
Display Area:	1860.48 (H) x 1046.52 (V)
Outline Dimensions:	2006 x 1192 x 107 mm
Package Dimensions:	2170 x 1460 x 320 mm
Net / Gross weight:	118/156 kg

TRIUMPH BOARD 84" MULTI Touch LED LCD

EAN:	8592580112140
Screen Type:	TFT LCD/ A Standard/ LED backlight
Resolution:	3840 x 2160
Refresh rate:	8 ms, 120 Hz, 1600:1
Display Area:	1860.48 (H) x 1046.52 (V)
Outline Dimensions:	2006*1192*107mm
Package Dimensions:	2170*1370*320mm
Net / Gross weight:	118/156 kg

Touch System

Sensing Type:	Infrared Transmission (multi-touch)
Response Time:	< 15ms
Response Area:	Single point, opaque objects of any diameter ≥5mm Multi-point, opaque objects of any diameter ≥8mm
Scan Frequency:	200Hz
Output Coordinates:	32767×32767
Communication Mode:	Full-speed USB
Writing Screen:	Mohs hardness of 7
PC System:	Optional mini PC6A / 7A

Inputs and Outputs

HDMI:	3 / 4 (1xHDMI 4K, 1xHDMI MHL, 2xHDMI)
CVBS:	1
R/L(CVBS):	1
Coaxial Digital Audio Output:	1
Audio IN:	3
VGA OUT:	1
VGA IN:	3
RS232	1
Touch OUT:	1
Audio Output Earphone Port	1
USB 2.0:	1

USB 3.0:	1
LAN (RJ45)	1
AC IN:	1
Power:	1

* only TRIUMPH BOARD 65", 4K and 84", 4K LED LCD

Sound System

Power Amplification:	2x10W
Sound:	Surround

Power

Power Requirements:	100 – 240 V AC 50/60 Hz
Overall Power Consumption:	< 200 - 500 W *
Standby Power Consumption:	< 0,5 W

* depends on the size

Ambient Conditions

Operation Temperature	0 – 40 °C
Operation Humidity:	10 – 90% RH
Storage Temperature:	- 20 C to 60 °C
Storage Humidity:	10 – 95% RH

TRIUMPH BOARD MINI PC6A for MULTI Touch LED LCD Series

EAN:	8592580111877
Processor:	Intel i5
Graphics:	Integrated Intel® HD Graphics
Sound Card:	Integrated High Definition Audio Stereo
Networking:	Integrated 10/100/1000 Mbps adapted
Memory:	4 GB DDRIII
Hard Drive:	500 GB SATA
WIFI:	802.11 a/b/g/n, 2x2, dual-band WiFi 2,4/5 GHz + Bluetooth 4.0
USB:	4x USB 2.0 and 2x USB 3.0
Lan Port (RJ45):	1
VGA Out:	1
Mini Display Port	1
HDMI Output	1
Audio:	Side Headphone and Mic Ports
Net / Gross Weight:	1,8 / 2 kg

TRIUMPH BOARD MINI PC7A for MULTI Touch LED LCD Series

EAN:	8592580111860
Processor:	Intel i7
Graphics:	Independent Graphics GT745M
Sound Card:	Integrated High Definition Audio Stereo
Networking:	Integrated 10/100/1000 Mbps adapted
Memory:	8 GB DDRIII
Hard Drive:	1000 GB SATA
WIFI:	802.11 a/b/g/n, 2x2, dual-band WiFi 2,4/5 GHz + Bluetooth 4.0
USB:	4x USB 2.0 and 2x USB 3.0
Lan Port (RJ45):	1
VGA Out:	1
Mini Display Port	1
HDMI Output	1
Audio:	Side Headphone and Mic Ports
Net / Gross Weight:	1,8 / 2 kg

Android System

System Version	Android 4.2.1
CPU	ARM Cortex A9 dual-core CPU
GPU	Quad-Core
RAM	1.5G
ROM	8GB

3. Safety Warning

Before using the device, please read the instructions carefully.

Placement

- Do not put the device on surfaces that are unstable, easy to tilt or which can fall.
- Do not put the device in places with direct sunlight, or near sources of heat, such as electric heaters or strong light sources.
- Do not use the device next to radiation emitting equipment.
- Do not put the device in damp places or places where it might be exposed to moisture or liquids.
- Do not insert any items inside of the device.
- Do not place heavy objects on the device.

Power Supply

- Please verify compatibility between the voltage value on back shell nameplate and the main power supply voltage value.
 - In case of thunderstorm and lightning weather, please unplug power cord and antenna plug.
 - When no one is indoors or the device will not be in use for a long time, please unplug the power cord.
- Please prevent power cord from physical or mechanical damage.
- Please use the special power cord, and do not modify or extend the power cord.
 - Please check and make sure the AC power ground wire is connected.

Screen

- When writing on screen, please do not use hard or sharp objects instead of styluses.
- When it needs cleaning, please unplug the power cord first.
- Please use a soft, dust-free, dry cloth to wipe the screen.
- Do not use water and spray cleaner to clean the device.
- Please contact the service center for internal cleaning of the device.
- Do not display image with high brightness on the screen for a long time

Range of Visibility

- The best distance between eyes of viewer and screen is 5 to 7 times of screen diagonal.
- The best viewing angle between eyes of viewer and listener and screen is within 176 degrees up and down, left and right.

Temperature

- Do not place the device near an electric radiator or heating unit.
- When moving the device from a low temperature area to a high temperature area, before connecting the device to power, please leave the device idle in the new environment for some time to allow for temperature adjustment, in order to sufficiently diffuse internal condensation prior to powering on.
- The Device's normal working temperature is 0 ~ 40°C, storage temperature is -20~60°C

Humidity

- Do not expose the machine to the rain, moisture, or places near water.
- Please make sure the indoor environment is dry and cool, the machine's normal working humidity is 10~90%, storage humidity is 10~95%.

Ventilation

- Please place the machine in ventilated places, and ensure machine's good heat dissipation.
- Please ensure ventilation spaces 10 cm on the sides and back, and 20 cm on the top of the machine.

Headphones

- Extended use of headphones at high volumes may damage hearing.. If external headphones/earbuds is needed, please turn down the machine volume in advance.

Standby

- The standby button on the front of device body will not completely shut off the device, but only places the device in standby mode.

Battery

- Please dispose of used batteries in the proper manner and recycle.
- To avoid danger, please do not let children touch the battery, and do not put battery into water.

Caution

- This product is a Level 4 product, and may cause radio interference in the living environment. In this case, the user may be required to take practical measures to mitigate the effects.

4. Preparing for Installation

Unpacking

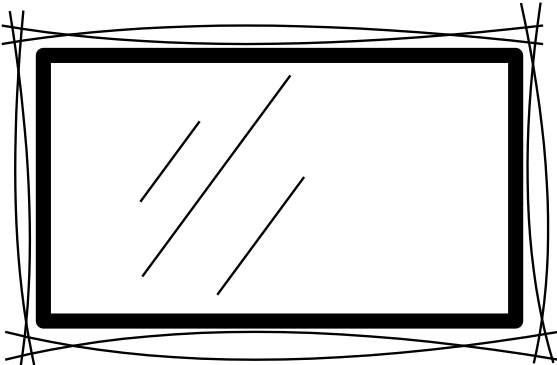

Accessories

Quick start guide, styluses, batteries, remote control, power cords (UK, US, EU), VGA cable, touch OUT USB, headphone cable, AV cable, USB Flash Drive and VC Camera Bracket.



Quick Start Guide

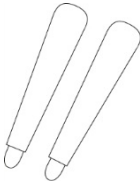

2x Stylus



Batteries

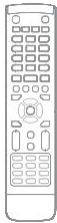

Remote control



Power Cord (US, UK, EU)



VGA Cable



USB Cable

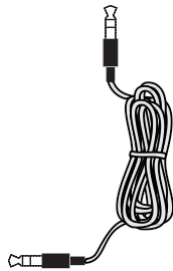

Headphone Cable



AV Cable



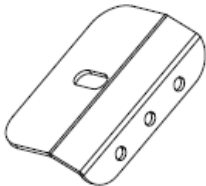

USB Flash Drive



VC Camera Bracket

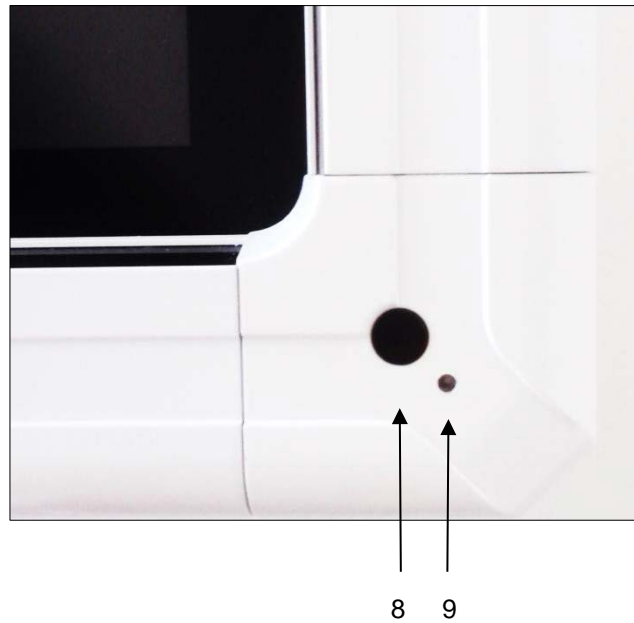
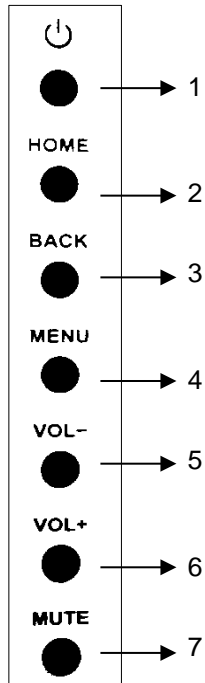

Control Panel

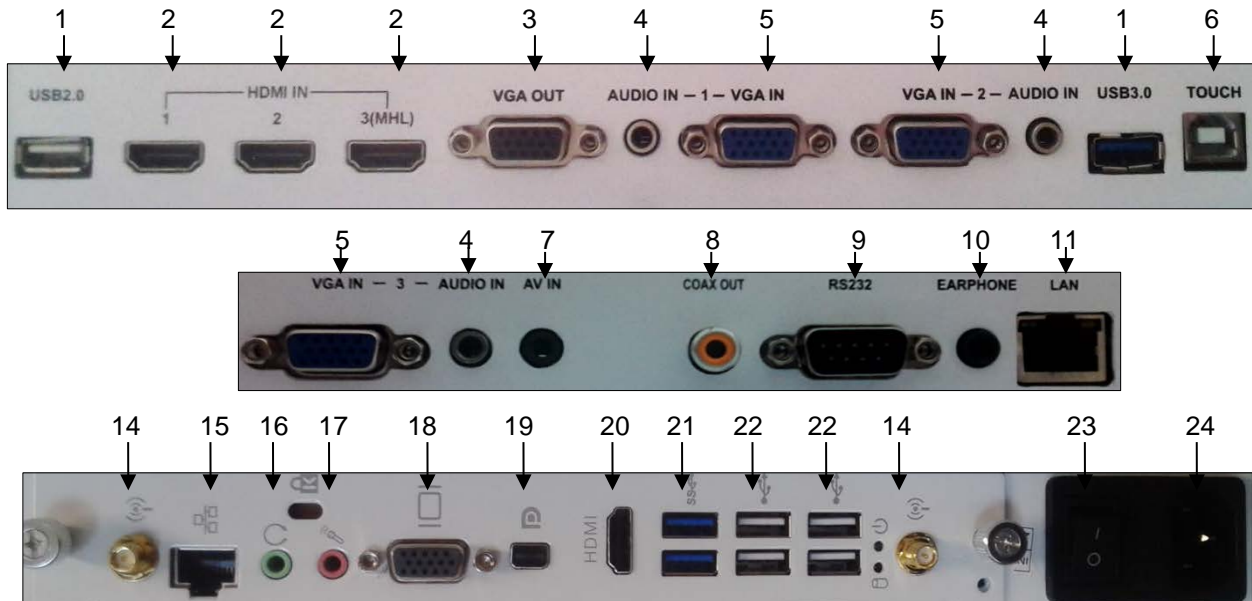

Number	Item	Function Description
1		Power on/off
2	HOME	HOME button: back to main interface
3	BACK	Return button: return to previous level menu
4	MENU	Menu button: call up function menu
5	VOL -	Volume down button: turn volume down
6	VOL +	Volume up button: turn volume up
7	MUTE	Mute button: mute volume
8	Remote control signal receiver	Receive the remote control signal. After pressing the button on the remote control LED flashes.
9	Power indicator	Indicator color shows the status of power on/off (on - green / standby mode - orange / off - off)

5. Terminal Interface



Items	Description of Function
1. USB	Connect USB devices such as mobile hard disk, USB disk, USB keyboard and mouse, USB drives, etc.
2. HDMI IN	High-definition multimedia interface signal input, for connecting to PC (personal computer) with HDMI output, set-top box, or other video device and can also implement touch function (HDMI3 can implement MHL function, HDMI4* can implement 4K/2K) * only TRIUMPH BOARD 65", 4K and 84", 4K LED LCD
3. VGA OUT	Connected to display devices with VGA input function
4. AUDIO IN	External computer audio input
5. VGA IN	External computer image input
6. TOUCH	External computer touch signal input. Default touch function is available under internal computer. When connecting an external computer, in addition to connecting external computer VGA and audio signals, the external computer's USB port needs to be connected to the equipment. Under the condition that driver is installed, the external computer can be touch controlled through the equipment (touch function is effective in PC, VGA and HDMI channel by default)
7. AV IN	Composite video and audio input
8. COAX OUT	Coaxial output
9. RS232	Serial interface, used for mutual transfer of data between devices
10. EARPHONE	Connected to device with headphone input function
11. LAN	LAN interface, connecting RJ45 terminals. (This network port is only used for Android system)
14. 	WIFI antenna interface
15. LAN (RJ45)	Network interface, connecting RJ45 port to connect to the Internet. (This network port is only used for PC)
16. EARPHONE	Connected to device with headphone input function
17. MIC	Connect to device with microphone voice collection (used for recording function)
18. VGA OUT	Connection to display device with VGA input function
19. DISPLAY PORT OUT	Connection to device with Display Port input function
20. HDMI OUT	Connection to devices with HDMI input function
21. 	USB 3.0 interface to connect USB devices, such as mobile hard disk, U disk, USB keyboard and mouse, USB drives, etc.
22. 	USB 2.0 interface to connect USB devices, such as mobile hard disk, U disk, USB keyboard and mouse, USB drives, etc.
23. POWER SWITCH	Power switch, to open and shut down AC power supply "I" is ON, "O" is OFF.
24. AC IN	AC power input, connecting AC power supply





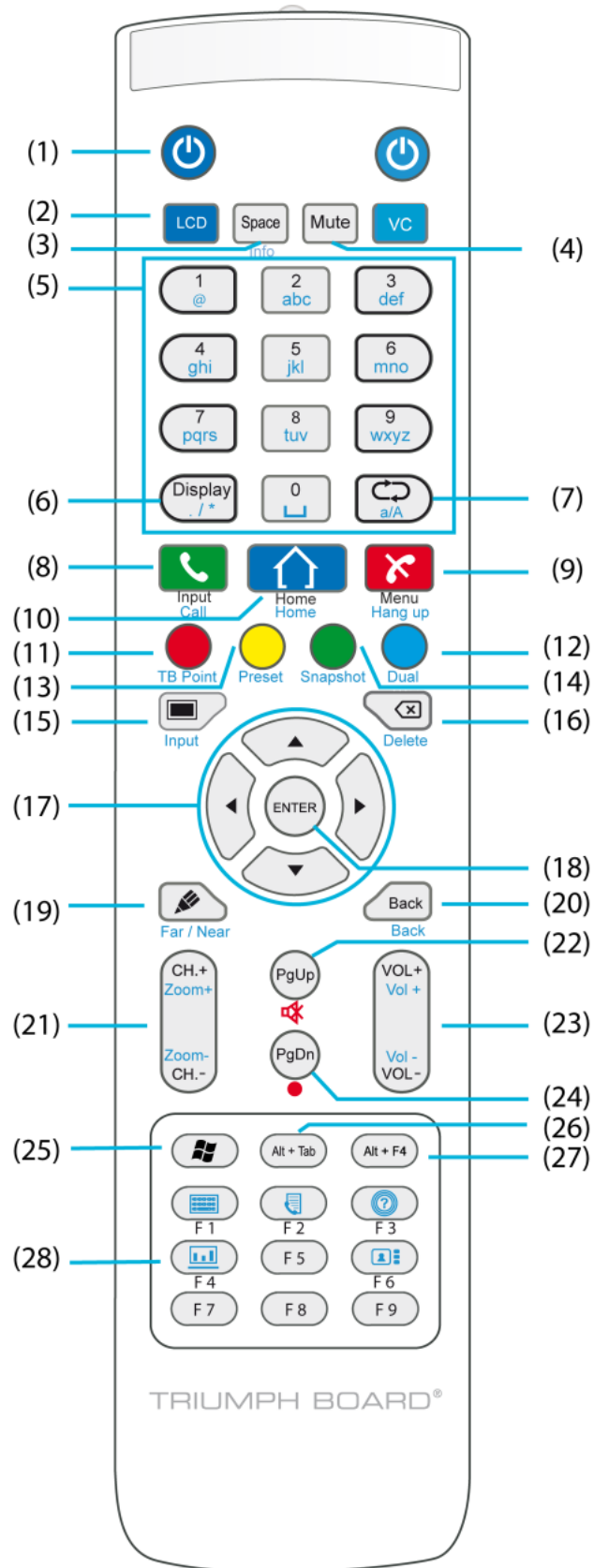

NOTE: In case of no built-in computer, interfaces 14, 15, 16, 17, 18, 19, 20, 21 and 22 are not included.

6. Remote control

Remote control button instructions



Detailed function description of remote control buttons

1. : Press this button to enter standby mode when power is on; Click this button to switch on in standby mode
2. LCD: Press this button to control your LED LCD screen.
Note: Your Remote control has been set-up automatically for the function of your LED LCD.
3. SPACE: Built-in computer Space key
4. : Mute switch
5. NUMERIC KEYS: TV digital channels input keys
6. DISPLAY: Display channel information
7. : TV channel return key
8. INPUT: Input signal source selection key, choose different sources according to need
9. MENU: TV OSD menu button, press this button to pop up TV's OSD menu
10. HOME: Android system main screen button
11. RED: TV channel function button
12. YELLOW: TV channel function button
13. GREEN: TV channel function button
14. BLUE: TV channel function button
15. : Single key for blank screen
16. : Backspace key
17. Direction keys
18. ENTER: Confirmation key, press this key to confirm mode selection
19.  Quickly start writing software (TBC Lite in Android), select writing pen quickly if software is running
20. BACK: Return key
21. CH. +, CH.-: Channel switch key
22. PG UP: Built-in computer page (previous page)
23. VOL+,VOL-: Volume switch key
24. PG DN: Built-in computer page (next page)
25. : Built-in computer Windows key
26. ALT+TAB: Built-in computer spacebar Alt + Tab
27. ALT+F4: Built-in computer program window close button
28. F1-F8: Built-in computer F1 – F9 function keys

NOTE: In case of no built-in computer, all function keys relating to the computer are regarded as having no operating functions.

Remote control use instructions

Install Batteries

- 1 Open back cover of battery compartment on the back of remote control
- 2 Install AAA type batteries according to the corresponding electrode, make sure battery positive and negative poles are correctly placed ("+" to "+", "-" to "-"), please do not mix old and new batteries
- 3 After batteries are installed, close the back cover of battery compartment, and snap the clip fastener shut against the bottom of the remote.

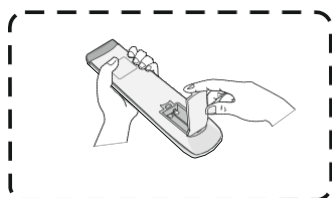

(1)

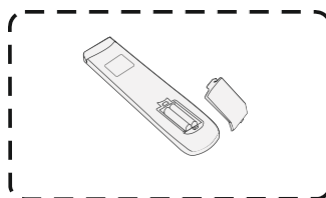

(2)

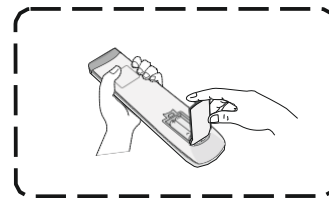

(3)

Range of remote control

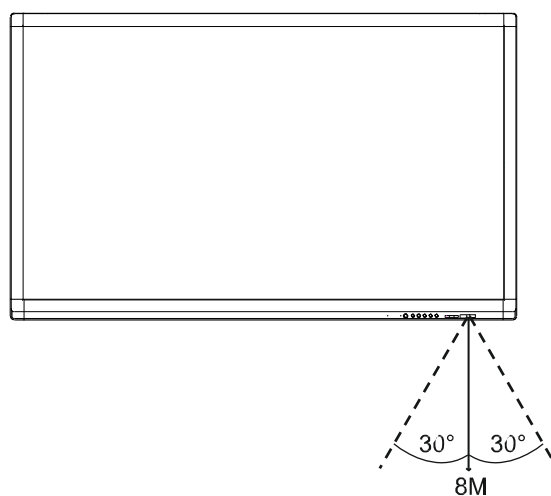

Remote control can function normally within the range of 8 meters distance, 30 degrees left and right from the remote control receiver; in order to protect the environment, please dispose of waste batteries in a designated recycling box.

CAUTION
RISK OF EXPLOSION IF BATTERY IS REPLACED WITH
AN INCORRECT TYPE
DISPOSE OF USED BATTERIES ACCORDING TO THE
INSTRUCTIONS

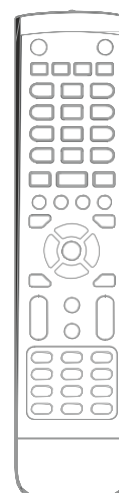

7. Connection and Setting

CAUTION

For the safety of you and the device, please do not connect any power cord before the external device has been prepared.

External Computer and Touch Connection

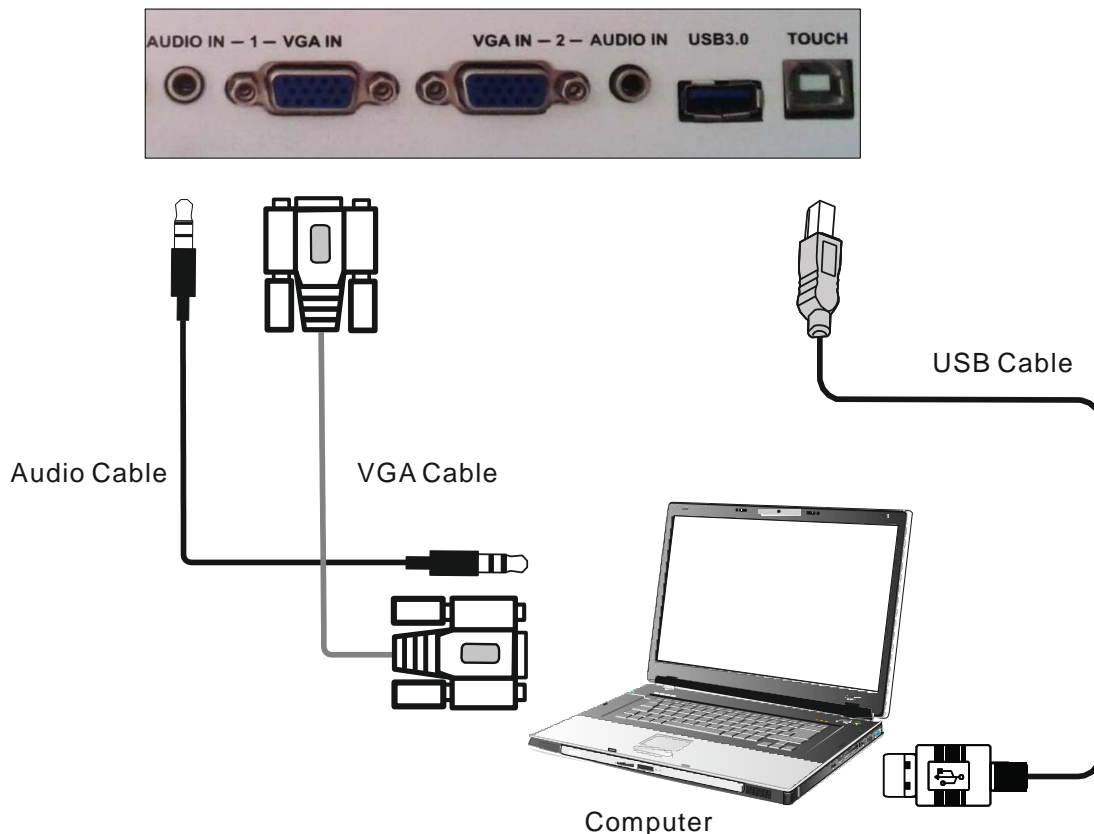

- (1) Use VGA line to connect to VGA output port of external computer, and meanwhile use headphone audio line to connect to external computer audio output interface.
- (2) Use USB line to connect to external computer USB port.
- (3) After connection is completed, plug in power cord, and switch POWER to On.
- (4) Start external computer.
- (5) Press \downarrow key, and the equipment is powered on.
- (6) Press the INPUT key to switch to VGA channel.

NOTE:

External computer input, equipment's best resolution is 1920x1080.

External computer can also connect to the equipment through the HDMI cable

- Recommended computer configuration:

2.0GBHZ Processor, 1GB Memory More than 256 color display card
1GB Available Hard Drive Support Resolution 800*600, 1024*768
VGA-OUT/HDMI-OUT, Audio-OUT, USB Interface

Audio and video equipment

AV

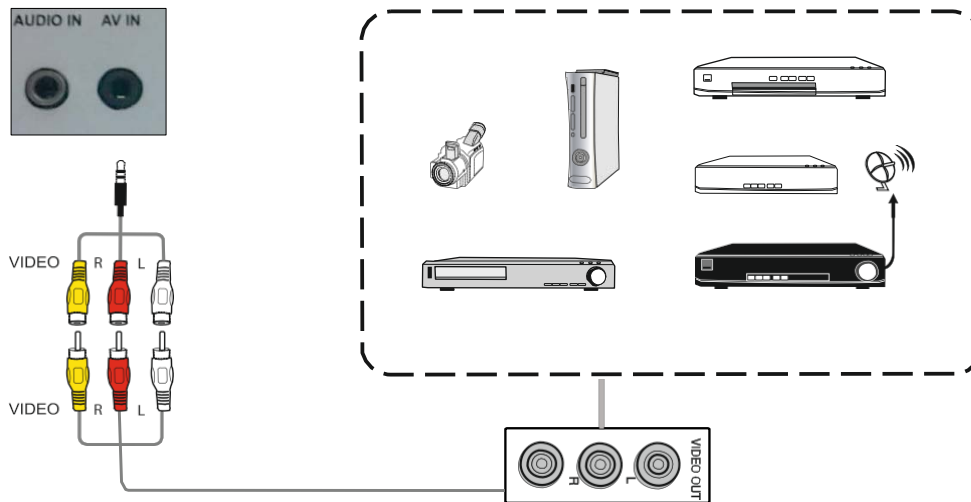

- (1) Use AV audio and video lines to connect audio and video equipment with AV output (yellow for video, red for right sound channel, and white for left sound channel)
- (2) After line connection, plug in power cord, and switch power to On
- (3) Press  to turn equipment on
- (4) Press INPUT key to switch to CVBS port

HDMI1 / HDMI2 / HDMI3 (MHL) / HDMI4 (4K2K)* * only TRIUMPH BOARD 65", 4K and 84", 4K LED LCD

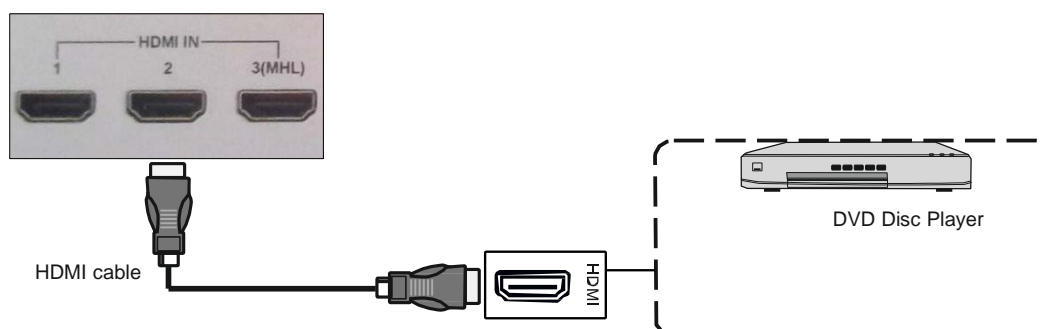

- (1).Use HDMI line to connect audio and video equipment with HDMI output
- (2).After line connection, plug in power cord, and switch power On
- (3) Press  to turn equipment on
- (4).Press INPUT key to switch to HDMI port (HDMI3 channel can perform the MHL function, HDMI4 channel can be used for 4K*2K)

Coaxial connection

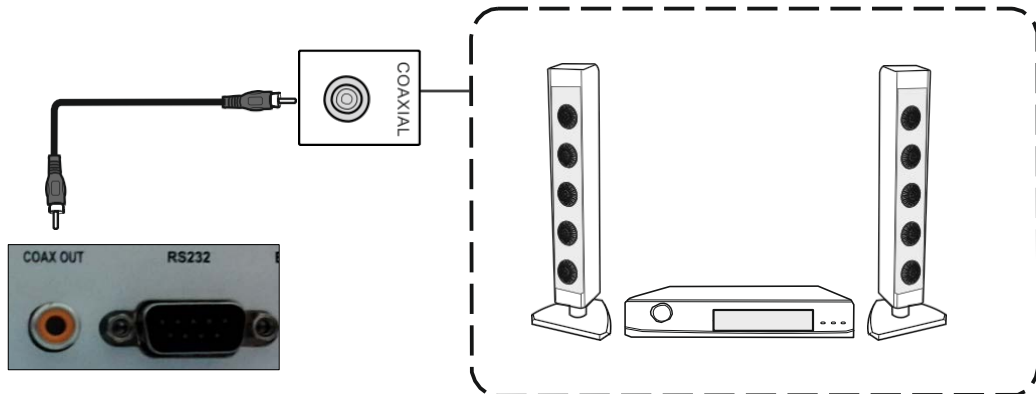

- (1). Use coaxial line to connect audio device with coaxial input
- (2). After line connection, plug in power cord, and switch power to On
- (3). Press  to turn equipment on

Video output connection

VGA output connection

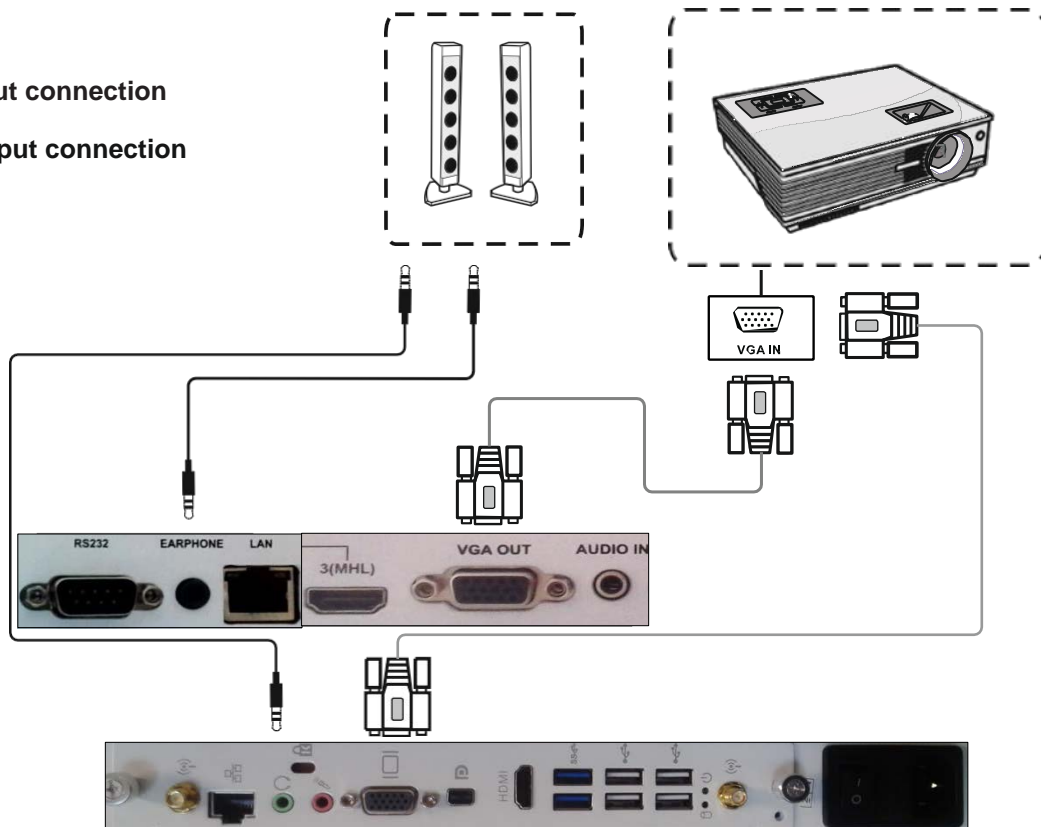

Computer

- (1). Use VGA line to connect display devices with VGA input, and use headphone line to connect sound output
- (2). After line connection, plug in power cord, and switch power to On
- (3). Press  to turn equipment on
- (4). Press INPUT key to switch to PC port
- (5). Set internal computer as VGA output or multi-screen display TV

Note: VGA OUT of TV outputs VGA IN graphics and sound

USB Equipment connection

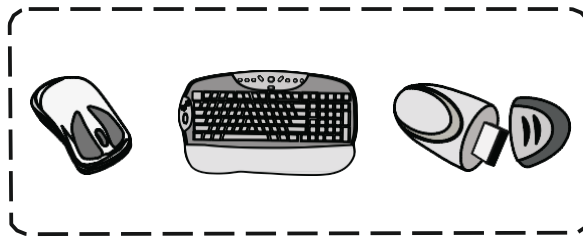

Network cable connection

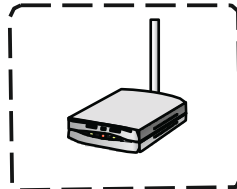

Microphone connection

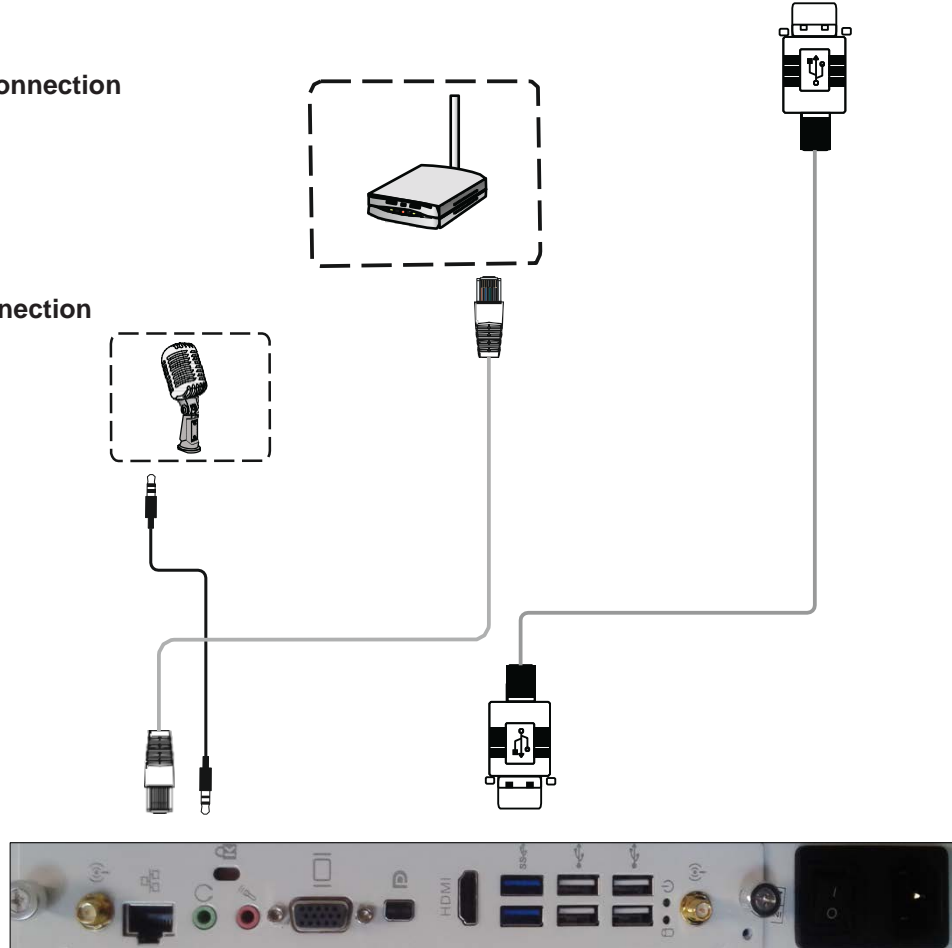

WAN connection

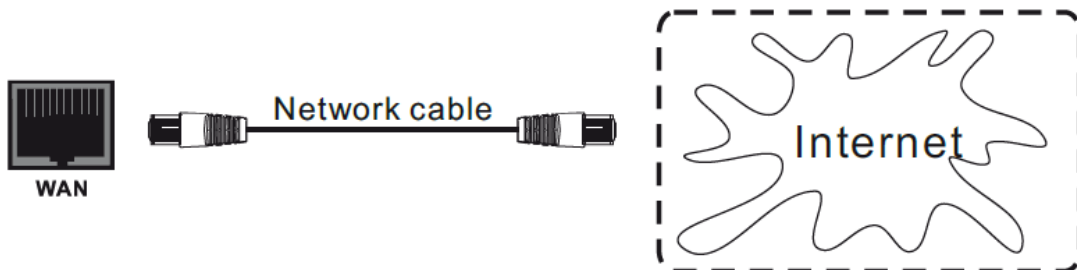

NOTE: If the user wants the built-in computer and android system to connect to the Internet at the same time, Connect item 6 and item 8 at the same time.

USB equipment connection

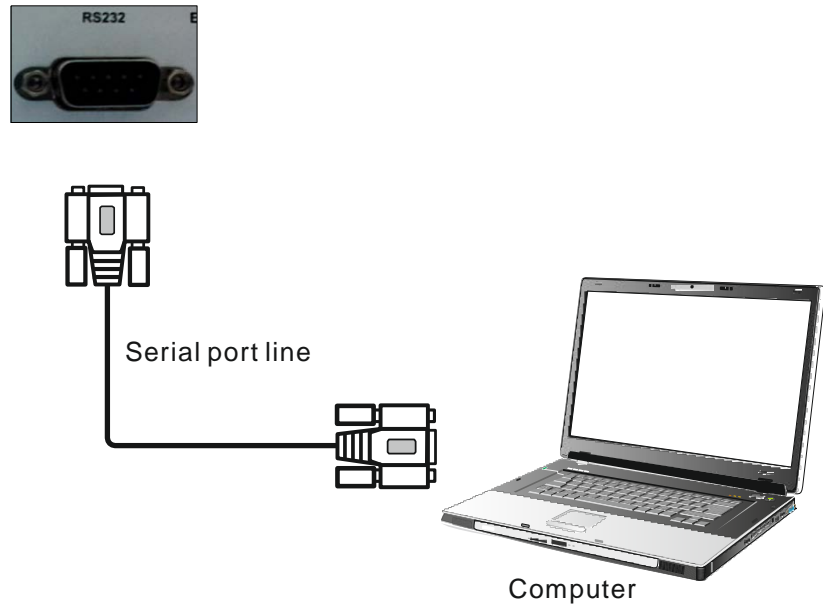

After using the serial port line to connect central control equipment and the device, certain functions of the device can be controlled via the central control device, such as: device ON/OFF, and adjustment of sound volume, etc.

PC part basic operations:

1. If the TV is on and the computer is not started, press INPUT key to switch from channels other than PC to the PC channel, then turn on the computer.
2. When it is on, hold down POWER key for 2 seconds, click to select "Confirm" in the pop-up reminder menu to shut down the TV and computer simultaneously.
3. Under the PC channel when it is on, touch to select "WINDOWS" button on the lower left of the desktop or press "WINDOWS" key on remote control, and then select "power off" item, to turn off computer without turning off TV.

8. Menu Operation

One Touch menu operation

Call up method

Take middle point position on the bottom of display screen as the starting point, use finger or stylus to drag towards screen center position to call up touch menu, as shown below.

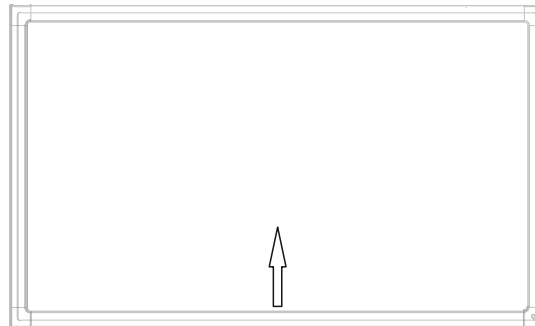

Settings menu

Input setting



- Press INPUT button on remote control or via above "A" touch method to call up Settings Input menu;
- Press ▼/▲/◀/▶ button on remote control to select the channel you need;
- Press the Enter button on remote control, or click directly to confirm selected input channel;
- Press return key on remote control, or click blank area outside menu to exit menu.

Note: PC channel will only display when you connect the built-in computer.

HDMI 4K channel will only display in the panels that support the 4K2K function (only TRIUMPH BOARD 65", 4K and 84", 4K LED LCD).

Brightness setting

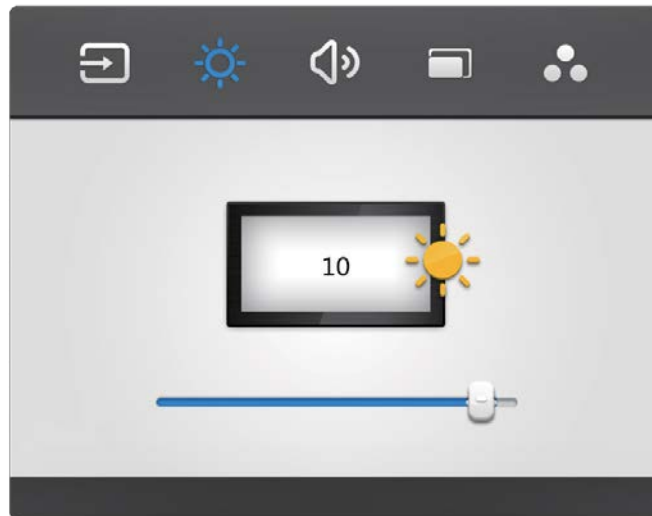

- Press INPUT button on remote control or via touch A method to call up Input Setting menu;
- Press ► button on remote control or click “☀️” icon to enter Brightness setting menu;
- Press ◀️/▶️ button on remote control or drag brightness adjustment progress bar to adjust brightness;
- Press return key on remote control, or click blank area outside menu to exit menu.







Volume setting

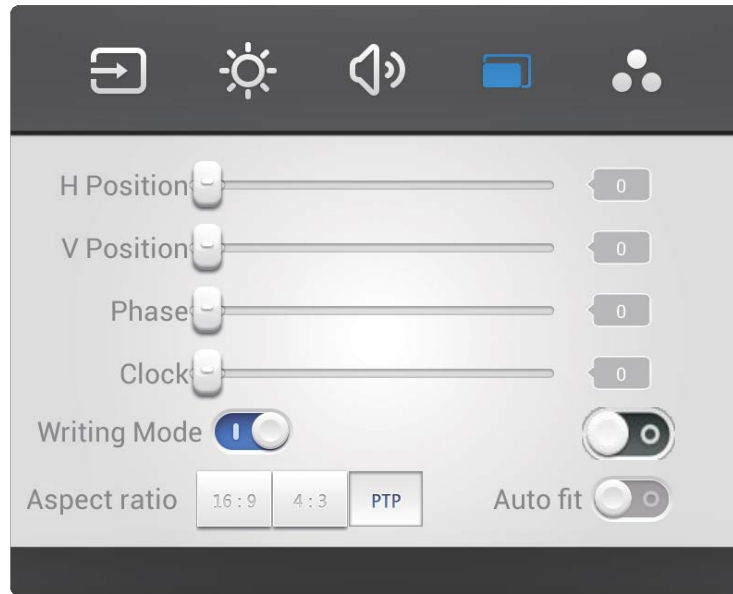

- Press INPUT button on remote control or use touch method A to call up the Input Setting menu;
- Press ► button on remote control or click “🔊” icon directly to enter Volume Setting menu;
- Press ◀️/▶️ button on remote control or drag volume adjustment progress bar to adjust volume;
- Press ◀️➡️ button on remote control or click mute icon below “🔊” to open or close mute state;
- Press return key on remote control, or click blank area outside menu to exit menu.

Zoom setting



- Press INPUT button on remote control or via touch use method A to call up the Settings menu;
- Press  button on remote control under Settings menu or click "" icon with touch pen to enter the Settings menu;
- Press /// button on remote control or click directly to select and adjust each option;
- Press return key on remote control, or click blank area outside menu with touch pen to exit menu.

H position

Press / button on remote control or directly drag icon with touch pen to adjust horizontal position of image;



V Position

Press / button on remote control or directly drag icon with touch pen to adjust vertical position of image;



Phase

Press / button on remote control or directly drag icon with touch pen to adjust phase position of image;

Clock

Press / button on remote control or directly drag icon with touch pen to adjust image clock;

Writing Mode

Press / button to on/off the writing mode. (This icon only display in PC and HDMI4K channels).

3D

Press Enter button on remote control or click directly icon with touch pen to switch on/off 3D function. (This icon only display in the panels in PC and HDMI4 channels which support 3D function.)

Aspect ratio





Press / button on remote control or press Enter button or click icon directly with touch pen to switch image display ratio;

Auto fit

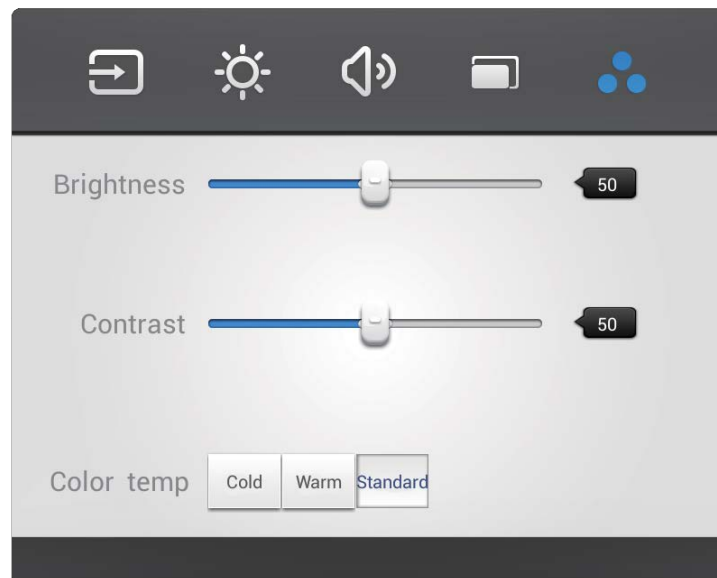
Press Enter button on remote control or click icon directly with touch pen to automatically adjust horizontal, vertical position/phase and clock of image.

Screen setting





- Under channels other than Android, press Menu button on remote control or via touch A method to call up settings menu;
- Press  button on remote control or click “” icon directly. Press Menu on remote control to enter advanced settings menu;
- Press // button on remote control or click directly with touch pen to select and adjust each option;
- Press return key on remote control, or click blank area outside menu with touch pen to exit menu.



Brightness

Press / button on remote control or drag icon directly with touch pen to adjust brightness of image.

Contrast

Press / button on remote control or drag icon directly with touch pen to adjust contrast of image.

Color temp

Press / button on remote control or drag icon directly with touch pen to adjust color temperature of image (Cool color / Warm color / Automatic).

Note: Different options in different channels can't be adjusted, please select according to actual situation.

9. More Settings (Advanced settings)

Advanced settings menu

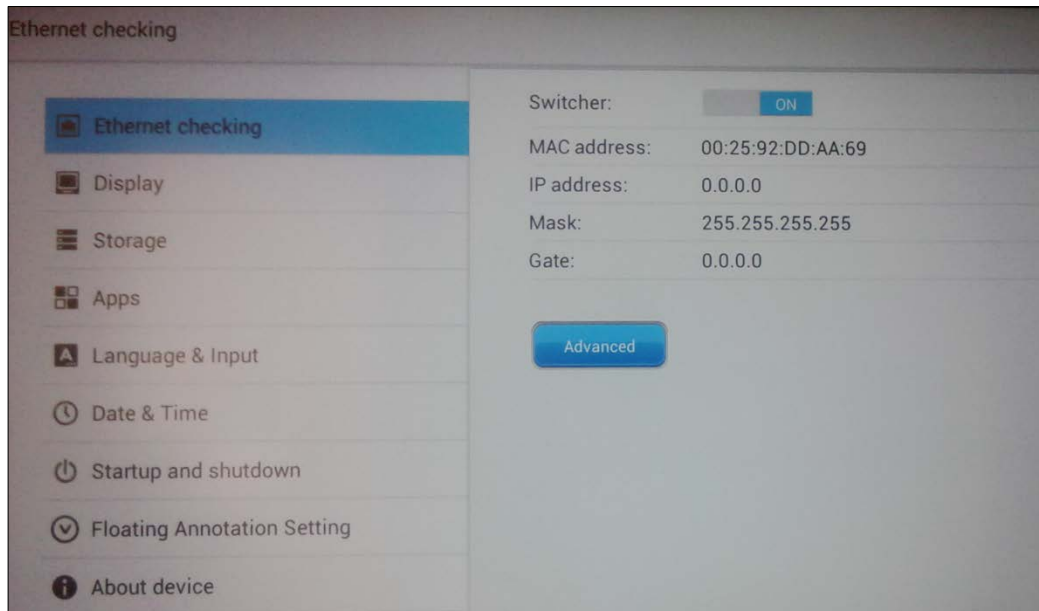

- Under Apps menu, click on Settings call up Advanced settings menu;
- Press ▼/▲/◀/▶ button on remote control or click directly to select each option;
- Press return key on remote control or front panel of equipment to exit menu.

Ethernet Checking

View the current network connection status and the network parameters of the device.

Display

Adjust equipment display brightness/system wallpaper and system font size.

Storage

View the system storage information.

Apps

Display each application in Android system memory.

Language & Input

Adjust display language and input method settings of Android system.

Date & Time

Under Android system, set system time and format (time can be automatically obtained or manually set).

Startup and Shutdown

Adjust Launch setting and Timer switch

Floating Annotation Setting

Adjust Annotation menu







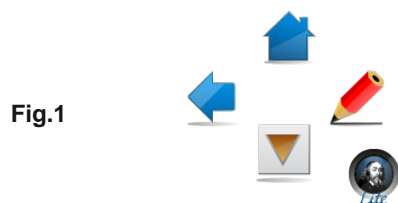

About Device

Display Android system software version information.

Annotation menu



- Place two fingers on the screen (about 20~50mm apart) and keep in position more than two seconds under any channel to call up annotation menu (Figure 1);
- In annotation, menu is shown in Figure 2.
- In annotation, input only using your fingers; stylus and remote control cannot perform annotation.

	Annotation menu icon	Pop up sub-menu
	Return icon	Click to return to previous operation interface
	Main interface icon	Click to return to main interface of Android system
	Annotation brush icon	Click to make annotation in the picture, click again to change brush color
	TB Comenius Lite	Click to enter TB Comenius Lite software. Screen image will be saved automatically when you close TB Comenius Lite software. Storage location: resource browse/blackboard writing
	Resource browse icon	Click to open resources browse menu
	Screenshot icon	Click for screenshot of current annotation image Screenshot storage location: resource browse/blackboard writing
	Close icon	Click to close annotation menu

10. Android System Interface

Main Interface



- Switch to Android channel to display main interface as shown above;
- Press ◀/▶ key on remote control to select icon below, and press Enter key to enter corresponding program, or click on the associated icon directly to enter the program;
- In any program, press Home button on the remote control or <Home key> on the front frame of the device to return to the main interface.

TB Finder	Enter android system resource browser, see page 28
Browser	Enter internet page, see page 29
PIP	Enter picture-in-picture image, see page 30
Settings	Enter settings menu page, see page 22
Apps	Enter settings menu page, see page 31

TB Finder

Display files in Android system memory and Android system external storage.



- | | |
|----------------------------------|--|
| 1. Storage device display | Click with touch pen to enter corresponding storage devices area |
| 2. Menu/exit menu | Click menu icon with touch pen to pop up menu options {order (type/size/time)}
Click exit icon with touch pen to directly exit resource browse. |
| 3. File type menu | Documents: OFFICE type files

Blackboard writing: images stored by TBC Office Lite and images stored by annotation screenshots
Video: audio and video type files
Image: image type files
Music: audio type files
All: files of all types |
| 4. File operation menu | Can perform basic operations towards file such as select/delete/create/copy/cut |
| 5. File arrangement menu | Divided into two arrangement modes by icon and by list |
| 6. Main display area | Display files of corresponding to type on memory card |

Browser

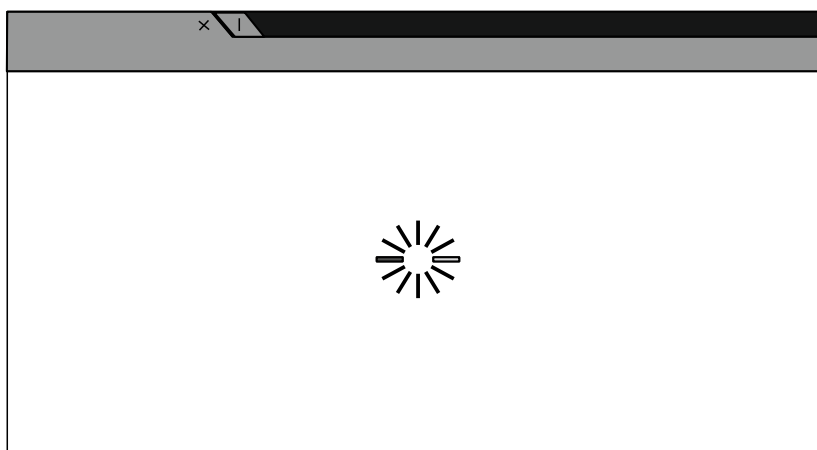

- In the connected network state, enter web browsing for surfing the internet, click on "x" symbol in the upper left corner to close it.

PIP

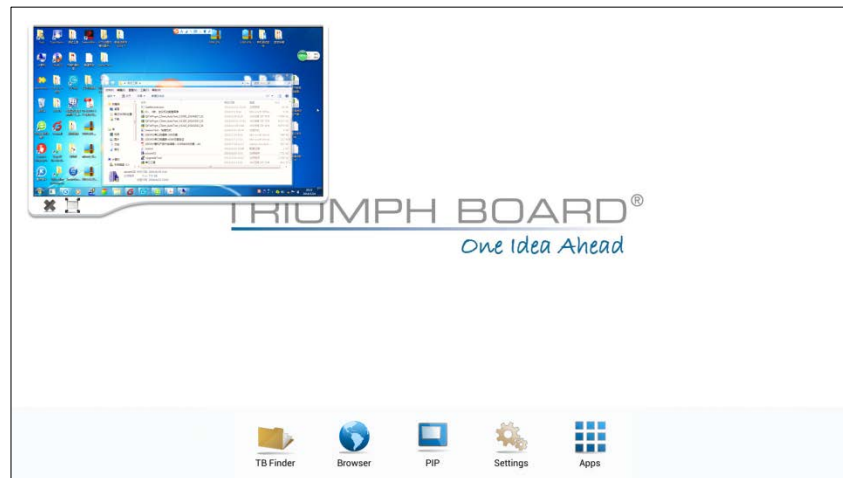

- Enter channel browse to pop up picture-in-picture interface in displayed image;
- Press ▲ button on remote control or click directly picture-in-picture display interface point, to pop up channel selection list of picture-in-picture, press ► button on remote control to move selection cursor into channel list, then press ▼/▲ button to select corresponding channels. When selection cursor reaches the channel you need, press Enter key to play image and sound of related channel on interface, or click directly the channel you need to enter;
- Picture-in-picture interface operation key is shown above.



Click picture-in-picture channel for full screen



Click to exit picture-in-picture interface

Settings

- Shortcut Settings in settings menu, see page 26.

Apps



Caution!





Please note that you cannot install your own applications into Apps section!



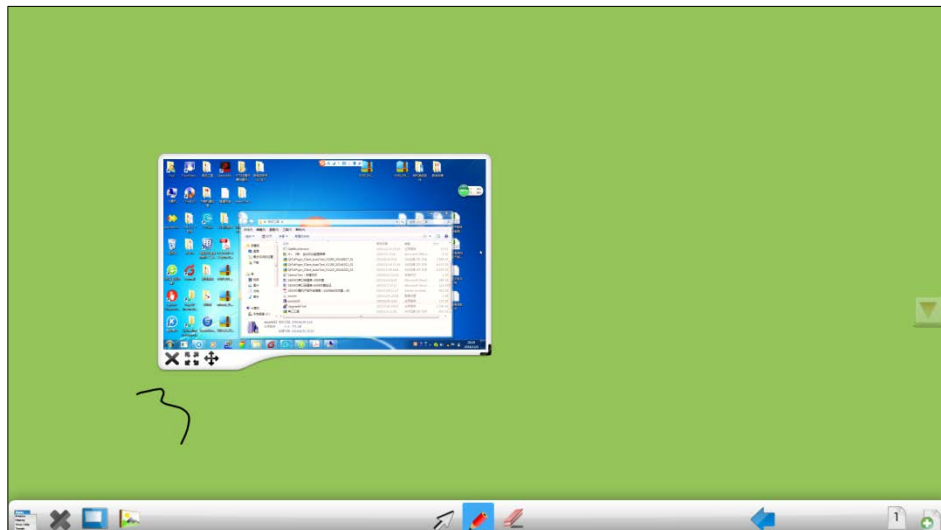



Each application must be suitable for screen resolution and hardware specifications, as some apps may have display or performance problems!

Browser	See page 29
Settings	See page 22
TB Comenius Lite	See page 31

TB Comenius Lite











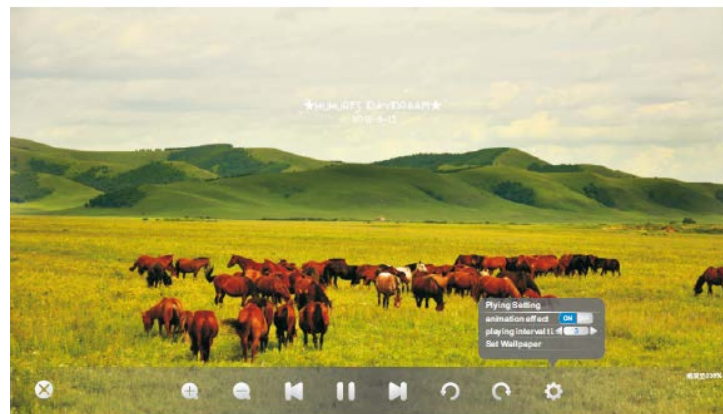

	Menu icon	Click to pop up sub-menu (change background/save)
	Exit icon	Click to exit TB Comenius Lite software
	Picture in picture Image import icon	Click to pop up picture in picture interface, see page 30 Click to import required image from memory card
	Select icon	Click to select Whiteboard writing symbols,

		can click or check to select
	Brush icon	Click to write, press long for three seconds to enter setting screen, to set brush color and thickness
	Eraser icon	Click to erase writing symbols, can be erased by box selection
	Undo icon	Click to cancel previous step
	Redo icon	Click to restore previous step
	Page icon	Display writing page number displayed by current picture
	Add page icon	Click to add a new page of writing or image

11. Multimedia File Playback Interface

Image play



-  Close current picture
-  Magnify current picture
-  Reduce current picture
-  Display previous picture
-  Play/pause
-  Play next picture
-  Counterclockwise rotate current picture displayed
-  Clockwise rotate current picture displayed
-  Play setting {Animation effect (on/off)/Slide time interval/Set as wallpaper}

Audio play



- ⊗ Close current audio file
- ⏮ Play previous audio
- ⏪ Play/pause file
- ⏩ Play next audio file
- ☰ Playlist
- ⏴ Loop play
- ⏵ Random play
- ⏶ Single play

Video play



- ⊗ Close current video file playing
- ⏮ Play previous video
- ⏮ File Fast backward
- ⏪ Play/pause
- ⏩ Fast Forward
- ⏩ Play next audio file
- ☰ Playlist

12. VC Camera Bracket installation

Note: You need to have TRIUMPH BOARD Videoconferencing System before you start. VC system is not included in the accessories

Please install the bracket on LED LCD when you unpack the unit, before wall mounting.

1. Attach the bracket at the bottom part of the camera, using the 1/4-20, 6mm screw you find with the bracket in the LED LCD unit accessories.



2. Unscrew top three screws in the top center of the back cover of the LED LCD unit

3. Attach the camera with the bracket using three screws in the top center of the back cover of the LED LCD unit



4. Finally, plug the camera cable from your TRIUMPH BOARD Videoconferencing System.

13. Troubleshooting

Board fails to work normally

Remote control failure	<ol style="list-style-type: none"> 1. Check whether there are other objects between remote control and television remote control receiving window, blocking signal transmission and thus leading to failure of remote control. 2. Check whether the battery terminal in the remote control is correctly connected. 3. Check whether remote control needs battery replacement.
Device automatically shuts down	<ol style="list-style-type: none"> 1. Check whether the sleep function is set or not. 2. Check whether there has been a sudden power outage. 3. Check whether there is no signal automatic shutdown.

PC mode

Signal out of range	<ol style="list-style-type: none"> 1. Check whether display is set correctly. 2. Check whether resolution is the best resolution. 3. Adjust line and field synchronization in menu.
Background has vertical lines or streaks	<ol style="list-style-type: none"> 1. Select automatic correction in menu. 2. Adjust clock and phase position in menu.
Image lack of color, color is incorrect	<ol style="list-style-type: none"> 1. Check whether VGA is not securely connected or has a quality problem. 2. Adjust color and brightness or contrast in menu.
Display format that is not supported	<ol style="list-style-type: none"> 1. Select automatic correction in menu. 2. Adjust clock and phase position in menu.

Touch Function

Touch function invalid	<ol style="list-style-type: none"> 1. Check whether touch driver is installed and started. 2. Check whether the size of article touched is comparable with finger.
Touch positioning not correct	<ol style="list-style-type: none"> 1. Check whether driver is properly installed and make correction. 2. Check whether touch using finger or stylus is facing the screen.

Video Malfunctions

No picture and no sound	<ol style="list-style-type: none"> 1. Check whether the device is in active mode. 2. Check whether the signal wire is plugged in securely, using the corresponding INPUT. 3. If in internal computer mode, check whether internal computer is running.
With horizontal or vertical stripes or image distortion	<ol style="list-style-type: none"> 1. Check whether signal wire is securely connected. 2. Check whether other electronic equipment or power tools are placed around the device.
No color, color is weak or image is weak	<ol style="list-style-type: none"> 1. Adjust color and brightness or contrast in menu. 2. Check whether signal wire is securely connected.

Audio Malfunctions

Image but no sound	<ol style="list-style-type: none"> 1. Check whether mute button is pressed for mute. 2. Press VOL. + / - to adjust volume. 3. Check whether audio line is connected correctly.
Only one speaker has sound	<ol style="list-style-type: none"> 1. Adjust sound balance in menu. 2. Check whether computer sound control panel only sets up one sound channel. 3. Check whether audio line is connected correctly.
VGA output without sound	<ol style="list-style-type: none"> 1. Check whether an external device is connected with headphone cable.

14. Software protocols

This document describes the hardware interface specification and software protocols of RS232 interface communication between LED LCD and PC or other control unit with RS232 protocol.

14.1 Description

Hardware specification

LED LCD communication port is on the rear bottom side

(1) Connector type: DSUB 9 Pin Male

(2) Pin Assignment

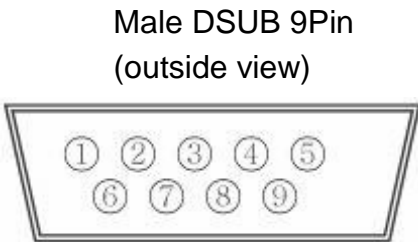

Pin #	Signal	Remark
1	NC	
2	TXD	Output to TV
3	RXD	Input from TV
4	NC	
5	GND	
6	NC	
7	NC	
8	NC	
9	NC	
frame	GND	



- Pin2 is TXD, Pin3 is RXD. Pin to Pin connection as below.

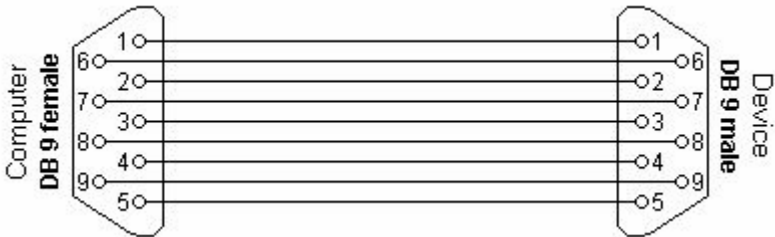

Serial port communication setting:

- ◆ Baud Rate Select: 9600bps (fixed)
- ◆ Data bits: 8bits (fixed)
- ◆ Parity: None (fixed)
- ◆ Stop Bits: 1(fixed)

Protocols

- ◆ Command Format

No.	Content	Description	Remar
1	0xAA	Head	fixed value
2	0xBB		fixed value
3	0xCC		fixed value
4		Main command	
5		subcommand	
6	0x00	Length	valid data
7	checksum	checksum	Sum from No.4 to No.6.
8	0xDD	End	fixed value
9	0xEE		fixed value
10	0xFF		fixed value

IR Code list

Function	Mode	Code	Note
Power	ON	AA BB CC 01 00 00 01 DD EE FF	
	OFF	AA BB CC 01 01 00 02 DD EE FF	
Channels	TV	AA BB CC 02 01 00 03 DD EE FF	
	CVBS	AA BB CC 02 02 00 04 DD EE FF	
	VGA3	AA BB CC 02 0B 00 0D DD EE FF	
	VGA1	AA BB CC 02 03 00 05 DD EE FF	
	VGA2	AA BB CC 02 04 00 06 DD EE FF	
	HDMI1	AA BB CC 02 06 00 08 DD EE FF	
	HDMI2	AA BB CC 02 07 00 09 DD EE FF	
	HDMI3	AA BB CC 02 05 00 07 DD EE FF	
	PC	AA BB CC 02 08 00 0A DD EE FF	
	Android	AA BB CC 02 0A 00 0C DD EE FF	
Volume	000—100	AA BB CC 03 00 xx ** DD EE FF	
	MUTE	AA BB CC 03 01 00 04 DD EE FF	
	UNMUTE	AA BB CC 03 01 01 05 DD EE FF	
Aspect	16:9	AA BB CC 08 00 00 08 DD EE FF	
	4:3	AA BB CC 08 01 00 09 DD EE FF	

	Point to point	AA BB CC 08 07 00 0F DD EE FF	
TV channels	ATV 00-99	AA BB CC 05 00 XX ** DD EE FF	
Power of PC	ON	AA BB CC 09 01 00 0A DD EE FF	OK
	OFF	AA BB CC 09 00 00 09 DD EE FF	OK
Function	Mode	Code	Note
Function of Remote Control	WIN	AA BB CC 07 0B 00 12 DD EE FF	
	Space	AA BB CC 07 46 00 4D DD EE FF	
	Alt+Tab	AA BB CC 07 1D 00 24 DD EE FF	
	Alt+F4	AA BB CC 07 1F 00 26 DD EE FF	
	NUM_1	AA BB CC 07 00 00 07 DD EE FF	
	NUM_2	AA BB CC 07 10 00 17 DD EE FF	
	NUM_3	AA BB CC 07 11 00 18 DD EE FF	
	NUM_4	AA BB CC 07 13 00 1A DD EE FF	
	NUM_5	AA BB CC 07 14 00 1B DD EE FF	
	NUM_6	AA BB CC 07 15 00 1C DD EE FF	
	NUM_7	AA BB CC 07 17 00 1E DD EE FF	
	NUM_8	AA BB CC 07 18 00 1F DD EE FF	
	NUM_9	AA BB CC 07 19 00 20 DD EE FF	
	NUM_0	AA BB CC 07 1B 00 22 DD EE FF	
Display	AA BB CC 07 1C 00 23 DD EE FF		

Refresh	AA BB CC 07 4C 00 53 DD EE FF		
Input	AA BB CC 07 07 00 0E DD EE FF		
Home	AA BB CC 07 48 00 4F DD EE FF		
Menu	AA BB CC 07 0D 00 14 DD EE FF		
Delete	AA BB CC 07 40 00 47 DD EE FF		
Energy	AA BB CC 07 4E 00 55 DD EE FF		
UP	AA BB CC 07 47 00 4E DD EE FF		
DOWN	AA BB CC 07 4D 00 54 DD EE FF		
LEFT	AA BB CC 07 49 00 50 DD EE FF		
RIGHT	AA BB CC 07 4B 00 52 DD EE FF		
ENTER	AA BB CC 07 4A 00 51 DD EE FF		
Point	AA BB CC 07 06 00 0D DD EE FF		
Back	AA BB CC 07 0A 00 11 DD EE FF		
CH+	AA BB CC 07 02 00 09 DD EE FF		
CH-	AA BB CC 07 09 00 10 DD EE FF		
VOL+	AA BB CC 07 03 00 0A DD EE FF		
VOL-	AA BB CC 07 41 00 48 DD EE FF		
PageUp	AA BB CC 07 42 00 49 DD EE FF		
PageDown	AA BB CC 07 0F 00 16 DD EE FF		
F1	AA BB CC 07 45 00 4C DD EE FF		
F2	AA BB CC 07 12 00 19 DD EE FF		
F3	AA BB CC 07 51 00 58 DD EE FF		
F4	AA BB CC 07 5B 00 62 DD EE FF		
F5	AA BB CC 07 44 00 4B DD EE FF		
F6	AA BB CC 07 50 00 57 DD EE FF		
F7	AA BB CC 07 43 00 4A DD EE FF		
F8	AA BB CC 07 1A 00 21 DD EE FF		
F9	AA BB CC 07 04 00 0B DD EE FF		
F10	AA BB CC 07 59 00 60 DD EE FF		
F11	AA BB CC 07 57 00 5E DD EE FF		
F12	AA BB CC 07 08 00 0F DD EE FF		
RED	AA BB CC 07 5C 00 63 DD EE FF		
GREEN	AA BB CC 07 5D 00 64 DD EE FF	\	
YELLOW	AA BB CC 07 5E 00 65 DD EE FF	\	
BLUE	AA BB CC 07 5F 00 66 DD EE FF	\	
Function	Mode	Code	Note

Status Check Codes:

Function	Search Code	Reply Code	Status	Example
Check Power Status	AABBCC0102 0003DDEEFF	AA BB CC 80 00 00 80 DD EE FF	ON	
		AA BB CC 80 01 00 81 DD EE FF	OFF	
Check volume	AABBCC0302 0005DDEEFF	AA BB CC 82 00 xx ** DD EE FF	Volume is xx	xx=the amount of volume. EX.
				The volume is 30(decimal)=1E (Hexadecimal), xx=1E, **=03+00+1E(Hexadecimal)=21
Check audio status	AABBCC0303 0006DDEEFF	AA BB CC 82 01 00 83 DD EE FF	MUTE	
		AA BB CC 82 01 01 84 DD EE FF	UNMUTE	
Check input status	AABBCC0200 0002DDEEFF	AA BB CC 81 01 00 82 DD EE FF	TV	
		AA BB CC 81 02 00 83 DD EE FF	AV	
		AA BB CC 81 03 00 84 DD EE FF	VGA1	
		AA BB CC 81 04 00 85 DD EE FF	VGA2	
		AA BB CC 81 05 00 86 DD EE FF	HDMI3	
		AA BB CC 81 06 00 87 DD EE FF	HDMI1	
		AA BB CC 81 07 00 88 DD EE FF	HDMI2	
		AA BB CC 81 08 00 89 DD EE FF	PC	
		AA BB CC 81 0A 00 8B DD EE FF	ANDROID	
		AA BB CC 81 0D 00 8E DD EE FF	HDMI (4k*2K	
		AA BB CC 81 0C 00 8D DD EE FF	WHDI	
		AA BB CC 81 0B 00 8C DD EE FF	VGA3	
Check PC status	AABBCC0902 000BDDEEFF	AA BB CC 83 00 00 83 DD EE FF	ON	
		AA BB CC 83 01 00 84 DD EE FF	OFF	
		AA BB CC 83 02 00 85 DD EE FF	SLEEP	
		AA BB CC 83 03 00 86 DD EE FF	Hibernate	

15. Maintenance

Proper maintenance can prevent many early defects; regular, careful cleaning can keep the device like brand new.

Please unplug power plug before cleaning and maintenance, to prevent electric shock.

Clean screen

Mix a small amount of fabric softener or dishwashing detergent with warm water. Dip a soft cloth into the mixture, and then wring to a semi-dry state. Use this to wipe the screen of the device. Repeat several times, being careful not to squeeze any liquid into the device when wiping the device.

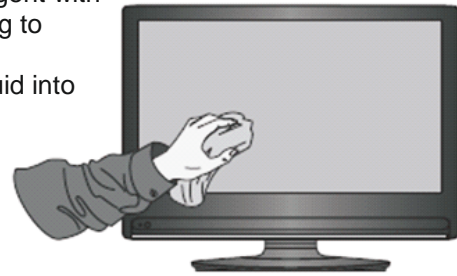

Clean front frame

Please use dry, soft, lint-free cloth to wipe front frame.

Device to remain unused for extended period

If the device will not be used for an extended period of time, such as vacation, please make sure to unplug the cord to prevent any possible dangers caused by power surges from lightning.

16. Display mode

1. VGA mode

Resolution / Display mode	Field frequency (Hz)
640x480	60
800x600	
1024x768	60
1280x800	
1920x1080	50
	60

2. HDMI mode

Resolution / Display mode	Field frequency (Hz)
480p	60
480i	
576p	50
576i	
720p	50
	60
1080i	50
	60
1080p	50
	60
2160p	30

17. Repair Service and Contacts

Please contact your local supplier regarding warranty and technical service or find all warranty conditions and service partners on our website www.triumphboard.com. If you have any questions please email us at info@triumphboard.com

TRIUMPH BOARD a.s.

Neklanova 122/15

128 00 Prague 2

Czech Republic

EU

Phone: +420 224 910 221

Fax: +420 224 910 218

E-mail: info@triumphboard.com

www.triumphboard.com

Notices

Every effort has been made to ensure all information contained in this user guide is correct, but the accuracy or completeness is not guaranteed. Before using this product, you must evaluate it and determine if it is suitable for your intended application. You assume all risks and liability associated with such use. Any statements related to this product not contained in this manual or any contrary statements appearing on your purchase order shall have no force of effect unless expressly agreed upon, in writing, with this company.

Reproduction or reprinting this user guide or any part is prohibited without permission.

The content of this user manual is subject to change without prior notice.

PLEASE see our website www.triumphboard.com for updates and fresh product information in the product and support sections.