

# User Manual v 6.0

May 2013

## MULTI Touch Series

TRIUMPH BOARD 78" MULTI Touch

TRIUMPH BOARD 89" MULTI Touch

TRIUMPH BOARD 96" MULTI Touch

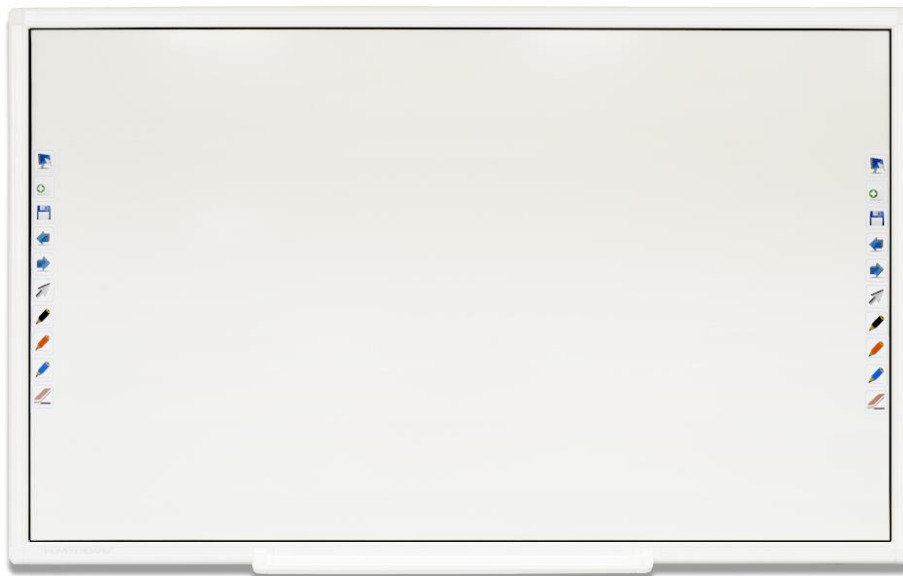

# Content



1) Safety Information .....	3
2) Product Description .....	7
3) Technical Specifications .....	8
4) Package contents.....	11
5) Wall mount Installation .....	12
6) Software Installation.....	16
7) HW Installation .....	17
8) MULTI Touch Driver Configuration .....	20
a) Wireless Setting.....	20
d) Settings.....	22
9) Hotkey Setting.....	23
a) TB Comenius MULTI Touch v6 .....	23
b) RM Easiteach .....	24
10) MS Office Annotations (only for Vista & Windows-7,8 ).....	26
11) Repair Service and Contacts .....	27

## 1) Safety Information

**Please read, understand and follow the information contained in this User Guide before installation and use this product.**

### Safety Information

This product was designed, and intended for use indoor via a USB cable or wireless USB receiver connected to a desktop or laptop computer. Use this product in an outdoor and/or wet environment could damage this product and create a potentially unsafe operating condition

Meaning of Signal Words	
 <b>WARNING</b>	Indicates a potential hazard that could result in serious injury or death and/or property damage.
 <b>CAUTION</b>	Indicates hazards that could result in minor or moderate injury and/or property damage.

### **WARNING**

- Please read, understand and follow all safety information contained in this User Manual before installation and use this product.
- Do not use this product in an outdoor and/or wet environment.
- Do not use this product near water. Electric shock will result.
- This product is not intended for use by unsupervised children. Always provide proper adult supervision when using this product around children.
- At least two qualified service technicians should perform the installation and removal procedure. Failure to do so could result in serious personal injury and/or damage from dropping this product.
- Before installation, take the wall material and wall strength into consideration.
- Always place this product on a stable and level surface.
- Use only the designated wall mount and mobile stand hardware.
- Follow all installation instructions carefully.
- Make sure the mounting screws are properly sized to handle the weight of this product.
- Make sure the mounting hardware is securely anchored to a solid structure.
- Only plug the power cord, power plug or power adaptor into an AC power outlet with the proper and

Safety Information (Continue....)



indicated power supply voltage and is effectively grounded (earthed) through the normal wiring. If this product is used at a power supply voltage other than the one indicated, it would fail and may result in fire or electric shock.

- If the power cord or power plug or power adaptor cannot be plugged into the AC power outlet, contact a licensed electrician to replace the AC power outlet with a properly grounded (**earthed**) one.
- When you operate this product, the AC power outlet should be near this product and easily accessible.
- The fact that this product operates satisfactorily does not imply that the AC power outlet is grounded (**earthed**) and that the installation is completely safe. For your safety, if in any doubt about the effective grounding (earthing) of the AC power point, consult a qualified electrician.
- Do not defeat the purpose of the grounding (Earthing) plug (for example, do not use a conversion plug).
- Always plug the power cord, power plug or power adaptor securely and firmly into an AC power outlet. Otherwise, overheating will occur, possibly resulting in electric shock or fire.
- Do not pull, bend, rest objects on, or chafe the power cord or power plug or power adaptor. Damage to the power cord or power plug or power adaptor can cause fire or electric shock.
- Do not attempt to repair the power cord, power plug or power adaptor. If the power cord or power plug or power adaptor is damaged or frayed, contact an authorized service representative for a replacement.
- Periodically clean the power cord or power plug or power adaptor to ensure the connection is free of dust. In a damp environment, a contaminated connector can draw a significant amount of current that can generate heat and eventually cause fire if left unattended over an extended period of time.
- Never move the power cord or power plug or power adaptor with wet hands. Electric shock will result.
- Stop operation immediately if your product emits smoke, excessive heat, abnormal smell or unusual noise. These conditions can cause fire or electronic shock. Immediately turn your product off and unplug the power cord or power plug or power adaptor, and contact an authorized service representative for service.
- When disconnecting this product, hold the power plug or the power adaptor instead of the power cord. Pulling on a power cord forcibly can damage it and cause fire or electric shock.
- To prevent fire or shock hazard, do not expose this product to rain or any type of moisture.
- If metal objects or a liquid get into this product, turn this product off and unplug this product immediately. Contact an authorized service representative for service. Operating the contaminated product can cause fire or electronic shock.
- Never open or remove unit covers that are screwed with screws. A high-voltage component can cause electric shock.
- Do not alter this product or modify any parts. Alteration or modification can cause fire or electronic shock.
- Before cleaning this product, unplug the power cord or power plug or power adaptor as electric shock may result.

Safety Information (Continue....)



- Do not open or alter the casing of this product. Electric shock or injury may result.
- Be careful about the location of the power cord, power plug or power adaptor to avoid that it trips someone or causes this product to fall, etc. It may cause injury or product failure.
- Do not leave this product or any of its accessories on the floor to avoid someone breaking it when stepping on it or injury by tripping on it.
- Use only the included power cord or power plug or power adaptor. If other power cord or power plug or power adaptor is used, fire or electric shock might result.
- Do not operate this product in a location with high temperature or high humidity. This product is suitable to work under: Temperature: 10°C to 40°C; Humidity: 10% to 80%; NO condensation.
- Unplug the power cord, power plug or power adaptor from the AC power outlet when:
  - The power cord or power supply plug is damaged.
  - A liquid is spilled onto this product.
  - This product is exposed to rain or water.
  - This product becomes malfunctions and/or need repairing.
  - This product falls or after its cabinet is damaged.



- This product must be disposed in accordance with the relevant federal, state, and local laws and regulations.
- Do not install this product other than by a qualified service personnel.
- Avoid fire and heat source above 100°C.
- When this product is not used over an extended period of time, switch it off and unplug the power plug or power adaptor. If it is unused and is left connected to a power source for a long period, degraded insulation may cause electronic shock, current leakage or fire.
- Do not position this product in a location where it is unstable.
- Do not place this product in a hot humid or dusty environment. Prolonged exposure to these adverse conditions may cause fire or electric shock.
- When moving this product, be sure to unplug the power cord, plug or power adaptor from the AC power outlet. If this product is moved with the power cord or plug or power attached, it can cause damage to the power cord, plug or power adaptor which could result in fire or electric shock.
- After installing or moving this product, lock the casters when it is hanging on a mobile stand.
- If this product falls down or gets damaged, turn this product off and unplug the power cord or power plug or power adaptor. Otherwise, it may cause fire or electric shock.
- Do not put drinks, other liquids or heavy items on the tray or screen. Accidental spillage of liquid into this product may cause severe damage. If this occurs, turn this product off, unplug the power cord or power plug or power adaptor and contact an authorized service representative for service.

 **CAUTION**

- Do not lean against this product even when this product is mounted on the wall.
- Do not install this product where it may be exposed to direct sunlight, near heating equipment, or near air-conditioning vents.
- Do not install this product in strong sunlight or strong lighting.
- Do not install this product in locations where the temperature may change suddenly.
- Do not allow writing to remain on the screen for an extended period of time as it will become harder to erase.
- Do not erase with an overly dirty eraser.
- Use commercially available white board cleaner for hard-to-erase stains.
- Use only designated markers and erasers. Use of accessories other than those authorized (such as oil-based markers) may damage the screen or result in hard-to-erase markings.
- Fasten the screws tightly to avoid that the stand or this product falls which may cause injury or damage.
- Before installation, take the wall material and wall strength into consideration. For details, please consult your dealer.

## 2) Product Description

TRIUMPH BOARD MULTI Touch is an interactive whiteboard that allows four users to write, draw, move objects or two users to resize and rotate two objects with two fingers per object simultaneously. Truly multi-touch, requiring no separate multiuser mode settings. Users can write, draw and move objects with a finger, stylus or even a pointer.

TRIUMPH BOARD MULTI Touch connects to a computer through a fast USB 2.0 interface or optionally with wireless radio technology with 2,4 GHz, just plug-n-play, makes the lecture more interactively and enhances the efficiency of the class

TRIUMPH BOARD MULTI Touch supports Linux, Mac, all Microsoft Windows & multiuser writing and common multi touch gestures currently recognized in Microsoft Win-7, 8. Use simple intuitive finger or hand gestures to toss, rotate or zoom in/out on objects

TRIUMPH BOARD MULTI Touch is based on IR Cell LED Optical technology which uses a combination of IR LEDs and photo transistors that are aligned in pairs around the active surface. These pairs of LEDs and photo transistors cast a grid over the surface. When the surface is touched, the beam of infrared light between the LEDs and the photo transistors is interrupted at the point of touch. This position is converted into an 'X' and a 'Y' coordinate which the computer then converts into a mouse position.

TRIUMPH BOARD MULTI Touch interactive whiteboards are used in classrooms at all levels of education, in corporate board rooms and training rooms, in professional sports coaching, etc. Interactive whiteboards replace traditional whiteboards, flipcharts and other traditional systems

**For proper functioning of 4 users simultaneous writing on the whiteboard it is recommended to write at least 10 to 15 cm apart from each other and at different heights.**



MULTI Touch 78"



MULTI Touch 89"

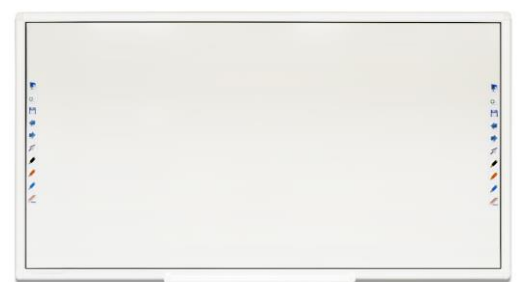

MULTI Touch 96"

### 3) Technical Specifications

#### TRIUMPH BOARD 78" MULTI Touch

EAN:	8592580101601
Active screen area size:	1576 x 1168, 78" diagonal
Aspect ratio:	4:3
Technology:	IR (Infrared) cell LED optical
Resolution:	12800x9600
Projection screen area:	1557 x1168 mm
Interface Type:	USB 2.0 / 2.4 GHz RF Wireless (optional)
Cable Length:	6 m
Working Environment	-20 to 40°C
Response time:	6ms
Power supply:	USB DC 5V from PC (optional wireless PC receiver and USB adaptor /220V)
Power consumption:	< 260 mA (wireless PC receiver 20mA)
Temperature Range:	-20 to 40°C, storage temperature - 40 to 70°C
Humidity Operating	30-90% non-condensing, storage 0-95%, noncondensing
Platform:	Windows 8, 7, XP and Vista, Linux, MAC
Board size without packing:	1693 x1284x35 mm (width x height x depth without plastic pen tray)
Board size with packing:	1869 x 1395 x 67 mm (width x height x depth without plastic pen tray)
Optional:	Speakers, Active Pen Tray, various Stands and Lift Systems

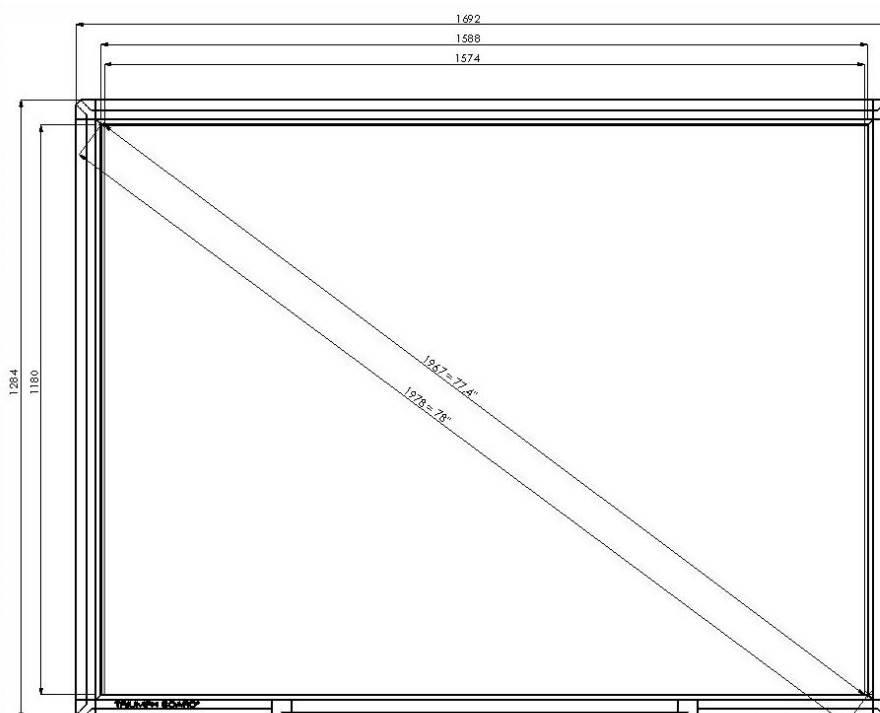



## TRIUMPH BOARD 89" MULTI Touch

EAN:	8592580101618
Active screen area size:	1944 x 1127, 89" diagonal
Aspect ratio:	16:10 (with hotkeys), 16:9
Technology:	IR (Infrared) cell LED optical
Resolution:	12800x9600
Projection screen area:	1803 x 1127 mm (with the hotkeys)
Interface Type	USB 2.0 / 2.4 GHz RF Wireless (optional)
Cable Length	6 m
Working Environment	-20 to 40°C
Response time:	6ms
Power supply:	USB DC 5V from PC (optional wireless PC receiver and USB adaptor /220V)
Power consumption:	< 280 mA (wireless PC receiver 20mA)
Temperature Range:	-20 to 40°C, storage temperature - 40 to 70°C
Humidity Operating:	30-90% non-condensing, storage 0-95%, non-condensing
Platform:	Windows 8, 7, XP and Vista, Linux, MAC
Board size without packing:	2060 x 1244 x 35 mm (width x height x depth without plastic pen tray)
Board size with packing:	2236 x 1355 x 67 mm (width x height x depth without plastic pen tray)
Board weight (net):	31,5 kg
Weight incl. packing:	39,5 kg
Optional:	Speakers, Active Pen Tray, various Stands and Lift Systems

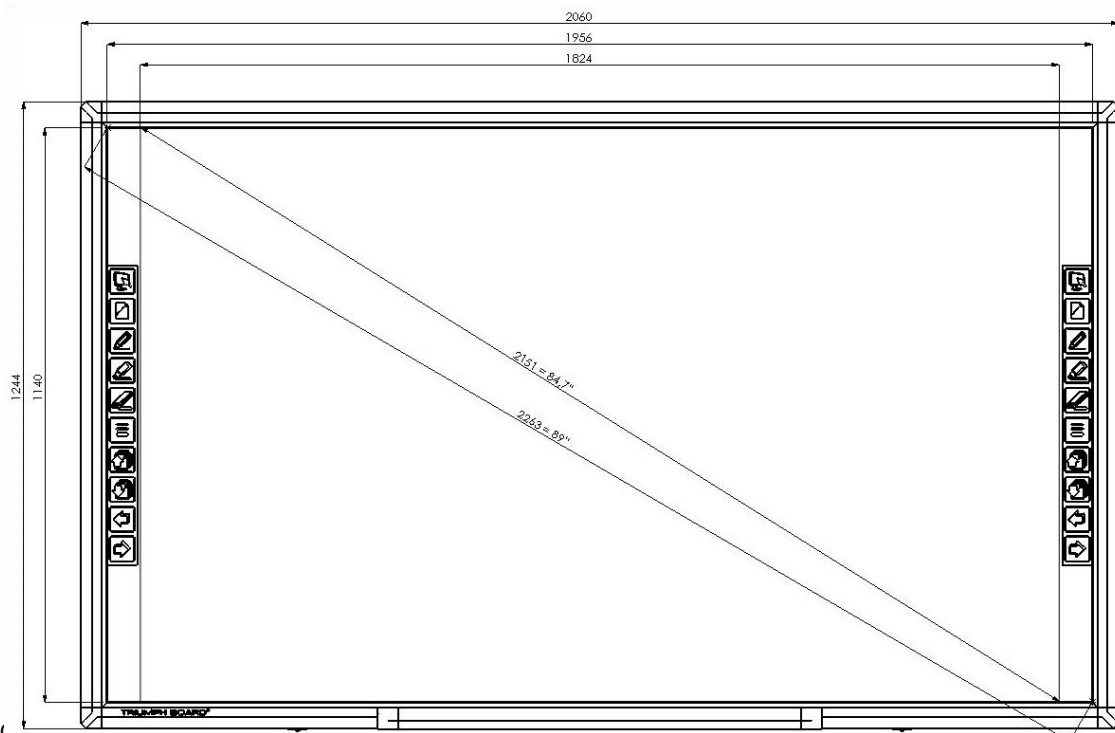

## TRIUMPH BOARD 96" MULTI Touch

EAN:	8592580101625
Active screen area size:	2145 x 1127, 96" diagonal
Aspect ratio:	16:9
Technology:	IR (Infrared) cell LED optical
Resolution:	12800x9600
Projection screen area:	2044 x 1127 mm (with the hotkeys)
Interface Type:	USB 2.0 / 2.4 GHz RF Wireless (optional)
Cable Length:	6 m
Working Environment:	-20 to 40°C
Response time:	6ms
Power supply:	USB DC 5V from PC (optional wireless PC receiver and USB adaptor /220V)
Power consumption:	< 290 mA (wireless PC receiver 20mA)
Temperature Range:	-20 to 40°C, storage temperature - 40 to 70°C
Humidity Operating:	30-90% non-condensing, storage 0-95%, non-condensing
Platform:	Windows 8, 7, XP and Vista, Linux, MAC
Board size without packing:	2264 x 1264 x 35 mm (width x height x depth without plastic pen tray)
Board size with packing:	2441 x 1355 x 67 mm (width x height x depth without plastic pen tray)
Optional:	Speakers, Active Pen Tray, various Stands and Lift Systems

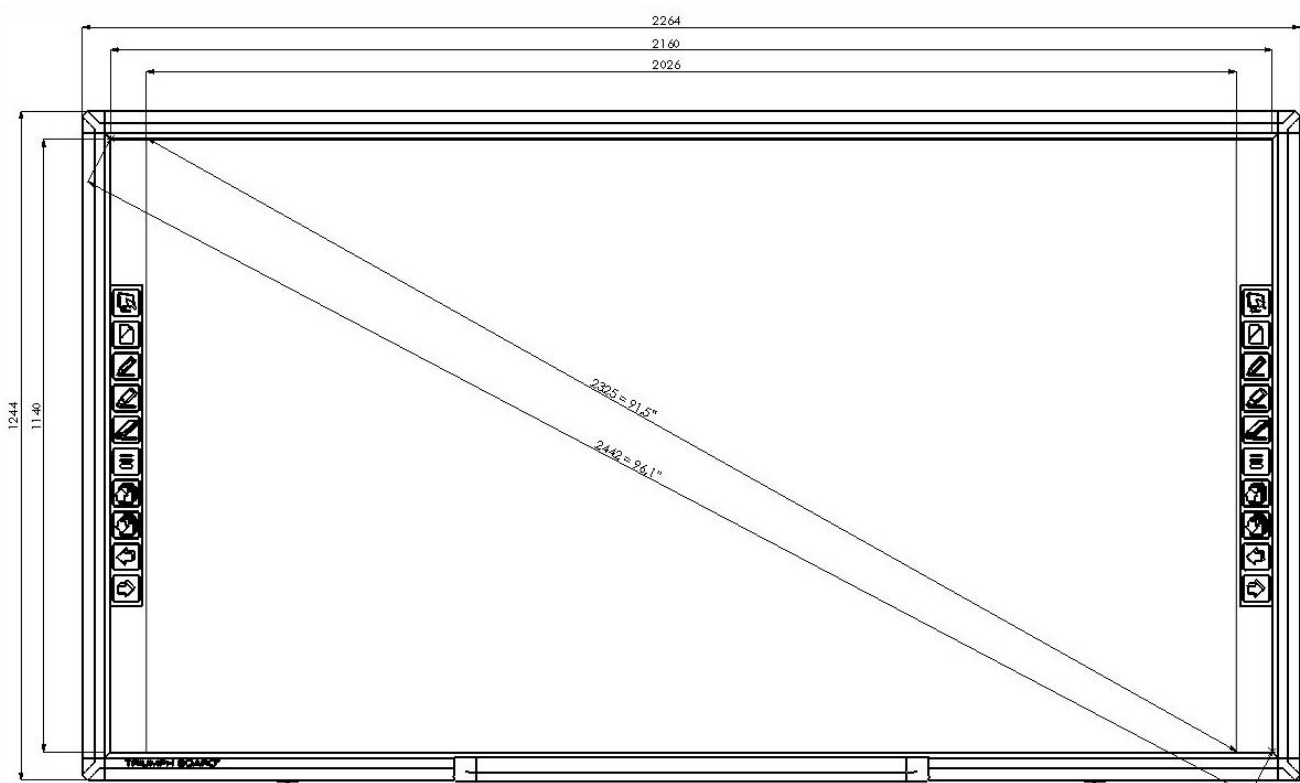

## 4) Package contents

After unpacking, please make sure all of the following parts (subject to your purchase) are present

MULTI Touch – USB / Wireless ready		
Item	Description	Quantity
1	Whiteboard with built-in IR Sensor	1
2	USB Cable	1
3	Pen tray	1
4	TB Comenius Hotkey strip ( 78" 20*20 mm included – rear of board/ 89",96" 50*50 mm stucked on the board )	2
5	RM Easiteach Hotkey strip ( 20*20 / 50*50 mm included – rear of board)	
6	Stylus ( plastic pen )	2
7	Eraser	1
8	Hard Copy User Manual incl. mounting instructions	1
9	TB Comenius – Software CD with soft copy user manual	1
10	MyScript Stylus - Software CD	1
11	RM Easiteach - Software DVD	1
12	Installation components set	1

## 5) Wall mount Installation MULTI Touch 78"

- 1) attach suspender (6) by screwing to board
- 2) measure the position of top hangers for hanging (3)
- 3) install wall plugs (1) and hangers (3)
- 4) install pentray on board
- 5) measure and install wall plugs (1), screws (2) and square (4)
- 6) hang board

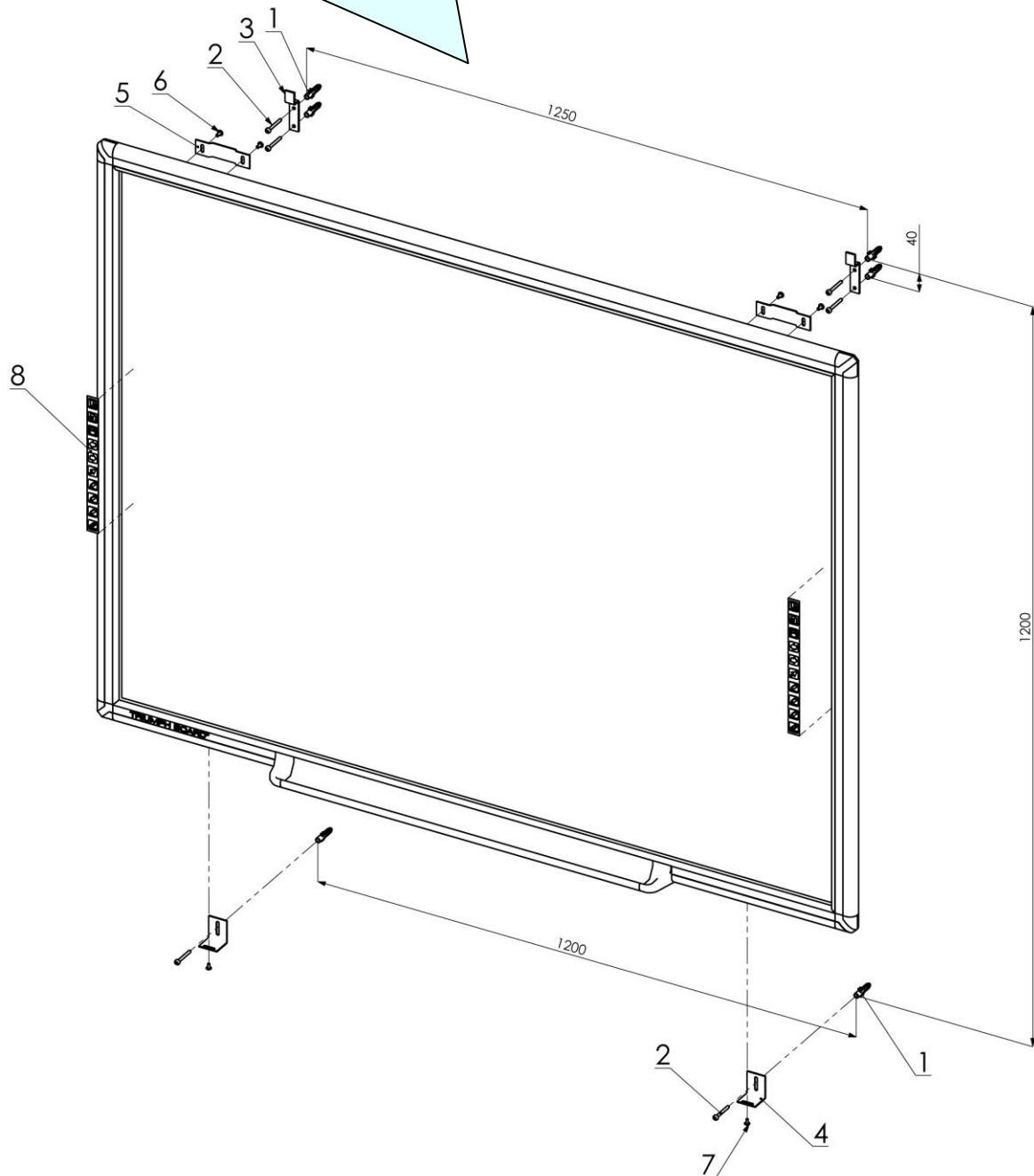

MULTI Touch 89"

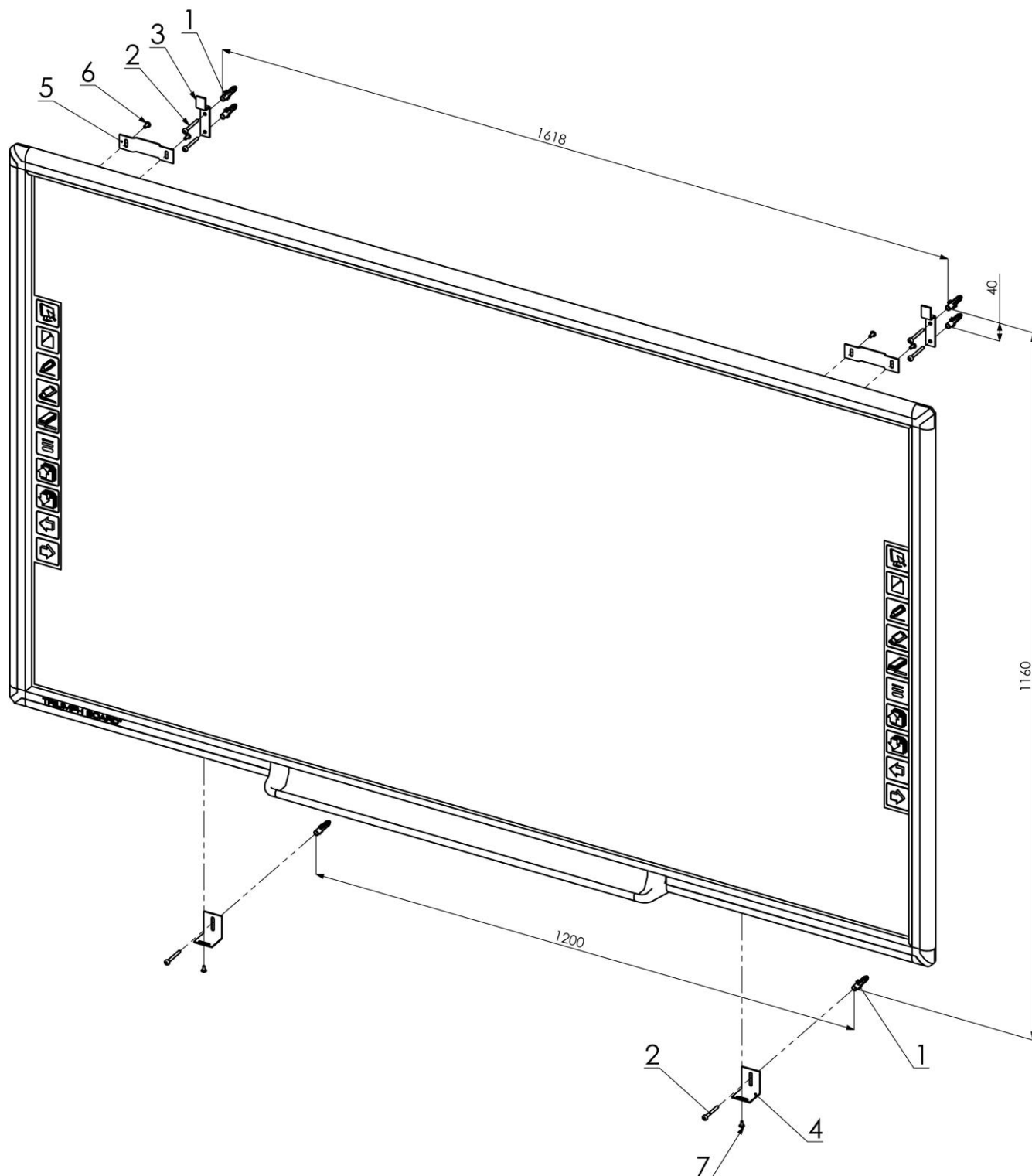

1	Wall plug 10	5	Drape
2	Screw 5x50	6	Screw M5x12
3	Hanger TB MULTI Touch	7	Screw M4x10
4	Square	8	Hotkeys

MULTI Touch 96"

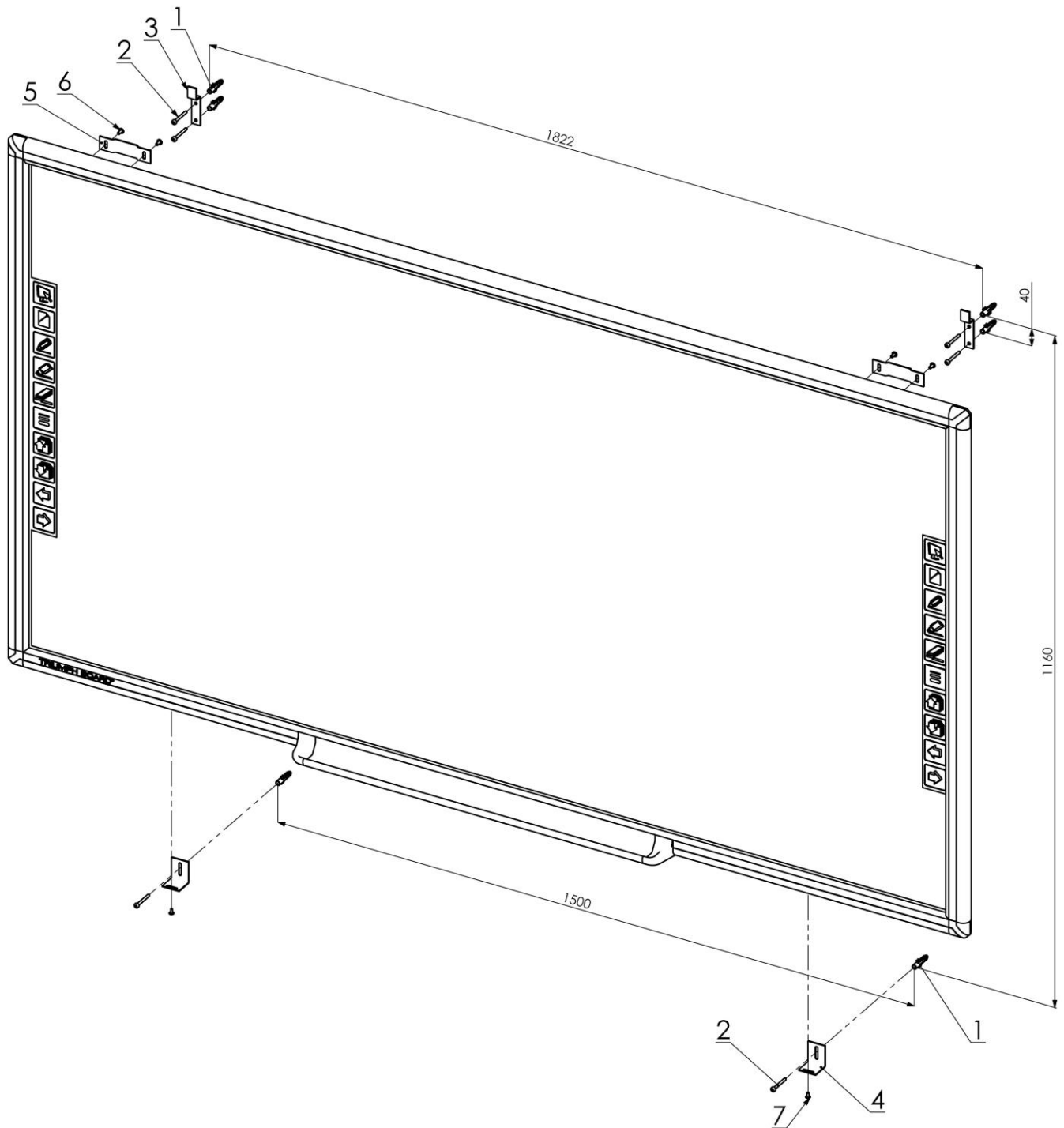

1	Wall plug 10	5	Drape
2	Screw 5x50	6	Screw M5x12
3	Hanger TB MULTI Touch	7	Screw M4x10
4	Square	8	Hotkeys

 **WARNING**

- At least two qualified service technicians should perform the installation procedure. Serious personal injury and / or damage can result from dropping this product.
- BEFORE the installation, please make sure both wall material and wall strength are suitable, otherwise, the board might fall which may cause injury and/or damage. Please consult your dealer for details.
- Use only the designated wall mount.
- Follow all installation instructions carefully.
- Make sure the mounting screws are properly sized to handle the weight of the board.
- Make sure the wall mount is firmly and securely anchored to a solid structure.
- Make sure the board is fastened firmly and securely to the wall mount before using it.

 **CAUTION**

- Do not install this product in location where it may be exposed to direct sunlight, near heating equipment, or near air-conditioning vents.
- Do not install this product in strong sunlight or strong lighting location.
- Do not install this product in location where the temperature may change suddenly.
- Avoid to install two or more of these products in the same room or adjacent to each other. Please consult your dealer for details.

## 6) Software Installation

### Install TB Comenius MULTI Touch software

- a) To run the Installation Program, double-click file “TB Comenius MULTI Touch.exe”.  
Then click “Next” to install the software.

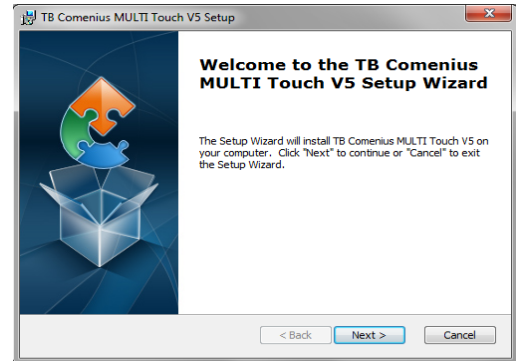

- b) Choose destination location and click “Next” to continue.

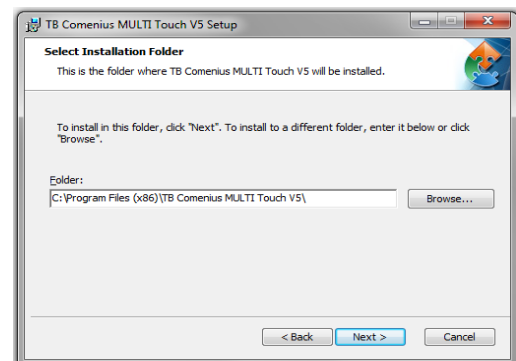

- c) Click Install

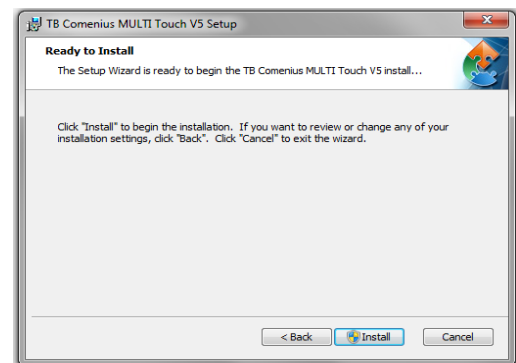

- d) Click “Finish” to exit upon the MULTI Touch software has been successfully installed.

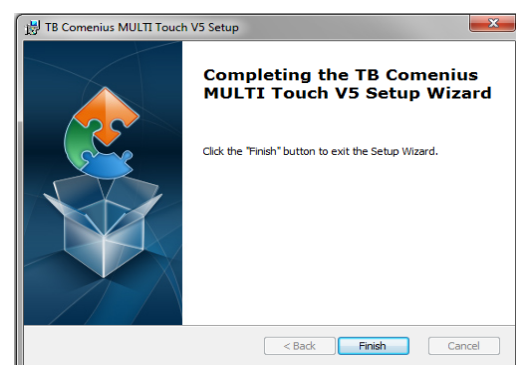

- e) Connect your PC / laptop with the MULTI Touch by using USB cable (provided).



f) MULTI Touch - USB or MULTI Touch - Wireless Receiver has been detected and is ready to use when the following dialogue is shown.



## 7) HW Installation

### Connection

User must have PC, projector, MULTI Touch - USB or MULTI Touch - Wireless Receiver and connect them as shown in the figure below.

### MULTI Touch – USB cable – Computer

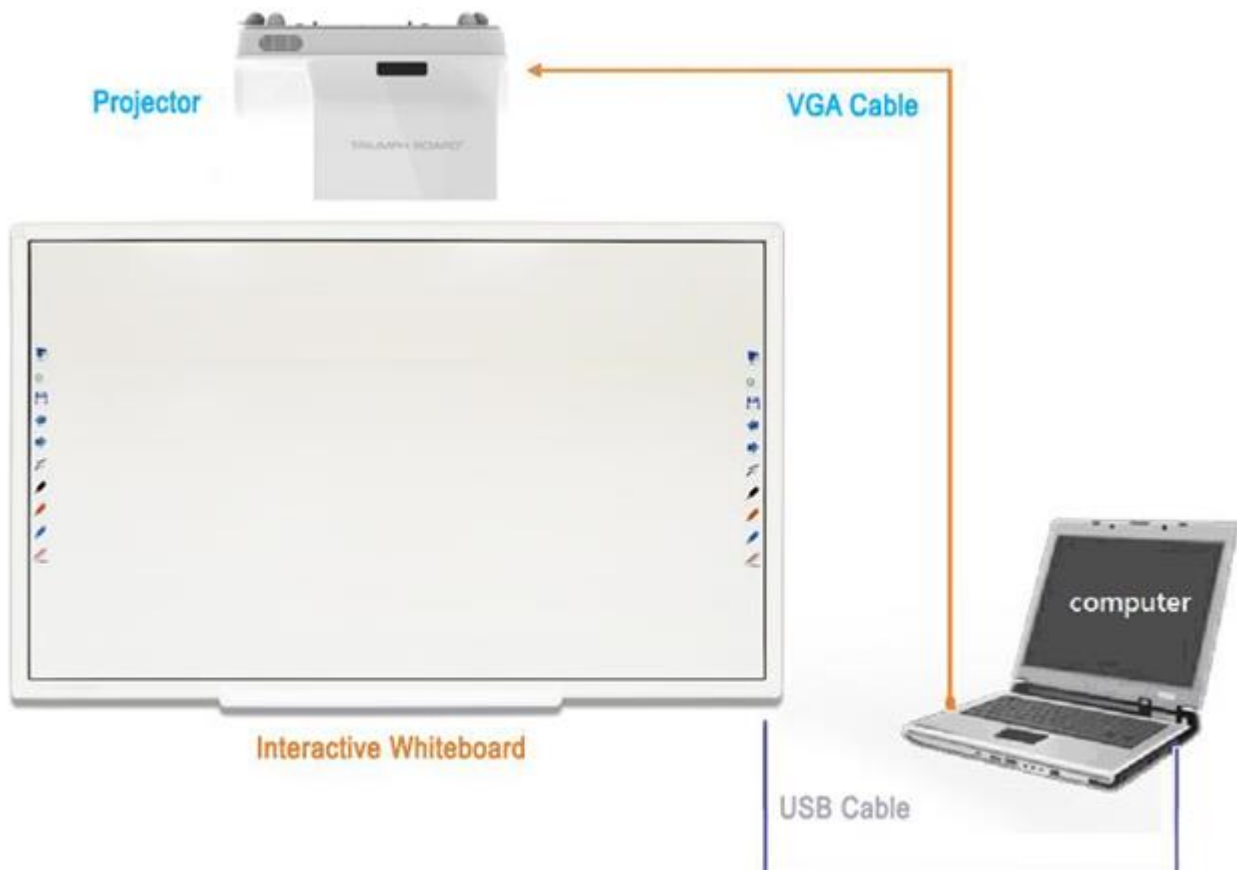

## Mounting and connecting HDMI-> micro USB and 6 m USB cable

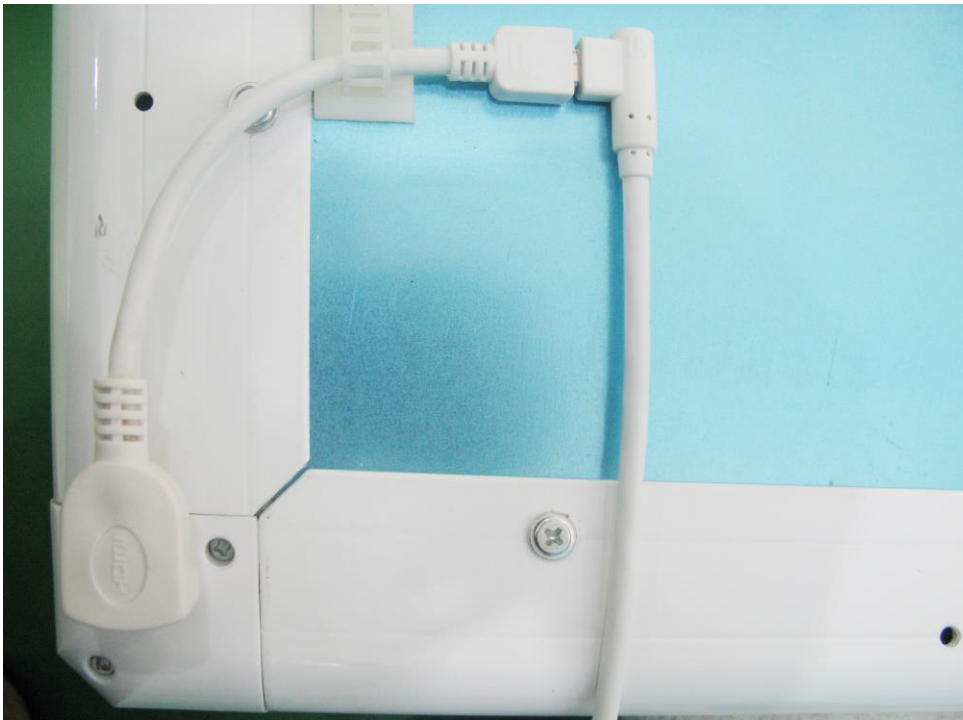

## MULTI Touch - Wireless - Computer

Once the connection is completed, adjust the position of the video projector until the projected Windows screen on the board is within the whiteboard working area.

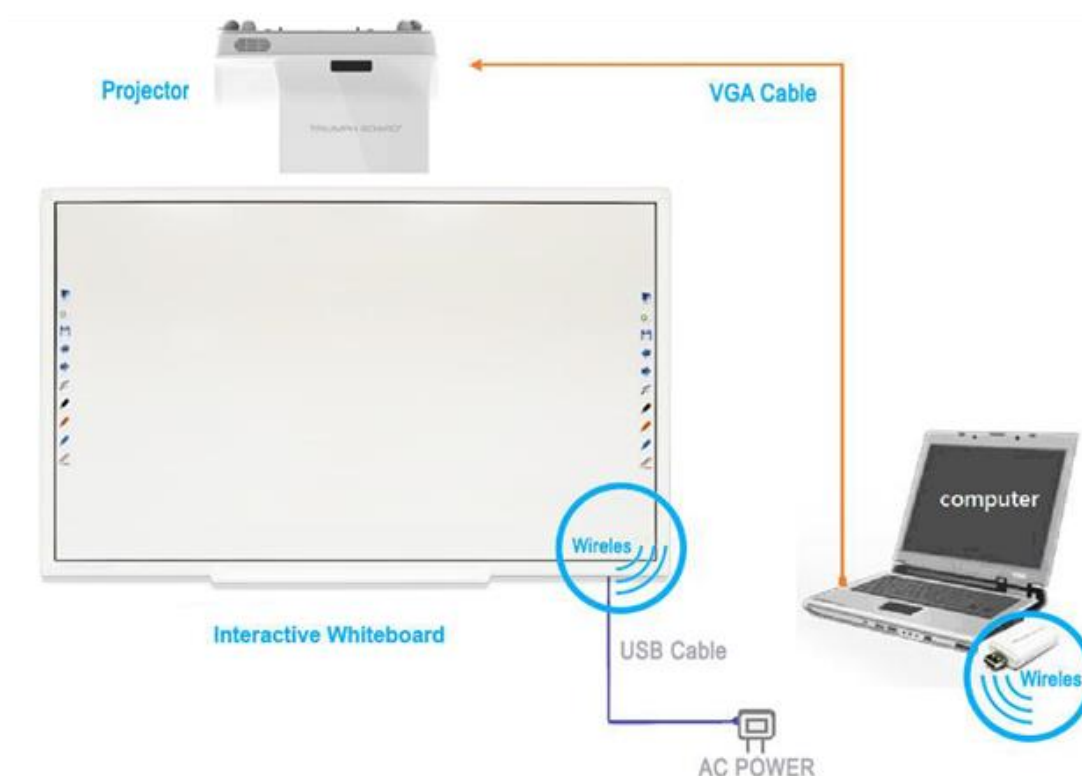

## Connection of WR Antenna (optional)



## 8) MULTI Touch Driver Configuration



### MULTI Touch configuration Main Manual

Right click the icon to show the Main Menu of MULTI Touch configuration.



### a) Wireless Setting

For wireless use you need to order **MULTI Touch Wireless Upgrade Kit** (EAN 8592580092015) which includes WR HUB with antenna, USB WR Receiver and Power Adaptor. This Wireless kit works only with MULTI Touch board Series.

30 wireless channels are available for selection.

To change channel or pairing your MULTI Touch board, click “scan” then the detected sensors will show on the table.

Select the “IWB Name” on the list and click “Pair” to make pairing for the Receiver and Sensor. It is recommended to rename the Sensor unit after pairing so as not to mix up with other sensors installed nearby.

Click “Un-pair” to release channel lock.

Make sure to click “Un-pair” and re-do pairing if Sensor Unit or Wireless Receiver has been changed.

*\*IWB = Interactive White Board*

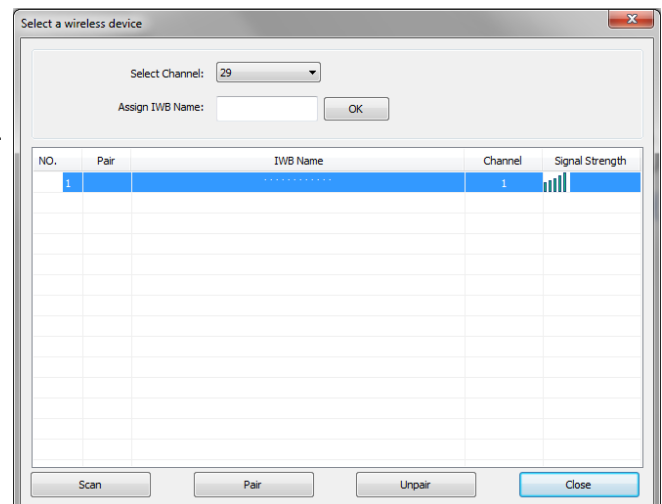

### b) Calibration

Calibration for MULTI Touch after first time installation or if the projector size and projector’s position has changed.

Click the flashing cross to calibrate, press ESC to exit. Touch each coordinate accurately. The coordinates will be moved continually until the calibration is completed.

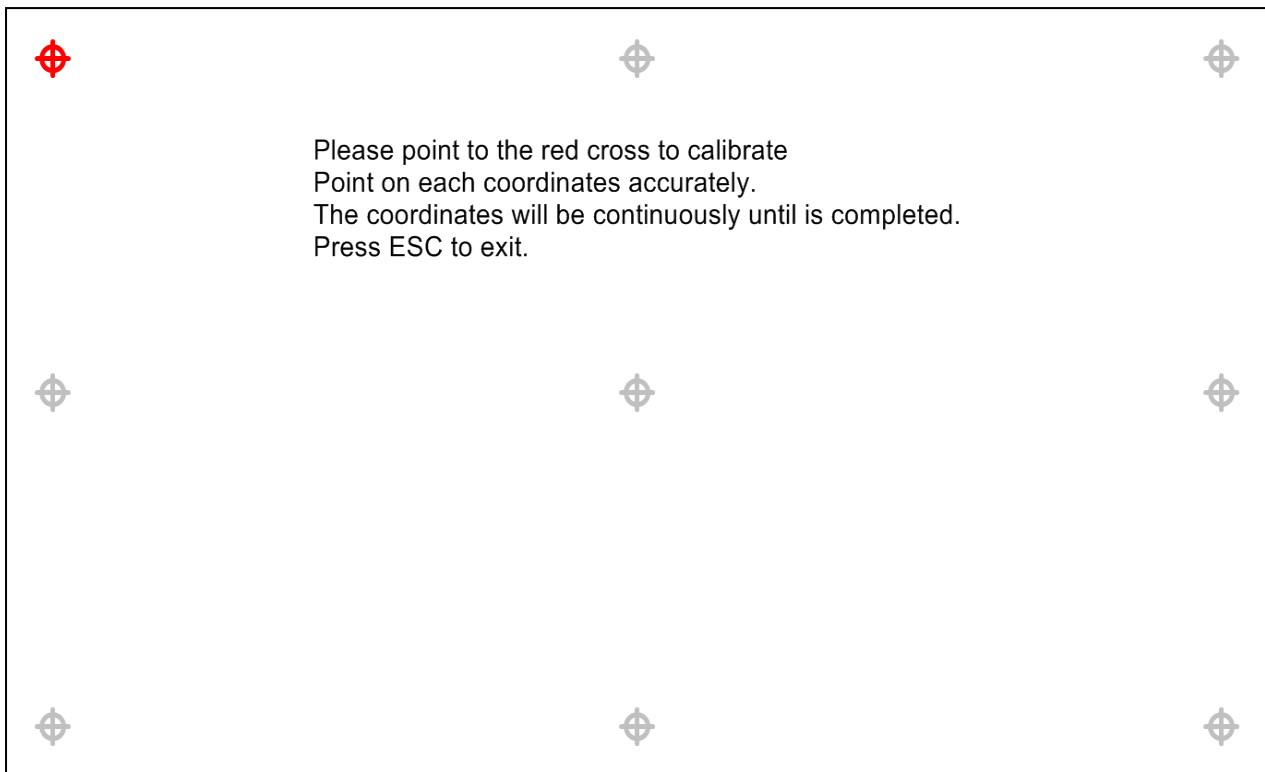

### c) User profile

When Calibration records on the computer, it is not necessary to re-do in the same room with the same computer. User just selects the calibration profile from the record.

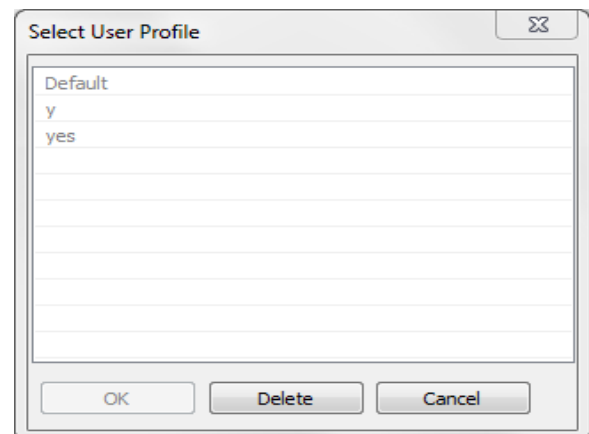

**User can select location profile when using MULTI Touch in the same location next time.**

## d) Settings

### Device Information

After successfully connecting the computer with the whiteboard, device information such as wireless or USB version and firmware version info will be shown.

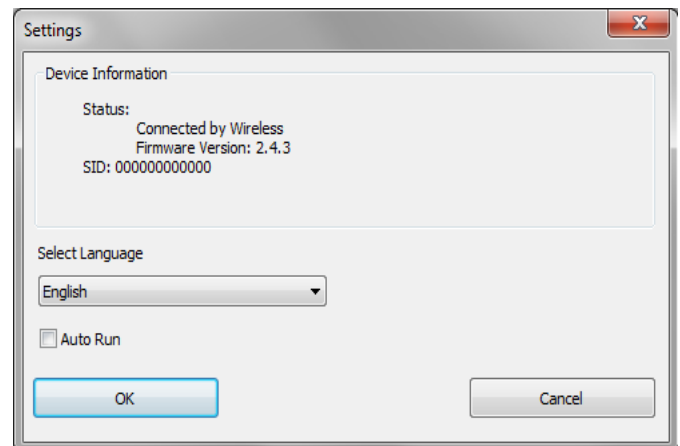

### Language

You can choose one of the 24 language localizations under Settings/Select Language

### Auto Run

If user enables auto run, the MULTI Touch board driver will automatically start with each restart of windows.

If the MULTI Touch board is not used every day you can choose to disable auto run.

## 9) Hotkey Setting

2 x 10 hotkey features are available in TB Comenius MULTI Touch v6 and RM Easiteach software for the user to set up. For the hotkeys to function properly only one Hotkeys Driver should run at a time, not both simultaneously. If both of the drivers (TB Comenius MULTI Touch Driver v6 and RM Hotkeys Driver) are installed and running, then before starting one of the programs please exit the Hotkeys Driver of the other program.

### a) TB Comenius MULTI Touch v6

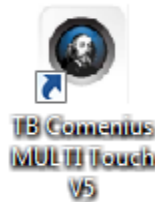

Steps are as following:

Make sure that TB Comenius MULTI Touch Driver v6 is running (TB Comenius MULTI Touch Driver v6 icon is displayed in the system tray). If not, run it by double clicking on TB Comenius MULTI Touch Driver v6 icon on your Desktop.

If RM Hotkeys Driver is running (RM Hotkeys Driver icon is displayed in system tray), click the right mouse button and select Exit to cancel it.

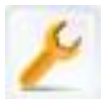

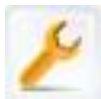
- 1) Click on Tools  in main TB Comenius MULTI Touch v6 Program menu and choose Calibration Hotkeys.

- 2) Choose Hotkey Size – 20\*20 mm for small Hotkey Strip (icons size 20\*20 mm) or 50\*50 mm for big Hotkey Strip (icon size 50\*50 mm).

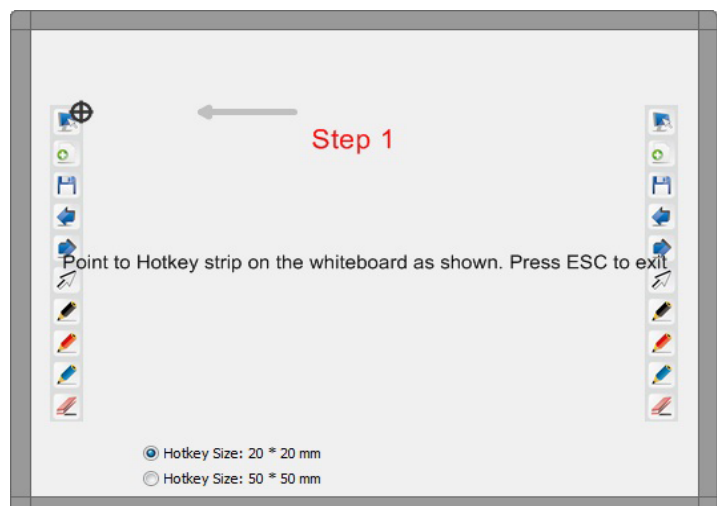

- 3) Use stylus of MULTI to point to Hotkey strip icons according to where the black/red cross is.

**b) RM Easiteach**



Installation of RM Hotkeys Driver

Install the RM Hotkeys Driver by double-click on RM Hotkeys Driver.msi. After installation run RM Hotkeys Driver by double-clicking on RM Hotkeys Driver icon on the desktop.



The RM Hotkeys Driver icon displays in Windows system tray.



Click the right mouse button in the toolbar to display a context menu.

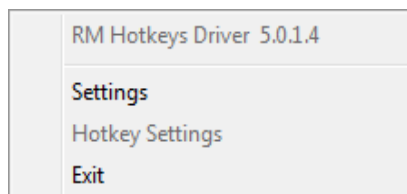

Calibration steps are as follows:

Make sure that RM Hotkeys Driver v5 is running (RM Hotkeys Driver v5 icon is displayed in the system tray). If not run it by double clicking on the RM Hotkeys Driver icon on your Desktop.

If MULTI Touch Driver is running (TB Comenius Driver icon is displayed in system tray), click the right mouse button or hold electronic pen on driver's icon and select Exit to cancel it.



- 1) Click the right mouse button or hold stylus longer on RM Hotkey Driver icon in the Windows system tray and select Hotkey Settings.
- 2) Choose Hotkey Size – 20\*20 mm for small Hotkey Strip (icons size 20\*20 mm) or 50\*50 mm for big Hotkey Strip (icon size 50\*50 mm)
- 3) Use stylus to point to corresponding Hotkey strip icons where the black/red cross is located.

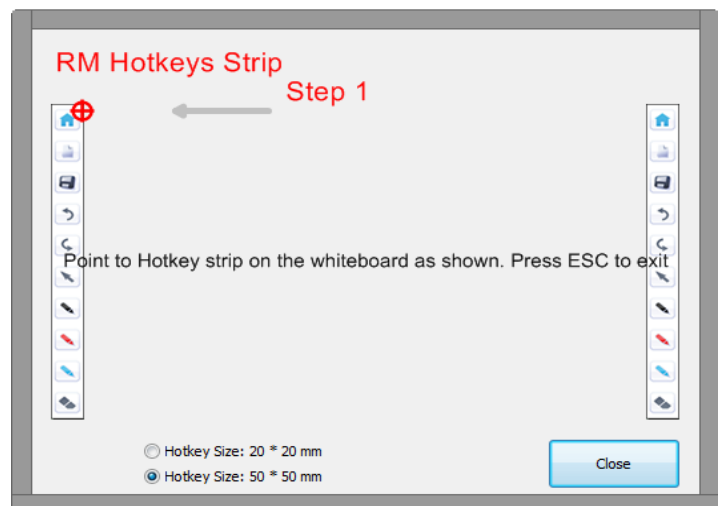

## 10) MS Office Annotations (only for Vista & Windows-7, 8)

Microsoft office Annotations toolbar will appear when the MULTI Touch board is connected with the PC

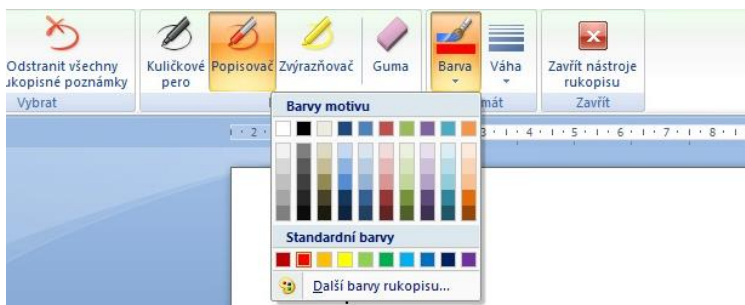
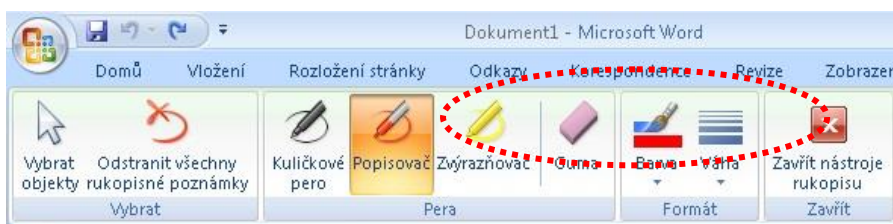
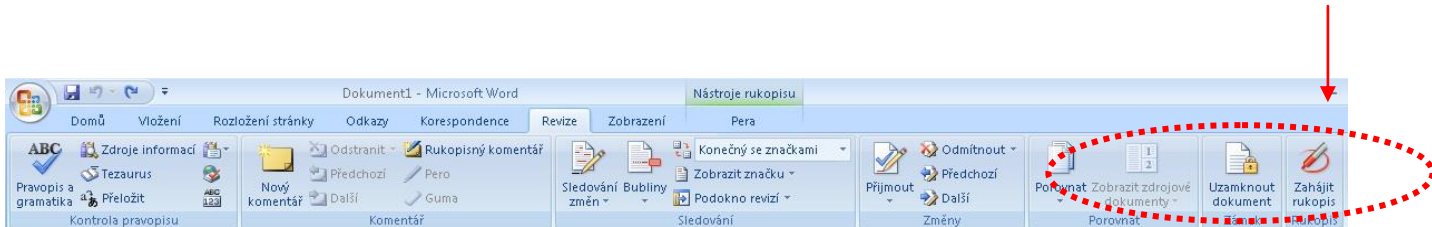

## 11) Repair Service and Contacts

Please contact your local supplier for the warranty and technical service or alternatively find all warranty conditions and service partners on our website [www.triumphboard.com](http://www.triumphboard.com) . For any questions please email us at [info@triumphboard.com](mailto:info@triumphboard.com)

**TRIUMPH BOARD a.s.**

Neklanova 122/15

128 00 Praha 2

Czech Republic

EU

Phone: +420 224910221

Fax: +420 224910218

**E-mail: [info@triumphboard.com](mailto:info@triumphboard.com)**

**[www.triumphboard.com](http://www.triumphboard.com)**

### Notices

Every effort has been made to ensure all information contained in this user guide is correct, but the accuracy or completeness is not guaranteed. Before using this product, you must evaluate it and determine if it is suitable for your intended application. You assume all risks and liability associated with such use. Any statements related to this product which are not contained in this manual or any contrary statements contained on your purchase order shall have no force of effect unless expressly agreed upon, in writing, by this company.

Without TRIUMPH BOARD's written permission, reproduction or reprinting this user guide or any part is prohibited.

The contents of this user guide are subject to change without prior notice.

**PLEASE see our website [www.triumphboard.com](http://www.triumphboard.com) for updates and fresh product information in the product and support sections.**