

## User Manual

# INTERACTIVE FLAT PANEL UHD Series

55"/ 65"/ 75"/86"

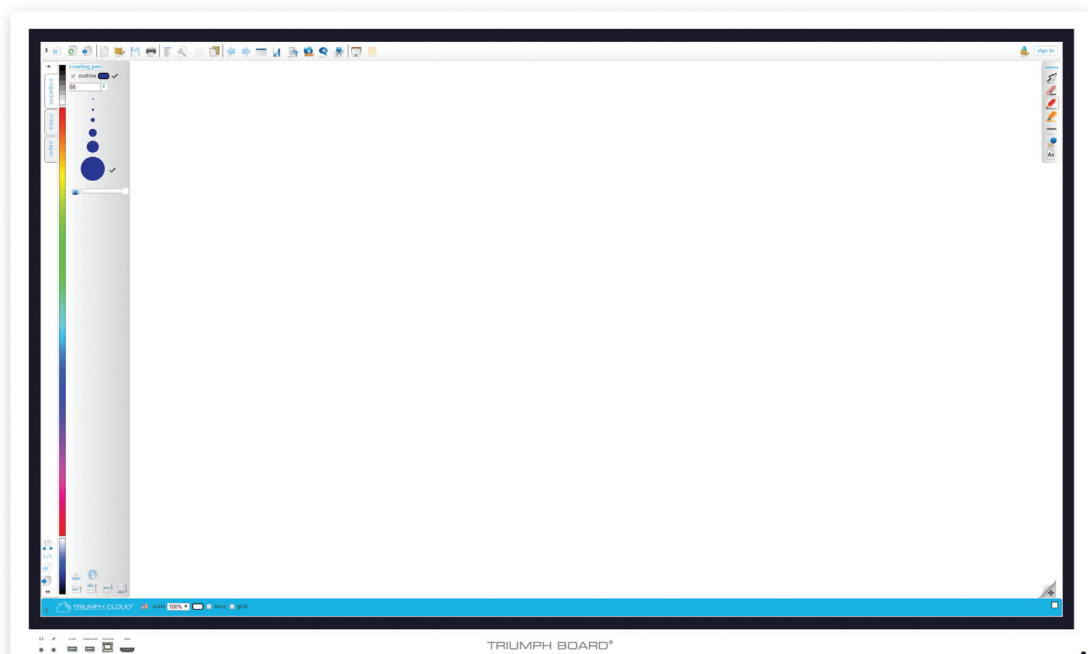

2017

## **1. Product Description**

### **TRIUMPH BOARD INTERACTIVE FLAT PANEL**

TRIUMPH BOARD INTERACTIVE FLAT PANEL is a fully integrated, professional, multi touch UHD IFP with amazing performance and stunning visuals.

TRIUMPH BOARD INTERACTIVE FLAT PANEL is an effective presentations tool for showing lessons, or presentations interactively in any classroom or meeting room. The latest IR LED optical technology allows 32 finger touch, with up to 32 users being able to write and draw using fingers or a stylus.

### **TRIUMPH BOARD OPS PC for INTERACTIVE FLAT PANEL (optional for IFP UHD Series)**

The TRIUMPH BOARD OPS PC for IFP is a powerful, fully integrated personal computer for the TRIUMPH BOARD Interactive Flat Panel Series with the Android system.

TRIUMPH BOARD OPS PC for IFP includes a license of Microsoft® Windows® 10 Pro (OEM) with selection of language options and preinstalled applications

## 2. Technical Specifications

### TRIUMPH BOARD 55" INTERACTIVE FLAT PANEL

EAN:	8592580113215
Screen Type:	Open Cell DLED Backlight
Resolution:	3840 × 2160
Brightness:	350 cd/m <sup>2</sup>
Contrast:	1200:1
Response time:	6 ms
Refreshing Frequency:	60 Hz
Display Area:	1238,48 (H) x 709,52 (V) mm (56.2" H x 27.9" V)
Outline Dimensions:	1299 x 673 x 122 mm (59.4" x 34.9" x 4.8")
Package Dimensions:	1520 x 1165 x 320 mm (59.8" x 12.6" x 45.8")
Net / Gross weight:	39,6 / 54,7 kg (87.30 / 120.6 lb)

### TRIUMPH BOARD 65" INTERACTIVE FLAT PANEL

EAN:	8592580113222
Screen Type:	Open Cell DLED Backlight
Resolution:	3840 × 2160
Brightness:	450 cd/m <sup>2</sup>
Contrast:	1200:1
Response time:	6 ms
Refreshing Frequency:	60 Hz
Display Area:	1428,48 (H) x 803,52 (V) (56.85" H x 32.28" V)
Outline Dimensions:	1510,5 x 886,5 x 122 mm (59.4" x 34.9" x 4.8")
Package Dimensions:	1765 x 1165 x 320 mm (69.5" x 12.6" x 45.9")
Net / Gross weight:	49,85 / 68,5 kg (109.9 / 151 lb)

### TRIUMPH BOARD 75" INTERACTIVE FLAT PANEL

EAN:	8592580112638
Screen Type:	Open Cell DLED Backlight
Resolution:	3840 × 2160
Brightness:	450 cd/m <sup>2</sup>
Contrast:	1200:1
Response time:	6 ms
Refreshing Frequency:	60 Hz
Display Area:	1649,66 (H) x 927,94 (V) mm (64.92" H x 36.5" V)
Outline Dimensions:	1736,8 x 1035,3x 108 mm (68.38" x 40.75" x 4.25")
Package Dimensions:	1990 x 1165 x 320 mm (78.35" x 45.87" x 12.6")
Net / Gross weight:	61,15 / 87,7 kg (134.8 / 193.3 lb)

## **TRIUMPH BOARD 86" INTERACTIVE FLAT PANEL**

EAN:	8592580112645
Screen Type:	Open Cell DLED Backlight
Resolution:	3840 × 2160
Brightness:	400 cd/m <sup>2</sup>
Contrast:	1200:1
Response time:	6 ms
Refreshing Frequency:	60 Hz
Display Area:	1895,04 (H) x 1065,96 (V) mm (74.6" H x 41.97")
Outline Dimensions:	1990 x 1181 x 114,5 mm (78.35" x 46.5" x 4.5")
Package Dimensions:	2200 x 1490 x 360 mm (86.61" x 58.66" x 14.2")
Net / Gross weight:	93,3 / 121 kg (205.6 / 266.8 lb)

## **Touch System**

Touch Input:	32 Touch Input (Windows support with driver)
Sensing Type:	Infrared Transmission (multi-touch)
Response Time:	< 10 ms
Output Coordinates:	32768×32768
Communication Mode:	HDMI 2.0 and Full-speed USB
Writing Screen:	Mohs hardness of 7
Outline Dimensions:	1736,8 x 1035,3x 108 mm (68.38" x 40.75" x 4.25")
Package Dimensions:	1990 x 1165 x 320 mm (78.35" x 45.87" x 12.6")
Net / Gross weight:	61,15 / 87,7 kg (134.8 / 193.3 lb)

## Inputs and Outputs

HDMI IN:	5 *
HDMI OUT:	1
VGA:	1
PC AUDIO:	1
Y Pb Pr:	1
LAN:	1
AV:	1
AV OUT:	1
EARPHONE:	1
SPDIF:	1
USB 2.0:	2
USB3.0:	2
PC USB:	2
TOUCH USB:	5**
AUDIO:	1
MIC:	1
RS232 IN/OUT	1/1

\*75" IFP 4xHDMI  
\*\*75" IFP 4x TOUCH USB

## Sound System

Power Amplification:	2x20W
Sound:	Surround

## Power

Power Requirements:	100 – 240 V AC 50/60 Hz
Overall Power Consumption:	< 170W/200W/320W/500W*
Standby Power Consumption:	< 0,5 W

\* depends on the model

## Ambient Conditions

Operation Temperature	0°C ~ 40°C
Operation Humidity:	20% ~ 80% RH
Storage Temperature:	- 10°C ~ 60°C
Storage Humidity:	10% ~ 60% RH

**TRIUMPH BOARD OPS PC for IFP (for IFP UHD Series)**

EAN:	8592580113758
Processor:	Intel i3
Graphics:	Integrated Intel® HD Graphics
Sound Card:	Integrated High Definition Audio Stereo
Networking:	Integrated 10/100/1000 Mbps
Memory:	8 GB DDR4
Hard Drive:	128 GB SSD disk
WIFI:	802.11 ac (2,4/5 GHz) + Bluetooth 4.0
USB:	1x USB 2.0 and 2x USB 3.0
Lan Port (RJ45):	1
VGA Out:	1
HDMI Output	1
Audio:	Side Headphone and Mic Ports
Operation System:	Microsoft Windows 10 Professional (OEM) 64-bit MultiLang
Net / Gross Weight:	1 / 1.3 kg (2.2 / 2.8 lb)

**TRIUMPH BOARD OPS PC PRO for IFP (for IFP UHD Series)**

EAN:	8592580113307
Processor:	Intel i7
Graphics:	Integrated Intel® HD Graphics
Sound Card:	Integrated High Definition Audio Stereo
Networking:	Integrated 10/100/1000 Mbps
Memory:	8 GB DDR4
Hard Drive:	256 GB SSD disk
WIFI:	802.11 ac (2,4/5 GHz) + Bluetooth 4.0
USB:	1x USB 2.0 and 2x USB 3.0
Lan Port (RJ45):	1
VGA Out:	1
HDMI Output	1
Audio:	Side Headphone and Mic Ports
Operation System:	Microsoft Windows 10 Professional (OEM) 64-bit MultiLang
Net / Gross Weight:	1 / 1.3 kg (2.2 / 2.8 lb)

**Android System**

Version:	Android 5.0
CPU:	ARM Cortex A53
GPU:	Mali-450
RAM:	2GB
ROM:	16GB
Resolution:	3840 × 2160
Brightness:	450 cd/m <sup>2</sup>
Contrast:	1200:1
Response time:	6 ms
Refreshing Frequency:	60 Hz
Display Area:	1649,66 (H) x 927,94 (V) mm (64.92" H x 36.5" V)
Outline Dimensions:	1736,8 x 1035,3x 108 mm (68.38" x 40.75" x 4.25")
Package Dimensions:	1990 x 1165 x 320 mm (78.35" x 45.87" x 12.6")
Net / Gross weight:	61,15 / 87,7 kg (134.8 / 193.3 lb)

### 3. Safety Warning

Before using the device, please read the instructions carefully.

#### Placement

- Do not put the device on surfaces that are unstable, easy to tilt or which can fall.
- Do not put the device in places with direct sunlight, or near sources of heat, such as electric heaters or bright light sources.
- Do not use the device next to radiation emitting equipment.
- Do not put the device in damp places or places where it might be exposed to moisture or liquids.
- Do not insert any items inside of the device.
- Do not place heavy objects on the device.

#### Power Supply

- Please verify compatibility between the voltage value on back shell nameplate and the main power supply voltage value.
- In case of thunderstorm and lightning weather, please unplug power cord and antenna plug.
- When no one is indoors or the device will not be in use for an extended period of time, please unplug the power cord.
- Please protect the power cord from physical or mechanical damage.
- Please use the special power cord, and do not modify or extend the power cord.
- Please check and make sure the AC power ground wire is connected.

#### Screen

- When writing on screen, please do not use hard or sharp objects instead of styluses.
- When the screen requires cleaning, please unplug the power cord first.
- Please use a soft, dust-free, dry cloth to wipe the screen.
- Do not use water or a spray cleaner to clean the device.
- Please contact the service center for internal cleaning of the device.
- Do not display image with high brightness on the screen for a long time.

#### Range of Visibility

- The best distance between eyes of viewer and screen is 5 to 7 times of the screen diagonal.
- The best viewing angle between eyes of viewer and listener and screen is within 178 degrees up and down, left and right.

#### Temperature

- Do not place the device near an electric radiator or heating unit.
- When moving the device from a low temperature area to a high temperature area, before connecting the device to power, please leave the device idle in the new environment for some time to allow for temperature adjustment, in order to sufficiently diffuse internal condensation prior to powering on.
- The Device's normal working temperature is 0~40°C, storage temperature is -10~60°C

#### Humidity

- Do not expose the machine to rain, moisture, or places near water.
- Please make sure the indoor environment is dry and cool, the machine's normal working humidity is 20 - 80% RH, storage humidity is 10~60% RH.

**Ventilation**

- Please place the machine in ventilated places, and ensure machine's good heat dissipation.
- Please ensure ventilation spaces 10 cm (4 inches) on the sides and back, and 30 cm on the top of the machine.

**Headphones**

- Extended use of headphones at high volumes may damage hearing. If external headphones/earbuds are needed, please turn down the machine volume in advance.

**Standby**

- The standby button on the front of device body will not completely shut off the device, but only place the device in standby mode.

**Battery**

- Please dispose of used batteries in the proper manner and recycle.
- To avoid danger, please do not let children touch the battery, and do not put the battery into water.

**Caution**

- This product is a Level 4 product, and may cause radio interference in the living environment. In this case, the user may be required to take practical measures to mitigate the effects.

**Notes for Cleaning**

- There are vents on back cover, please do not use any liquid on or spray this area directly during cleaning.

**Power Switch Status Signs**

- "I" means power on, "O" means power off.

**Notes for Maintenance**

- This machine can only be maintained by certified engineer.



### 4. Preparing for Installation

#### Unpacking

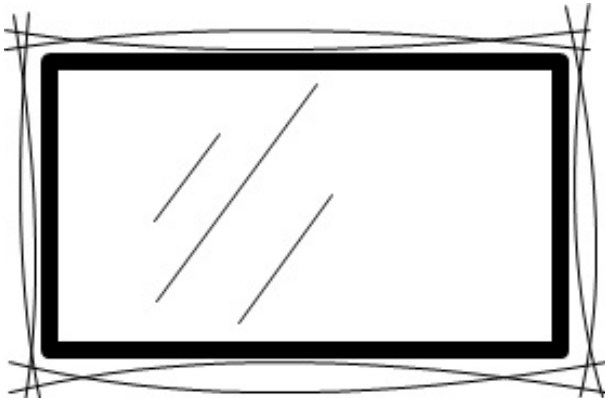

#### Accessories

Quick start guide, styluses, cleaning pads, remote control, power cables (UK, US, EU), VGA cable, touch USB cable, headphone cable, AV cable, USB Flash Drive and VC Camera Bracket.



User manual



2x Stylus



Cleaning Pads



Remote control



Power cable (US, UK, EU)



VGA Cable



USB Cable



Headphone Cable



AV Cable



USB Flash Drive



HDMI Cable

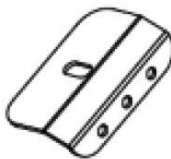

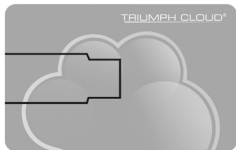

VC Camera Bracket

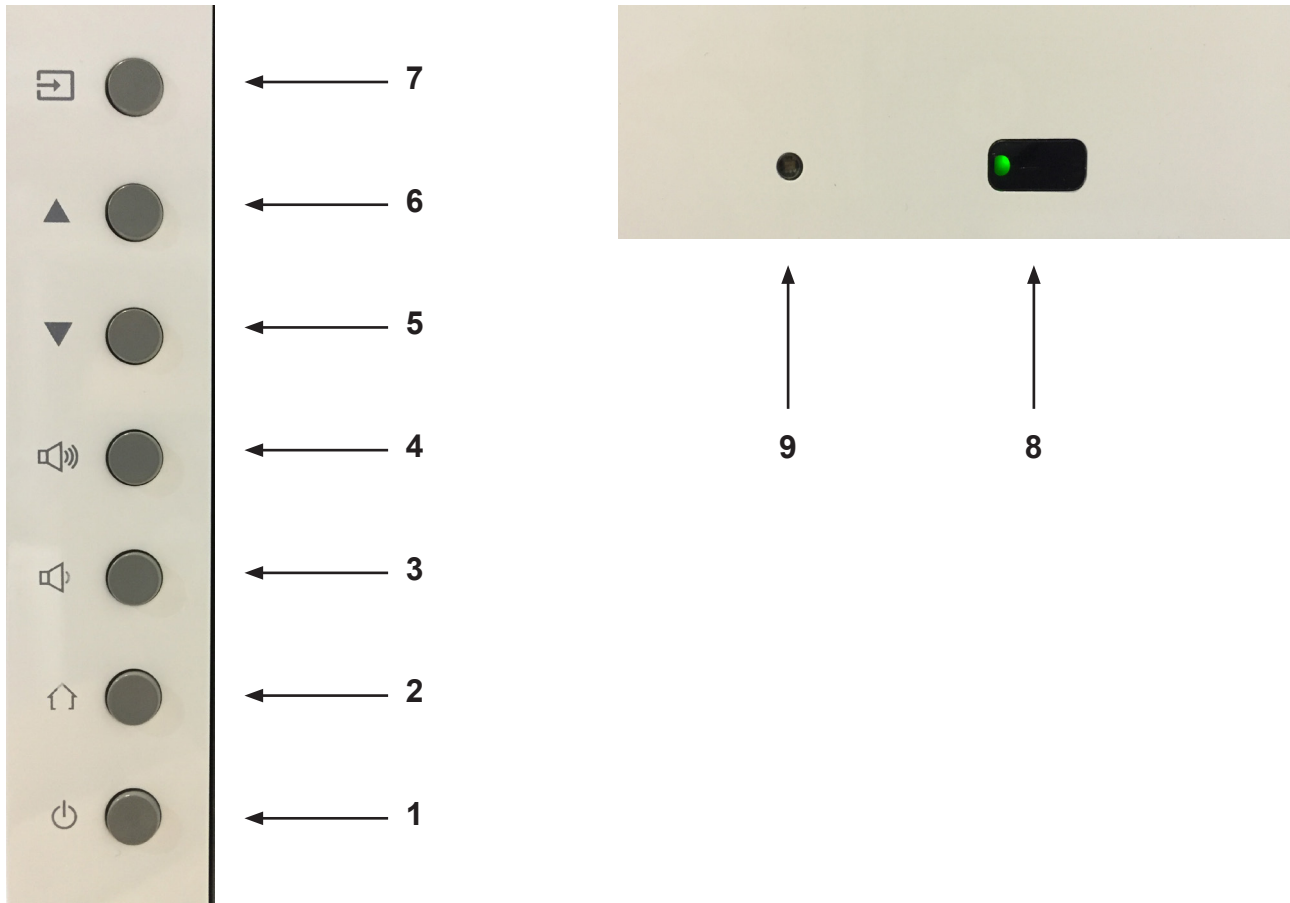

TCloud USB drive

## Control Panel



Number	Item	Function Description
1		Power On/Off
2	SETTINGS MENU	Settings menu button: Settings OSD menu
3	VOL -	Volume down button: turn volume down
4	VOL +	Volume up button: turn volume up
5	▲	Adjustment button: move up (OSD menu)
6	▼	Adjustment button: move down (OSD menu)
7	TOUCH ON/OFF	Touch function button: Enable/Disable touch function
8	POWER INDICATOR	Led indicator color shows the status of power On/Off On - green / Standby mode (Off) - red
9	REMOTE CONTROL SIGNAL RECEIVER	Receive the remote-control signal

5. IFP Interface Inputs, Outputs

left bottom side of IFP

right side of IFP

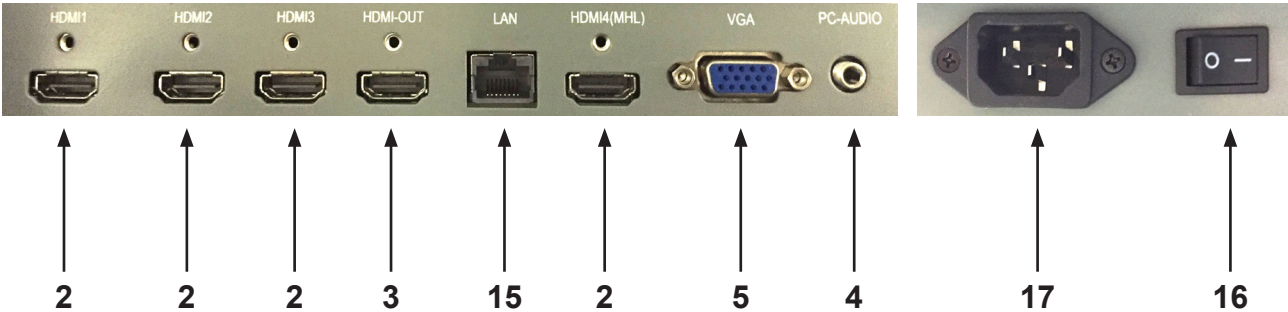

left bottom side of IFP

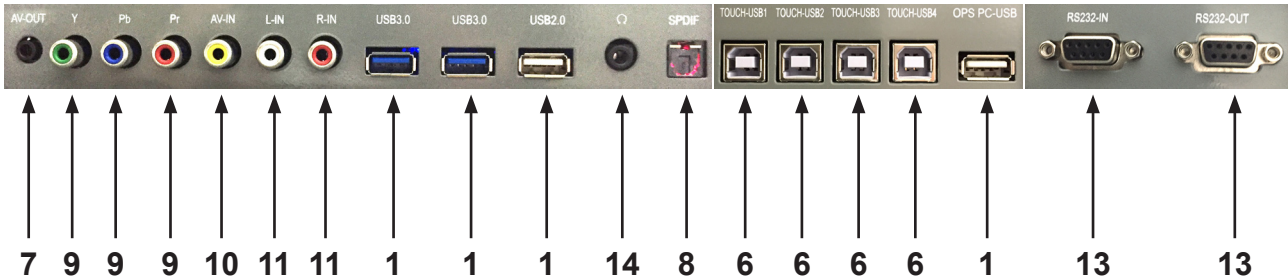

front panel

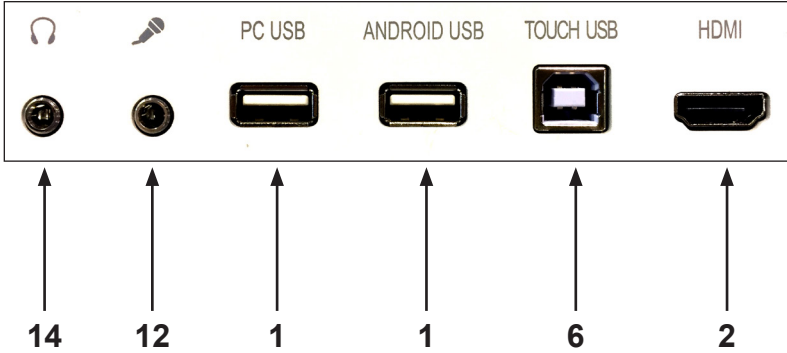















<b>Ports</b>	<b>Description of Function</b>
<b>1. USB 2.0 USB 3.0 PC USB ANDROID USB</b>	Connect USB devices such as portable hard drives, USB drives, USB keyboard and mouse, etc.
<b>2. HDMI IN</b>	High-definition multimedia interface signal input, for connecting to PC (personal computer) with HDMI output, set-top box, or other video device and can also implement touch function.
<b>3. HDMI OUT</b>	Connected to display devices with HDMI input function
<b>4. AUDIO IN</b>	External computer audio input
<b>5. VGA IN</b>	External computer image input
<b>6. TOUCH USB</b>	External computer touch signal input. Default touch function is available under internal computer. When connecting an external computer, in addition to connecting external computer VGA and audio signals, the-external computer's USB port needs to be connected to the equipment. Under the condition that driver is installed, the external computer can be touch controlled through the equipment (touch function is effective in PC, VGA and HDMI channel by default)
<b>7. AV OUT</b>	3,5 mm (0.138") composite video and audio output
<b>8. SPDIF</b>	SPDIF Out- digital optical audio output
<b>9. YPbPr</b>	YPbPr In- component video input
<b>10. AV IN</b>	Audio/video- Cinch audio/video input
<b>11. L IN/R IN</b>	L In/R In- Cinch L/R audio input
<b>12. MIC IN</b>	3,5mm (0.138") Microphone input
<b>13. RS232 IN/OUT</b>	Serial interface, used for mutual transfer of data between devices
<b>14. Audio Out</b>	3,5 mm (0.138") connector Audio Out
<b>15. LAN</b>	LAN interface, connecting RJ45 terminals. (This network port is only used for Android system)
<b>16. POWER SWITCH</b>	Main power switch ON/OFF
<b>17. AC IN</b>	AC power input, connecting AC power supply

### 6. Remote Control

Remote control button instructions



Key		Descript
POWER		Switch between normal operation and standby
SCREENSHOT		Take screenshot
MUTE		Enable or disable sound
LETTER/NUMERIC KEYS		Input any letters and number
F1 FRZ (FREEZE)		Enable or disable freeze function in the system
CH LIST		Allow backspace when inputting characters / view TV channel list
HOME		Display the home page of the product
MENU		Display the main Settings menu
CURSOR KEYS	( t / u / ▲ / ▼ )	Select or adjust menu options
VOL	+ / -	Adjust volume
BACK		Return to the previous settings interface
SOURCE		Display the source selection menu (valid only in TV mode)
CH	+ / -	Turn channels up/down
AUDIO		Select the sound mode of the product
SLEEP		Set the sleep time and auto standby when the specified time is reached
INFO		Display channel info of the product
ZOOM		Switch the channel display ratio on the screen
IMAGE		Select the picture mode of the product
SYSTEM		Only for switching TV systems
STEREO		Select the NICAM mode of the product
OK (OK)		Confirm the operation
PLAY		For operation of multimedia functions in Android
PAUSE		
STOP		
ROTATE		
PREV		
NEXT		
BACK		
SPEED		

## Remote Control Use Instructions

### Install Batteries (batteries not included)

- 1) Open back cover of battery compartment on the back of remote control
- 2) Install AAA type batteries according to the corresponding electrode, make sure battery positive and negative poles are correctly placed („+“to“+“, „-“ to „-“), please do not mix old and new batteries
- 3) After batteries are installed, close the back cover of battery compartment, and snap the clip fastener shut against the bottom of the remote.

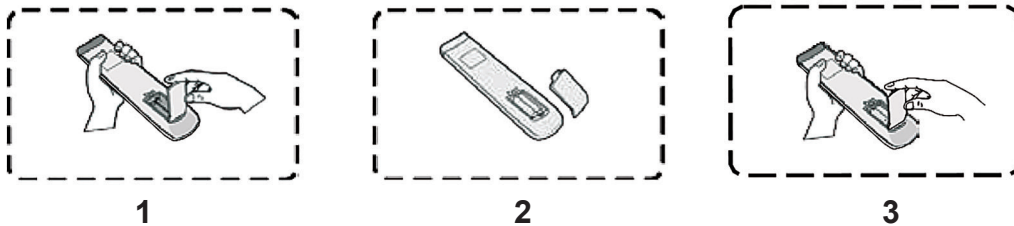

### Range of remote control

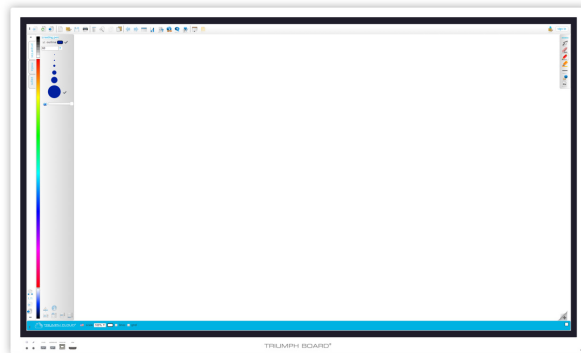

Remote control can function normally within the range of 8 meters' distance, 30 degrees left and right from the remote-control receiver; to protect the environment, please dispose of waste batteries in a designated recycling box.

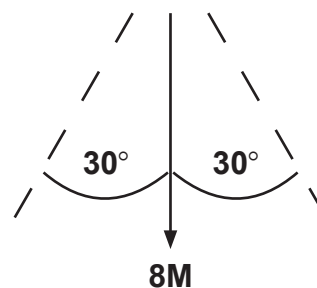

**CAUTION**  
RISK OF EXPLOSION IF BATTERY IS REPLACED WITH AN INCORRECT TYPE  
DISPOSE OF USED BATTERIES ACCORDING TO THE INSTRUCTIONS

## 7. Connection and Set Up

### CAUTION

For the safety of you and the device, please do not connect any power cord before the external device has been prepared.

### External Computer and Touch Connection

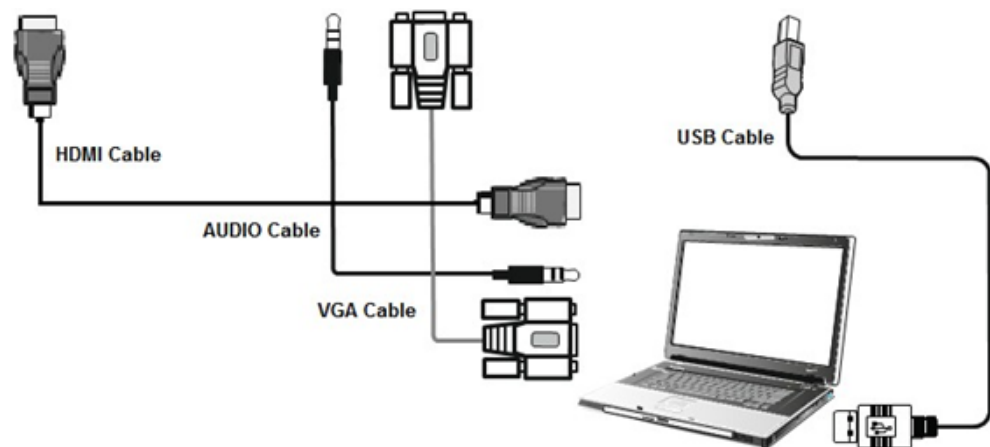
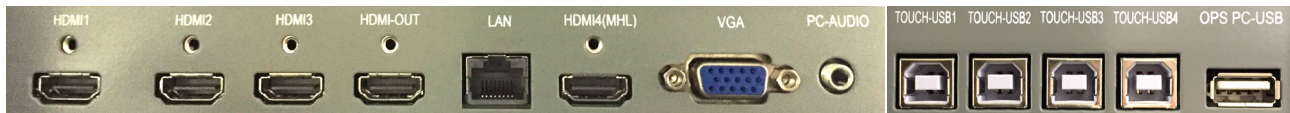

- 1) Use VGA line to connect to VGA output port of external computer, and meanwhile use headphone audio line to connect to external computer audio output interface.
- 2) Use USB line to connect to external computer USB port.
- 3) After connection is completed, plug in power cord, and switch POWER to on.
- 4) Start external computer.
- 5) Press key, and the equipment is powered on.
- 6) Press the INPUT key to switch to VGA channel.

### NOTE:

External computer output, equipment's best resolution is 3840x2160.

External computer can also connect to the equipment through the HDMI cable



## HDMI /HDMI1 / HDMI2 / HDMI3 /HDMI4

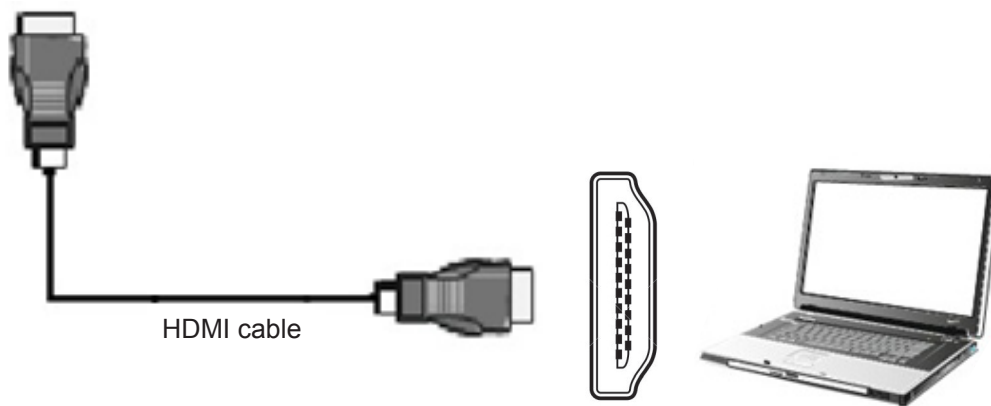
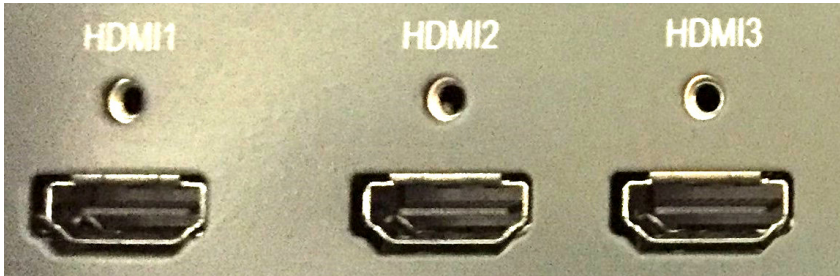

- 1) Use HDMI line to connect audio and video equipment with HDMI output
- 2) After line connection, plug in power cord, and switch power On
- 3) Press  to turn equipment ON
- 4) Press INPUT key to switch to HDMI port

## RS232 Serial port connection

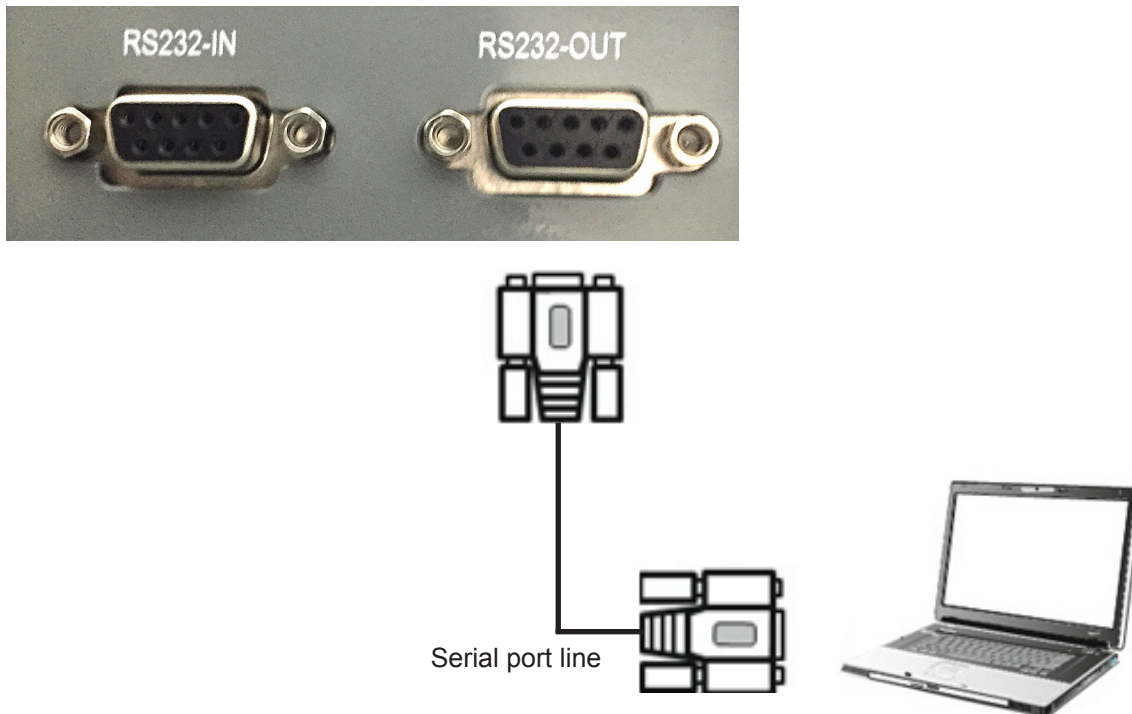

After using the serial port line to connect central control equipment and the device, certain functions of the device can be controlled via the central control device, such as: device ON/OFF, and adjustment of sound volume, etc.

## Wi-Fi USB Adapter



This Wi-Fi USB Adapter is intended only for use in the Android mode. The adapter is designed to be plugged into the following ports: Android USB port, USB 2.0. Wi-Fi USB adapter is included in the package with IFP accessories.

## VESA mount adapter for 86" IFP (designed for 86" IFP only)

VESA mount adapter is part of the standard IFP package.



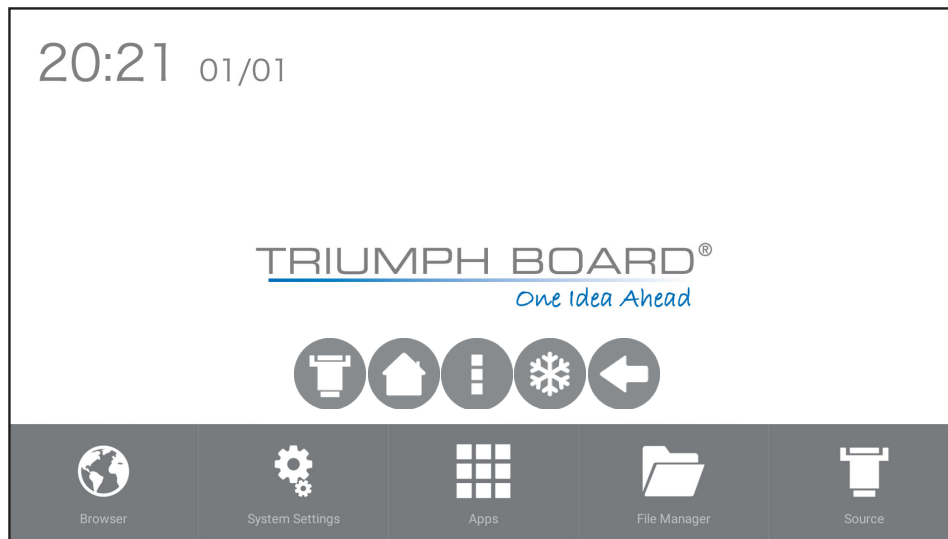

## 8. Android System

### Call up Annotation menu





Take middle point position on the bottom of display screen as the starting point, use finger or stylus to drag towards screen center position to call up touch menu, as shown below.







### Main annotation menu

-  Source (Inputs)
-  Home (return to main window)
-  Submenu
-  Freeze
-  Step back

### Annotation submenu

-  Screenshot
-  Whiteboard (drawing)
-  System Settings
-  File Manager
-  Volume Control

### Inputs

-  VGA input
-  A/V input
-  Component input
-  OPS PC input
-  HDMI input

## 9. Android System

### Main window

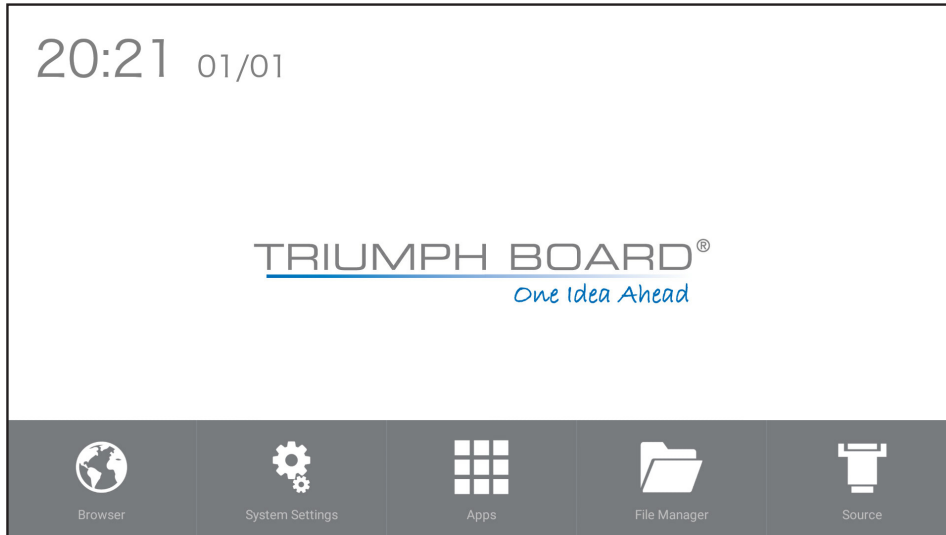

### File Manager

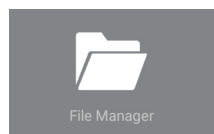

Display files in Android system memory and Android system external storage

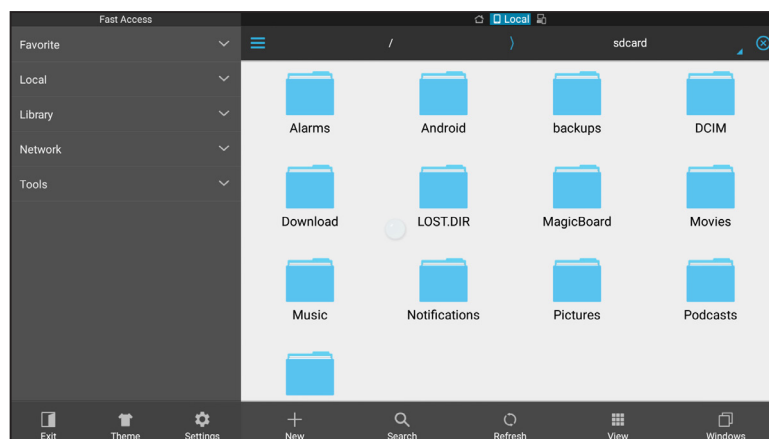

Browser

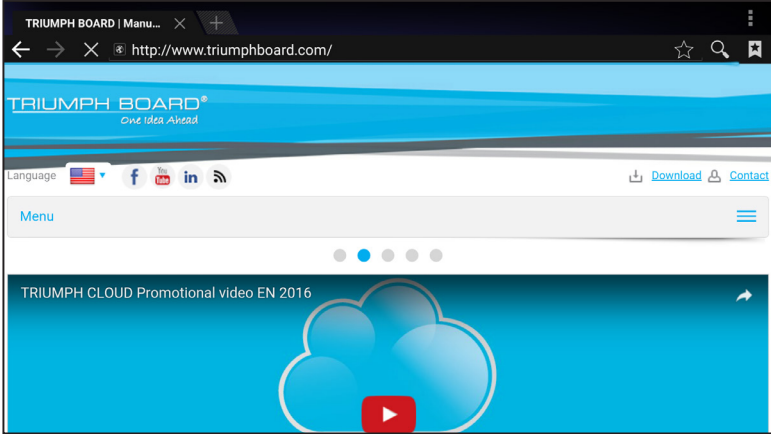
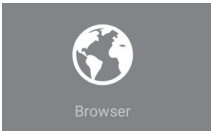

System Settings

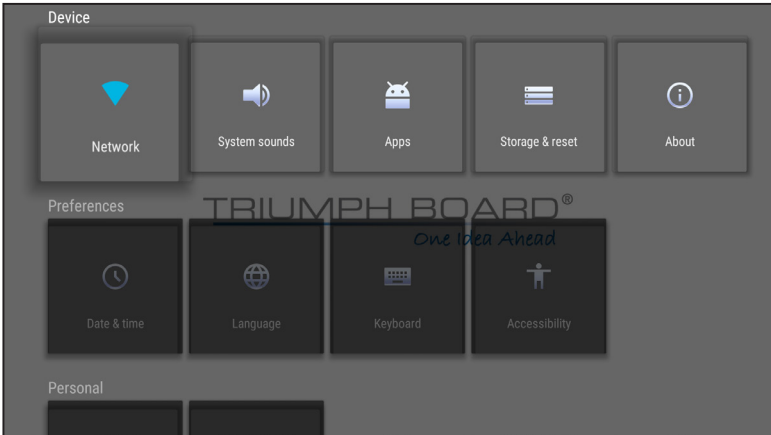

Apps

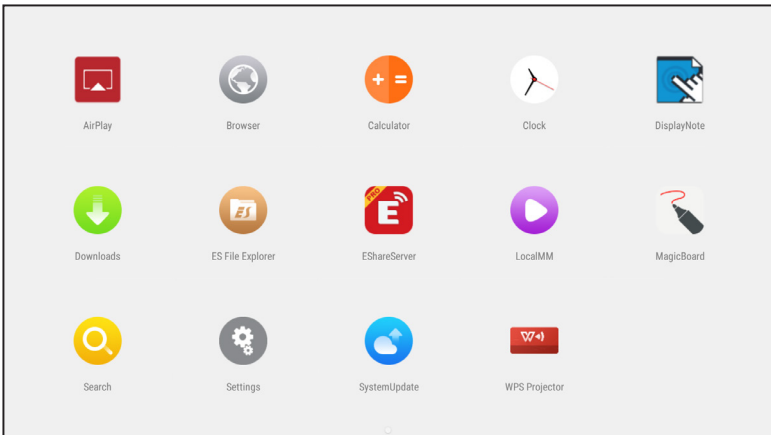
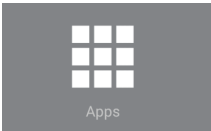

## 10. Troubleshooting

### Board fails to work normally

<b>Remote control failure</b>	<ol style="list-style-type: none"> <li>1. Check whether there are other objects between remote control and television remote control receiving window, blocking signal transmission and thus leading to failure of remote control.</li> <li>2. Check whether the battery terminal in the remote control is correctly connected.</li> <li>3. Check whether remote control needs battery replacement.</li> </ol>
<b>Device automatically shuts down</b>	<ol style="list-style-type: none"> <li>1. Check whether the sleep function is set or not.</li> <li>2. Check whether there has been a sudden power outage.</li> <li>3. Check whether there is no signal automatic shutdown.</li> </ol>

### PC mode

Signal out of range	<ol style="list-style-type: none"> <li>1. Check whether display is set correctly.</li> <li>2. Check whether resolution is the best resolution.</li> <li>3. Adjust line and field synchronization in menu.</li> </ol>
Background has vertical lines or streaks	<ol style="list-style-type: none"> <li>1. Select automatic correction in menu.</li> <li>2. Adjust clock and phase position in menu.</li> </ol>
Image lack of color, color is incorrect	<ol style="list-style-type: none"> <li>1. Check whether VGA is not securely connected or has a quality problem.</li> <li>2. Adjust color and brightness or contrast in menu.</li> </ol>
Display format that is not supported	<ol style="list-style-type: none"> <li>1. Select automatic correction in menu.</li> <li>2. Adjust clock and phase position in menu.</li> </ol>

### Touch Function

Touch function invalid	<ol style="list-style-type: none"> <li>1. Check whether touch driver is installed and started.</li> <li>2. Check whether the size of article touched is comparable with finger.</li> </ol>
Touch positioning not correct	<ol style="list-style-type: none"> <li>1. Check whether driver is properly installed and make correction.</li> <li>2. Check whether touch using finger or stylus is facing the screen.</li> </ol>

### Video Malfunctions

No picture and no sound	<ol style="list-style-type: none"> <li>1. Check whether the device is in active mode.</li> <li>2. Check whether the signal wire is plugged in securely, using the corresponding INPUT.</li> <li>3. If in internal computer mode, check whether internal computer is running.</li> </ol>
With horizontal or vertical stripes or image distortion	<ol style="list-style-type: none"> <li>1. Check whether signal wire is securely connected.</li> <li>2. Check whether other electronic equipment or power tools are placed around the device.</li> </ol>
No color, color is weak or image is weak	<ol style="list-style-type: none"> <li>1. Adjust color and brightness or contrast in menu.</li> <li>2. Check whether signal wire is securely connected.</li> </ol>

### Audio Malfunctions

Image but no sound	<ol style="list-style-type: none"> <li>1. Check whether mute button is pressed for mute.</li> <li>2. Press VOL. + / - to adjust volume.</li> <li>3. Check whether audio line is connected correctly.</li> </ol>
Only one speaker has sound	<ol style="list-style-type: none"> <li>1. Adjust sound balance in menu.</li> <li>2. Check whether computer sound control panel only sets up one sound channel.</li> <li>3. Check whether audio line is connected correctly.</li> </ol>
VGA output without sound	<ol style="list-style-type: none"> <li>1. Check whether an external device is connected with headphone cable.</li> </ol>

## 11. Maintenance

Proper maintenance can prevent many early defects. Regular, careful cleaning can keep the device like brand- new.

Please unplug power plug before cleaning and maintenance, to prevent electric shock.

### Clean screen

Mix a small amount of fabric softener or dishwashing detergent with warm water. Dip a soft cloth into the mixture, and then wring to a semi-dry state. Use this to wipe the screen of the device. Repeat several times, being careful not to squeeze any liquid into the device when wiping the device.

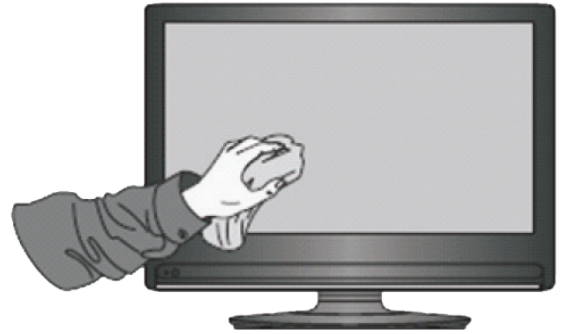

### Clean front frame

Please use dry, soft, lint-free cloth to wipe front frame.

### Device to remain unused for extended period

If the device will not be used for an extended period of time, such as during a vacation, please make sure to unplug the cord to prevent any possible dangers caused by power surges from lightning.



For cleaning glass surface of your IFP, we recommended to use TRIUMPH Cleaning Pads  
EAN:8592580083365.



## 12. Repair Service and Contacts

Please contact your local supplier regarding warranty and technical service. You can find all warranty conditions and service partners on our website [www.triumphboard.com/support/warranty](http://www.triumphboard.com/support/warranty). If you have any questions please email us at [info@triumphboard.com](mailto:info@triumphboard.com)

**TRIUMPH BOARD a.s.**

**Neklanova 122/15**

**128 00 Prague 2**

**Czech Republic**

**EU**

**Phone: +420 224 910 221**

**Fax: +420 224 910 218**

**E-mail: [info@triumphboard.com](mailto:info@triumphboard.com) [www.triumphboard.com](http://www.triumphboard.com)**

### **Notices**

Every effort has been made to ensure all information contained in this user guide is correct, but the accuracy or completeness is not guaranteed. Before using this product, you must evaluate it and determine if it is suitable for your intended application. You assume all risks and liability associated with such use. Any statements related to this product not contained in this manual or any contrary statements appearing on your purchase order shall have no force of effect unless expressly agreed upon, in writing, with this company.

Reproduction or reprinting of this user guide or any part without permission is prohibited.

The content of this user manual is subject to change without prior notice.