



# TRIUMPH BOARD

## Videoconferencing System VC1

User's Manual

## CONTENTS

<b>INTRODUCTION</b> .....	<b>1</b>
Features .....	1
Package Contents .....	2
<b>INSTALLATION</b> .....	<b>3</b>
Getting Familiar with the TRIUMPH BOARD Video Conferencing System VC1 .....	3
MAIN SYSTEM .....	3
MIC .....	4
CAMERA .....	5
REMOTE CONTROLLER .....	6
<b>CONNECTIONS</b> .....	<b>8</b>
CONNECTING MONITORS (VGA OUT/HDMI OUT) .....	9
CONNECTING THE CAMERA (CAMERA IN) .....	9
CONNECTING THE MIC (MIC IN) .....	10
CONNECTING THE LAN (RJ-45) .....	10
CONNECTING THE POWER (DC 12V) .....	11
CONNECTING PC (VGA IN) .....	11
CONNECTING THE AUDIO (AUDIO IN/OUT) .....	12
USB STORAGE (USB PORTS) .....	13
<b>BEFORE INSTALLATION</b> .....	<b>13</b>
Using the Camera .....	13
Infrared Sensor (IR) .....	13
Positioning the MIC .....	14
<b>TRIUMPH BOARD VIDEO CONFERENCING SYSTEM VC1 WIZARD SETUP</b> .....	<b>15</b>
START .....	15
LANGUAGE .....	15
SITE NAME .....	16
NETWORK SETTING .....	16
PUBLIC IP CONFIGURATION (OUTSIDE OF FIREWALL): .....	16
PRIVATE IP CONFIGURATION (BEHIND FIREWALL PORT FORWARDING): .....	19
SIP SETTING .....	21
SIP SERVER REGISTRATION .....	21
DATE AND TIME SETTING .....	22
NETWORK TIME PROTOCOL (NTP) .....	22
MANUALLY SETTING .....	22
<b>TRIUMPH BOARD VIDEO CONFERENCING SYSTEM VC1 OPERATION</b> .....	<b>23</b>
Before You Begin .....	23
Home Screen .....	23

CONFIGURATION ICONS.....	23
COMERA AND MIC ICONS.....	24
WAN ADDRESS.....	24
REAL-TIME CLOCK.....	24
Dial.....	25
Phonebook.....	27
GROUP.....	27
NEW SITE (CONTACT IN PHONEBOOK).....	32
CONTACTS LIST.....	35
Call History.....	36
General Setting.....	38
SYSTEM INFO.....	38
CALL SETTINGS.....	38
SYSTEM SETTINGS.....	40
ADMINISTRATOR.....	41
DATE AND TIME.....	45
RESET SYSTEM.....	47
Video/Audio.....	48
CAMERA.....	48
MICROPHONE.....	50
VIDEO/AUDIO CODECS.....	51
Network.....	52
LAN CONFIGURATION.....	52
LAN CONFIGURATION (IPV6).....	54
FIREWALL.....	56
SIP.....	57
SIP SERVER.....	60
GATEKEEPER.....	63
<b>WEB CONFIGURATIONS.....</b>	<b>65</b>
Using the WebTool.....	65
Managing Phonebook.....	67
EDIT AND SAVE.....	67
DOWNLOAD PHONEBOOK ENTRIES.....	68
UPLOAD PHONEBOOK ENTRIES.....	68
Update System.....	69
<b>MAKING A CALL.....</b>	<b>70</b>
Using the Phonebook.....	70
Using Dial.....	71
Using Call History.....	72

SCENARIOS FOR LAN CONNECTION .....	73
Public IP Configuration (Outside of Firewall) .....	73
Private IP Configuration (Behind Firewall with Port Forwarding) .....	74
H.460 Gatekeeper with Firewall Traversal.....	76
SPECIFICATIONS.....	78
TROUBLESHOOTING .....	82
Audio.....	82
Video/Display .....	82
Network.....	83
OTHERS .....	84
REMOTE CONTROL BATTERY SAFETY INFORMATION.....	84
LIMITED WARRANTY .....	85
Limitations of Warranty.....	85
Disclaimer of Warranty .....	85
Governing Law and Your Rights.....	86
FEDERAL COMMUNICATIONS COMMISSION STATEMENT .....	86
Class A ITE .....	86
CE Class A (EMC) .....	87
COPYRIGHT .....	87
Trademarks.....	87
Disclaimer .....	87

## Introduction

Thank you for choosing TRIUMPH BOARD Video Conferencing System VC1 which offers professional videoconferencing experience in new cost performance benchmark.

Video Conferencing System VC1 gives you the latest technologies; slim form factor, flexible integration options and backward compatibility to most videoconferencing install bases. It makes any business meetings and special events much more reliable, effective, and secure.

## Features

- ▶ Make point-to-point call to another H.323 or SIP videoconferencing system
- ▶ Support full content sharing experience (send and receive) at 30fps, send content from VGA or IP
- ▶ Dual monitor support via HDMI and VGA
- ▶ Support CIF (352x240) up to Full HD (1920x1080 30fps) video call
- ▶ eCam Focus is 88 degree super wide angle Pan Tilt camera with 2Mp low lux sensor
- ▶ Include one microphone array, much better audio pick up than competitor offering
- ▶ 10/100 and Gigabit Ethernet; video bandwidth from 64Kbps to 4Mbps
- ▶ Support IPv4 / IPv6 and Wake-on-LAN (WOL)
- ▶ User-friendly on screen operation, support up to 20 languages
- ▶ Support Phonebook download, upload and edit
- ▶ Call history lookups of received, placed and missed calls, allow directly saving it to favorite call list
- ▶ Support H.460 Gatekeeper for NAT and firewall traversal
- ▶ G.722.1 wideband support
- ▶ Infrared (IR) remote control has power button; system supports remote API for AV integration
- ▶ Secure communication using AES 128bit encryption

## Package Contents

The following items are included in the package. Please check if each item is available before using.



- |  |   |
|--|---|
| <ul style="list-style-type: none"> <li>1. Main System</li> <li>2. Camera</li> <li>3. Microphone</li> <li>4. Remote Control</li> <li>5. Power Adapter</li> <li>6. Power Cords (US, UK, EU)</li> <li>7. VGA Cable</li> </ul> | <ul style="list-style-type: none"> <li>8. Mini Din 8 pin MIC Cable (5m)</li> <li>9. HDMI Cable</li> <li>10. Camera Cable (3m)</li> <li>11. RJ-45 Cable (3m)</li> <li>12. Warranty Card</li> <li>13. Quick Installation Guide</li> <li>14. AAA Batteries</li> <li>15. White Panel Label</li> </ul> |
|--|---|

## Installation

# Getting Familiar with the TRIUMPH BOARD Video Conferencing System VC1

Video Conferencing System VC1 includes Main System, MIC, Camera and Remote Controller.

### MAIN SYSTEM

Front Panel:



Name	Function
(1) LED Indicator	Show you the status of your LAN connection. 1. <b>Solid Green:</b> LAN connection is successfully 2. <b>Solid Red:</b> LAN connection is fail. 3. <b>Flash Green:</b> Data transmission is processing through the LAN connection.
(2) POWER Button	Press this button to turn on/off main system. Red: power off; Blue: power on
(3) USB Port	Use to connect the USB storage for system log saving and FW upgrade.

Back Panel:



Name	Function
(1) POWER Port	Connect the power supply cord and adapter to the power port located on the back panel. And connect the other end of the power cord to a suitable power outlet.

(2) USB Port	This port is the same as USB Port located on the front panel.
(3) CAMERA IN	Connect the camera to the main system via a camera cable.
(4) VGA OUT port	Connect the VGA cable to the VGA OUT port located on the back panel, and connect the other end of VGA cable to a display device to output video signal. In dual screen configuration, the output screen connected to this port will be set up to secondary screen automatically.
(5) AUDIO OUT port	Use to connect the main system to external speakers or amplifiers for audio signal output.
(6) HDMI OUT port	Connect an HDMI cable from the HDMI monitor to HDMI OUT port located on the back panel. The HDMI interface allows you to transmit both audio and video signals over a single cable (HDMI cable). In dual screen configuration, the output screen connected to this port will be set up to primary screen automatically.
(7) VGA IN port	Connect the VGA cable to the VGA IN port located on the back panel, and connect the other end of VGA cable to a VGA input sources (ex. Document camera, Laptop or Desktop) to input video signal.
(8) AUDIO IN port	Receive audio signal from an external audio source through RCA left and right audio connections.
(9) MIC IN	Receive audio signal from MIC device via a mini din 8 pin MIC cable.
(10) LAN Port	Use the RJ-45 Ethernet cable to connect an IP-based network to the LAN port.

## MIC

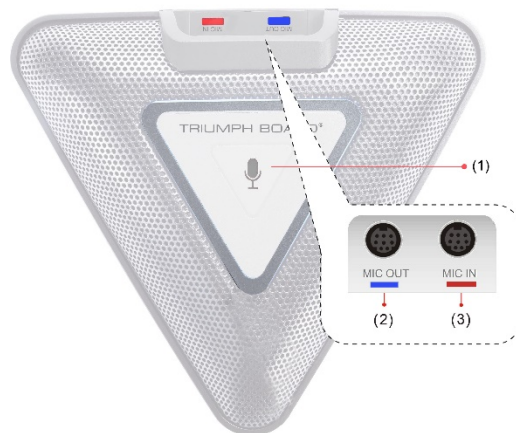

Name	Function
(1) Mute	Mute/Unmute the Mic. Blue: Unmute; Red: Mute
(2) MIC OUT	Outputs audio signal from the MIC to main system.
(3) MIC IN	Receive audio signal from the second MIC and pass it through the MIC OUT to the main system.



## CAMERA

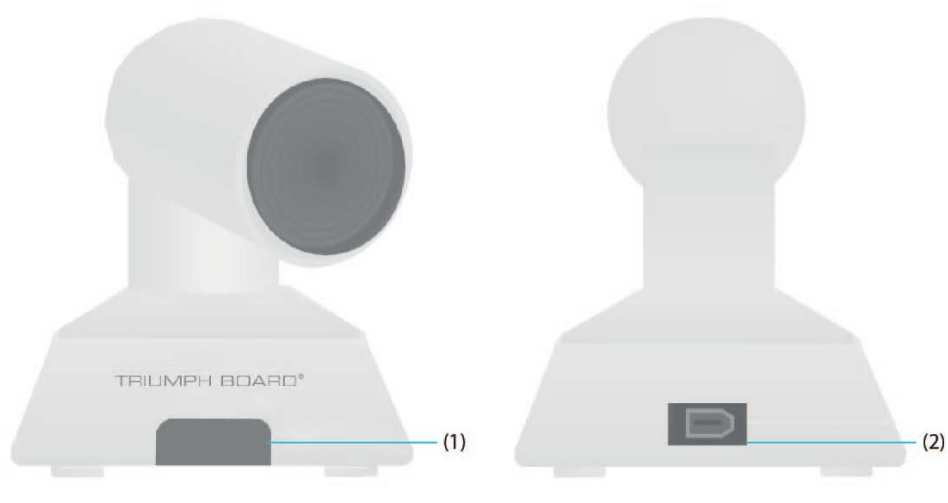

Name	Function
(1) IR Sensor	Receive IR signal from the remote control for system operation. Amber light blinks when it detects key pressing event from remote.
(2) CAMERA OUT port	Connect the camera cable to the CAMERA OUT port located on the back of camera and CAMERA IN port located on the back panel of main system for a video transmission.

## REMOTE CONTROLLER

The remote controller requires two “AAA” batteries (included). Make sure the batteries are installed properly before using the remote controller. Aim the remote controller at the infrared sensor of your Video Conferencing System VC1 camera to remote control the unit.

**Note:** Please press the „VC1“button on the upper right side of your Remote Control in order to control your Video Conferencing System VC1.

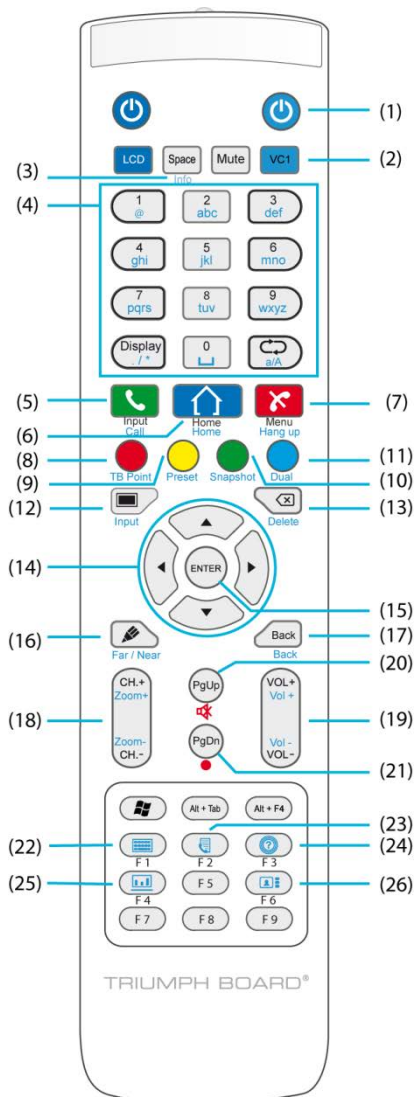

Name	Function
(1) Power	Press this button to power on/off the main system.
(2) VC1	Press this button to control your Video Conferencing System VC1.
(3) Info	Press this button to display the call statistics information.
(4) Numeric Pad	Use to enter numeric numbers.
(5) Call	Start a call.
(6) Home	Bring up the main screen.
(7) Hang up	End the call.
(8) TB Point	Specified for some special functions. For example, on the Phonebook configuration screen of VC1 application, press this button to create a new Group. (TB Point to be developed)
(9) Preset	a. Press and hold for 3 sec. to set the position of the camera to a preset from 0~9. b. Press to move the camera to a selected preset point number.
(10) Snapshot	Capture the image from the camera. To view the captured image, press Present button. (To be developed)
(11) Dual	Switch to dual screen mode. This splits the video conferencing screen and present screen onto two separate monitors (two monitors must be connected to use the feature, one through HDMI and one through VGA).

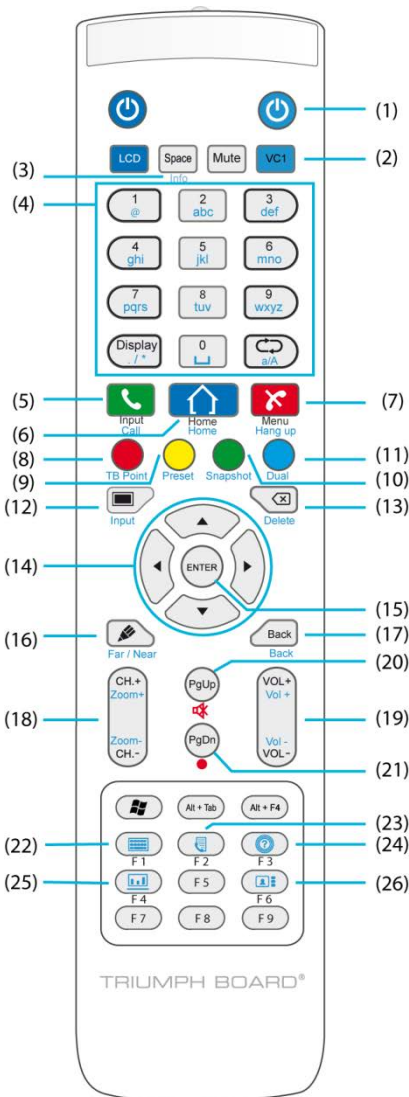

(12) Input	Switch the OSD menu display on VGA or HDMI monitor (dual monitor).
(13) Delete	Press this button to back delete one character at a time.
(14) Navigation Buttons	<ul style="list-style-type: none"> <li>a. Use these buttons to navigate through the selections in OSD menus or on-screen keyboard.</li> <li>b. Pan and tilt the camera to adjust the viewing.</li> <li>c. Pan, tilt the zoomed in camera image or captured image.</li> </ul>
(15) Enter	<ul style="list-style-type: none"> <li>a. Make a selection in OSD menus.</li> <li>b. Accept incoming calls.</li> <li>c. Display the site name and icon during the meeting.</li> </ul>
(16) Far/Near	Select to control either near site or far site camera. The cam ctrl icon will appear on the screen to indicate which site's camera you are controlling. The cam ctrl icon will disappear after press the Far/Near key 5 sec.
(17) Back	Return to previous OSD menu.
(18) Zoom +/-	Increase/decrease the camera zoom or the captured image magnifications.
(19) Vol +/-	Increase/decrease the speaker volume.
(20) Mute	Mute/Unmute the MIC. The mute icon will appear when the MIC is muted. The mute icon will become translucent after enabling 5 sec.
(21) Record	Start/Stop video recording. The video recording can only be saved to a USB flash drive. You do not need to be on a video conference to record.
(22) Keypad	Press this button to display the on-screen keyboard. (To be developed)
(23) Phone Book	<ul style="list-style-type: none"> <li>a. Search contacts to make a call.</li> <li>b. Add, edit, delete or create group contact entries.</li> </ul>

(24) Help

Option function.

---

(25) Presentation

Share the content that comes from either the VGA IN port source or the latest captured image. The present icon will appear on the screen when the presentation function is enabled. The icon will disappear after 5 sec.

---

(26) Layout

Change the screen layout.

---

## Connections

Before making the connections, make sure all devices are powered off. Refer to the illustrated connections below and also to the user manual of the device you are connecting to the TRIUMPH BOARD Video Conferencing System VC1.

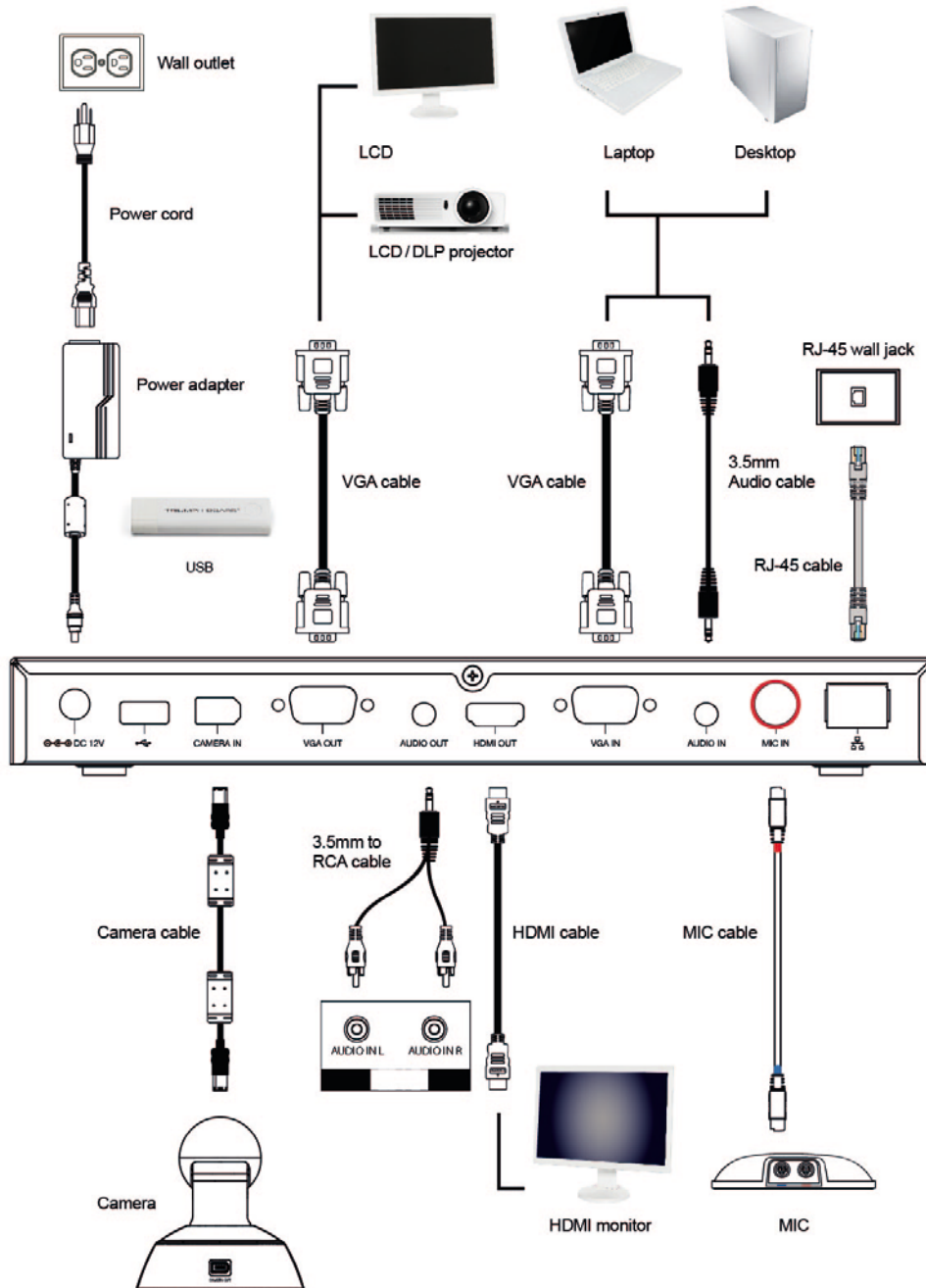

Make sure all connections have been connected successfully before powering on the system.

## CONNECTING MONITORS (VGA OUT/HDMI OUT)

Locate the VGA/HDMI input port of the graphics display device and connect it to VGA OUT/HDMI OUT port of the TRIUMPH BOARD Video Conferencing System VC1 with the supplied VGA/HDMI cable. You can configure the VGA OUT and HDMI OUT ports at the same time upon a dual screen configuration.

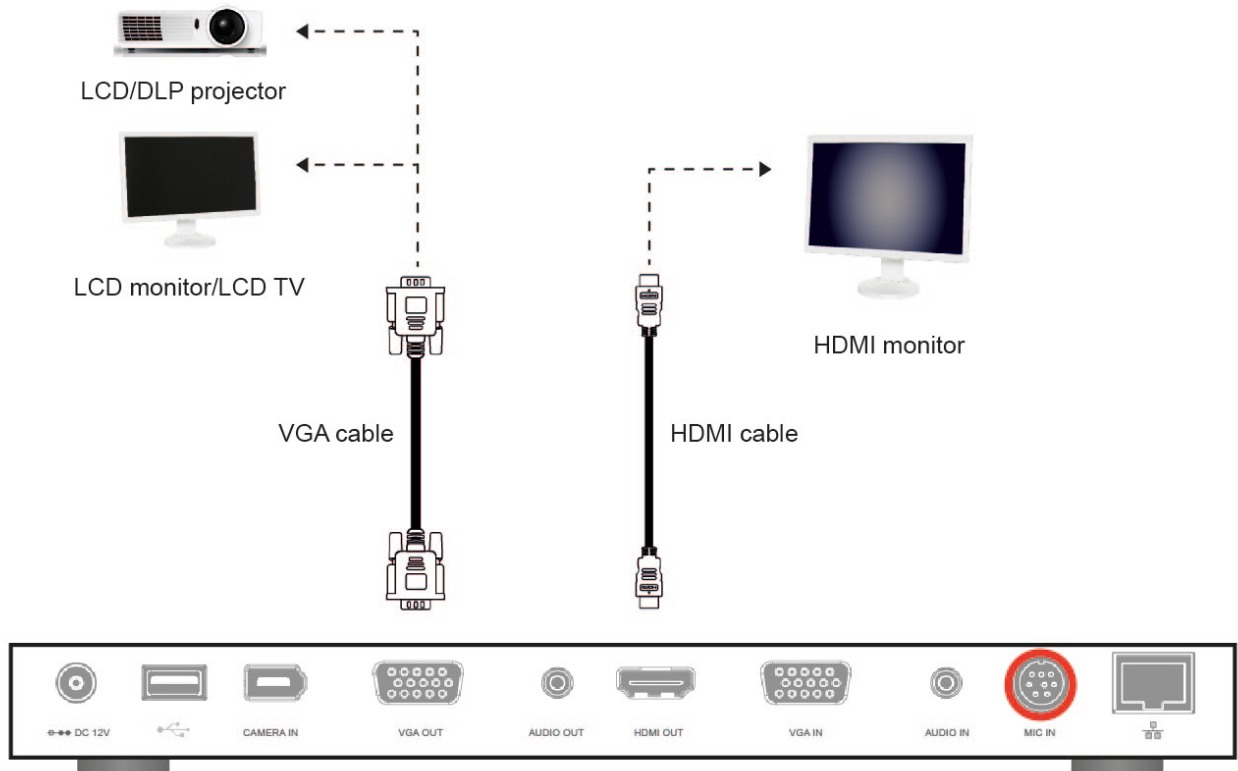

## CONNECTING THE CAMERA (CAMERA IN)

Locate the port on the back of the camera and connect it to the CAMERA IN port of the Video Conferencing System VC1 with the supplied camera cable.

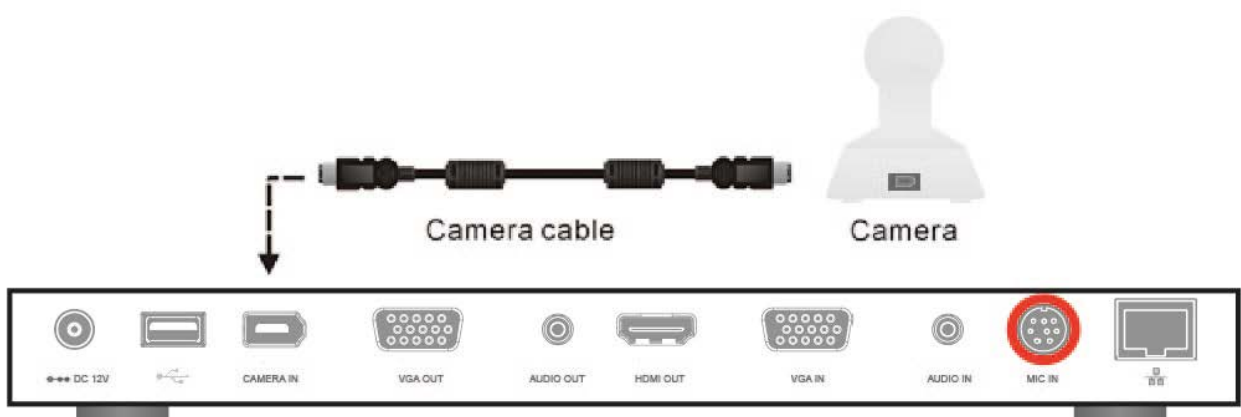

## CONNECTING THE MIC (MIC IN)

Use the supplied MIC cable and connect the red tag connector to the MIC IN port of the Video Conferencing System VC1. Then connect the other end of the MIC cable with the blue tag to MIC OUT port.

☞ Press the button on the top of TRIUMPH BOARD Video Conferencing VC1-MIC to mute/un-mute the MIC.

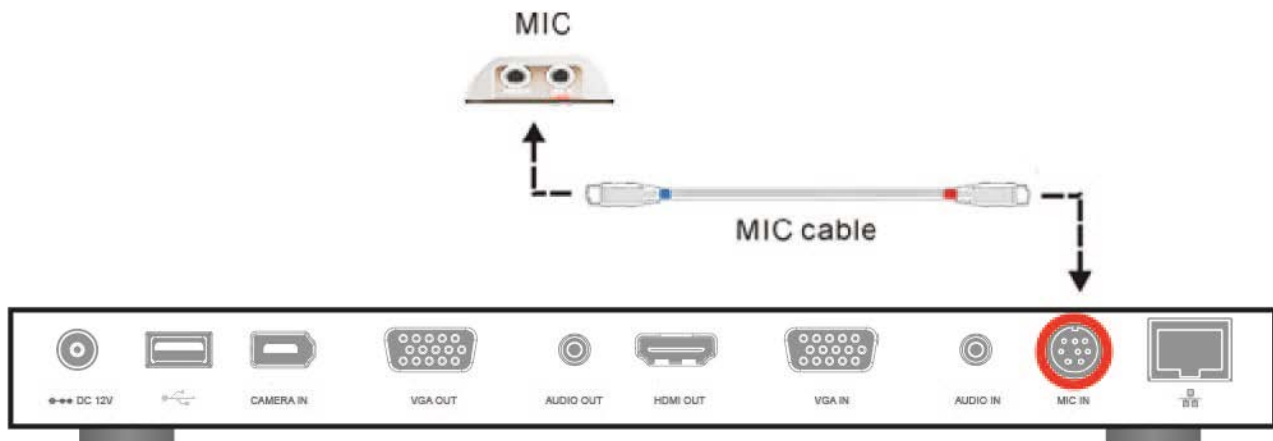

## CONNECTING THE LAN (RJ-45)

Connect the LAN port of TRIUMPH BOARD Video Conferencing VC1 to a RJ-45 wall jack or Ethernet hub with the supplied RJ-45 cable.

☞ It requires an IP-based network before beginning LAN connection.

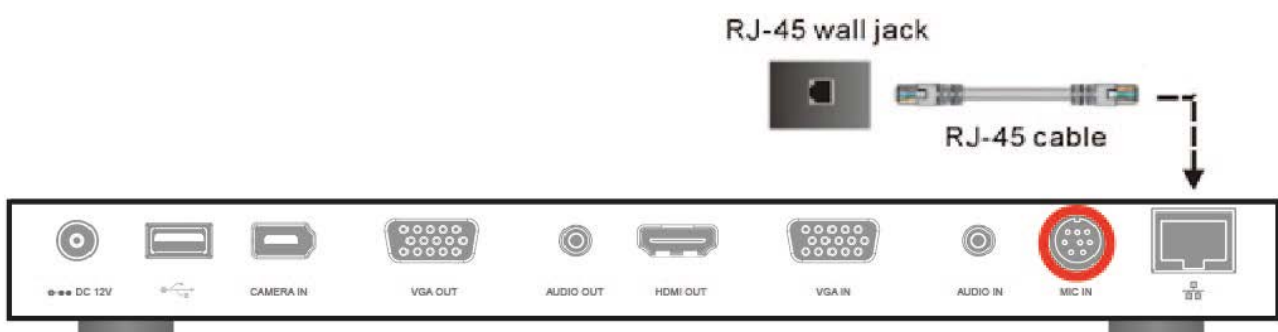

## CONNECTING THE POWER (DC 12V)

Connect the power adapter to a standard 100V~240V AC power outlet with the supplied power adapter and power cord.

- ☞ (1) To prevent shock, make sure all the connections on the main system are connected successfully before connecting the power cable and turning on the power.
- (2) Make sure to use the supplied available power adapter.

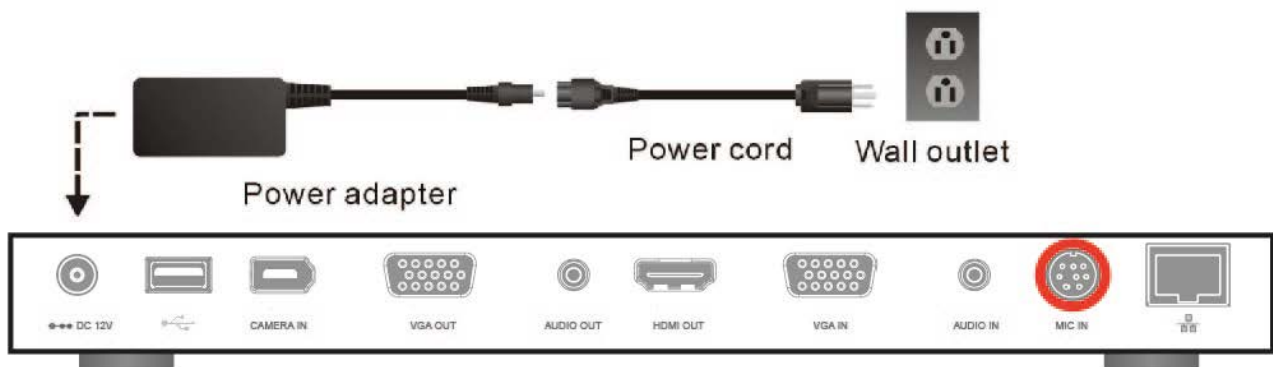

## CONNECTING PC (VGA IN)

Locate the VGA output port of the Laptop or Desktop and connect it to VGA IN port of Video Conferencing System VC1 with the supplied VGA cable for an image display.

- ☞ To share the video signal from the computer, press PRESENT and select “**VGA**”.

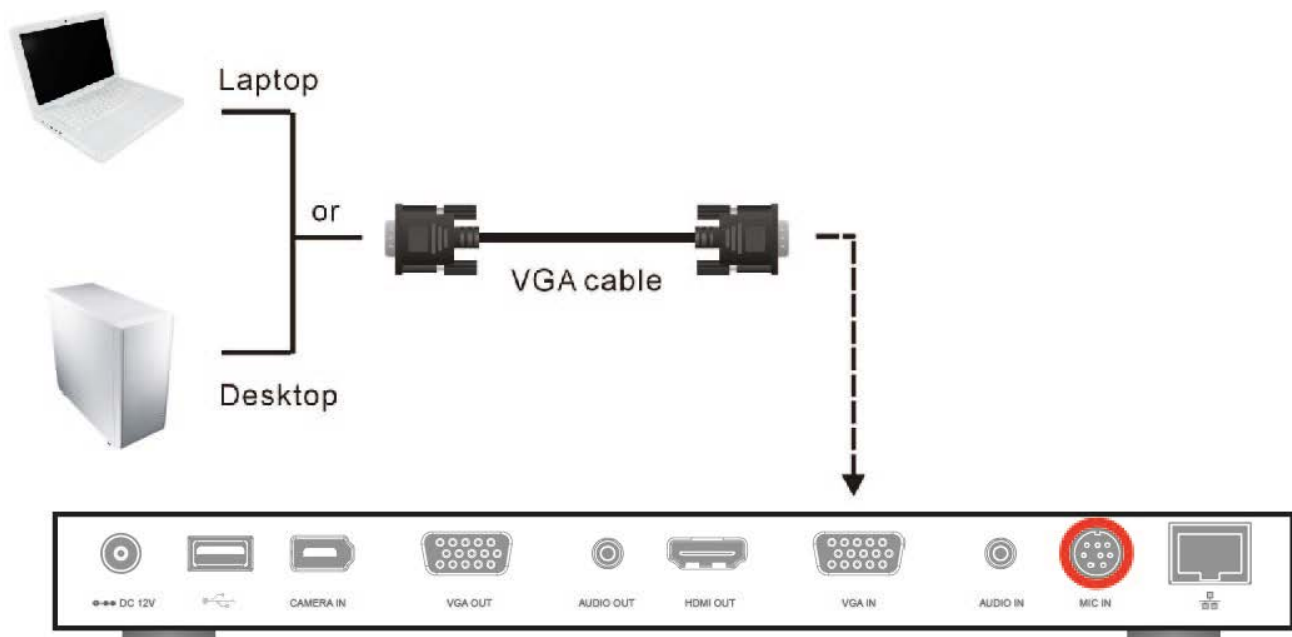



## CONNECTING THE AUDIO (AUDIO IN/OUT)

### AUDIO IN:

Locate the AUDIO output port of the Laptop or Desktop and connect it to AUDIO IN port of TRIUMPH BOARD Video Conferencing System VC1 with the supplied 3.5mm Audio cable.

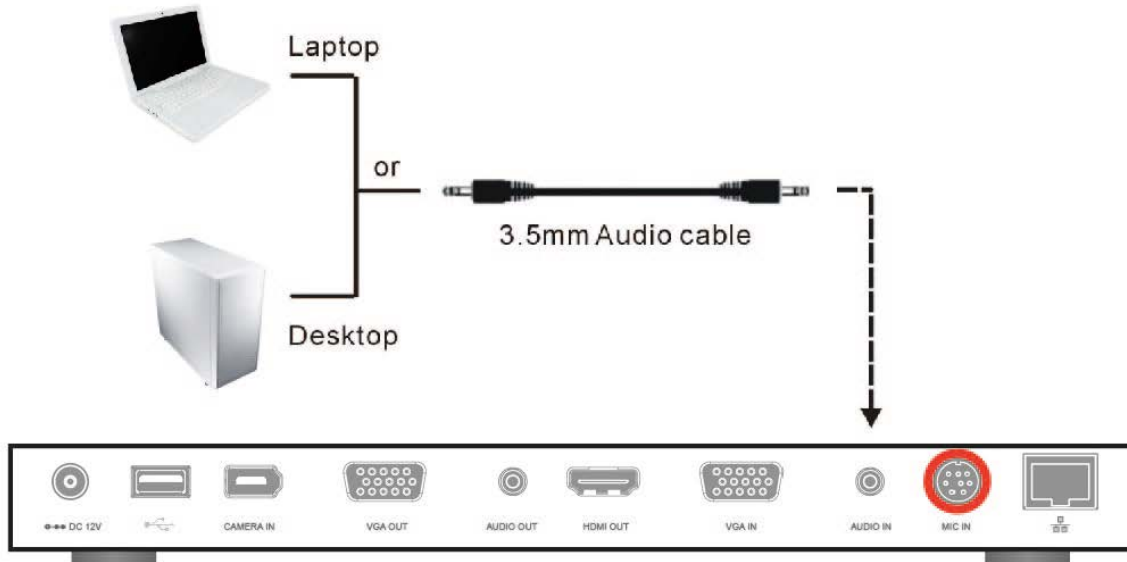

### AUDIO OUT:

Locate the AUDIO in port of the LCD TV speaker or normal speaker and connect them to AUDIO OUT port of TRIUMPH BOARD Video Conferencing System VC1 with a RCA cable.

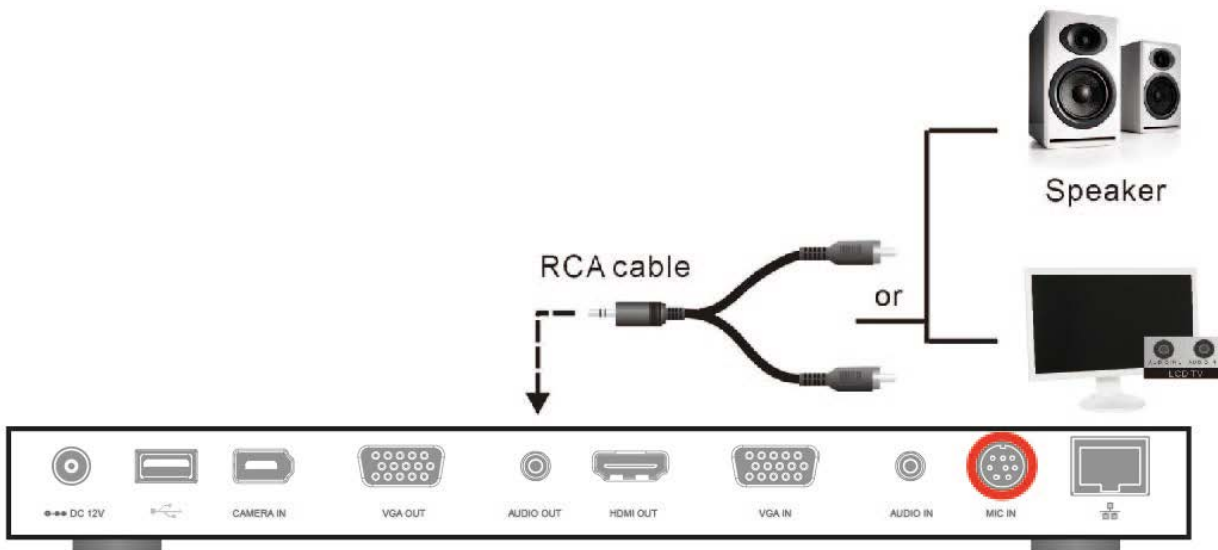

## USB STORAGE (USB PORTS)

Video Conferencing System VC1 main system supports two USB2.0 interface for saving data. One is located on the front panel of main system; another is located on the back panel.

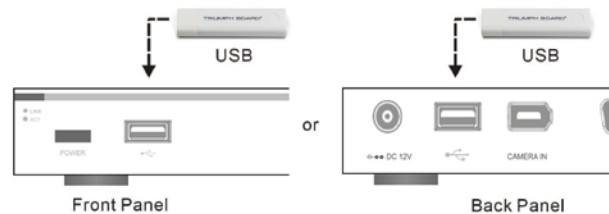

## Before INSTALLATION

This chapter explains the best way to position TRIUMPH BOARD Video Conferencing System VC1 in a conference room.

## Using the Camera

TRIUMPH BOARD Video Conferencing System VC1 includes a detached camera that can pan ( $\varnothing$ +100 deg range), tilt ( $\varnothing$ +25 deg range) and zoom (4X digital) by using the **▲**, **▼**, **◀**, **▶** and zoom +/- buttons on remote controller.

⚠ Avoid physically turn camera while system is powered on to prevent permanent damaging the motors and gears and void the warranty. Always use the remote control to pan and tilt the camera head.

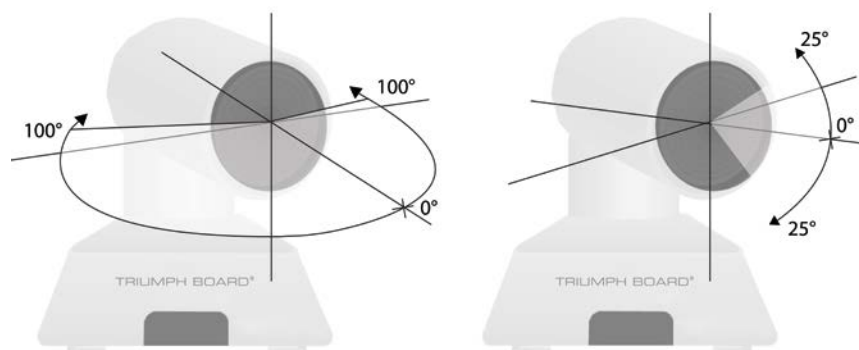

## Infrared Sensor (IR)

Aim the remote controller at the camera infrared sensor to operate the unit.

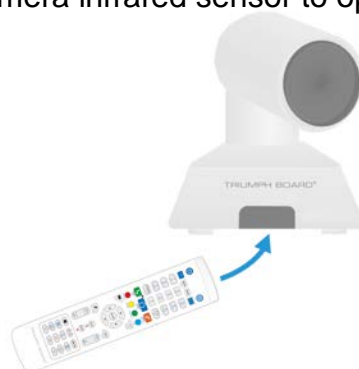

## Positioning the MIC

The best distance for Video Conferencing System VC1-MIC to receive audio signal is within 3m.

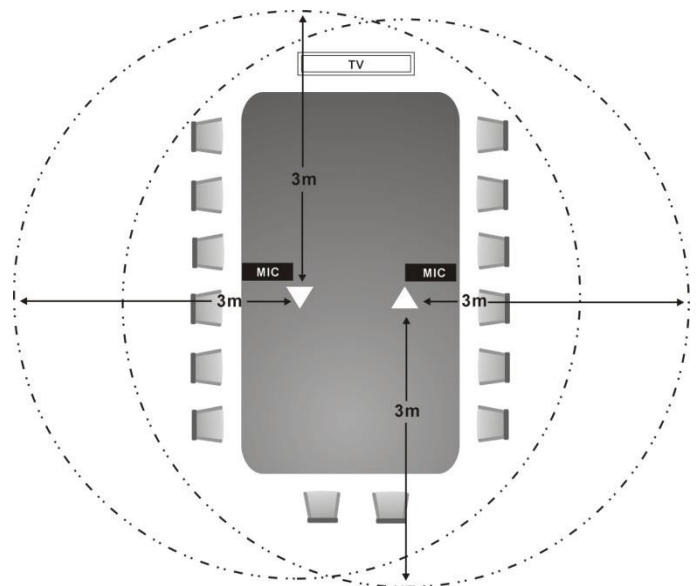
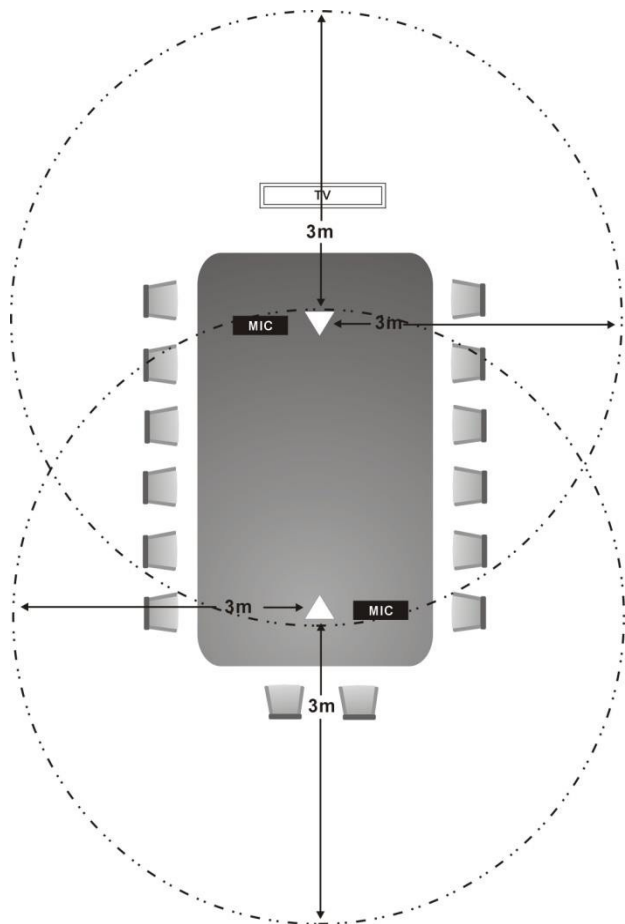
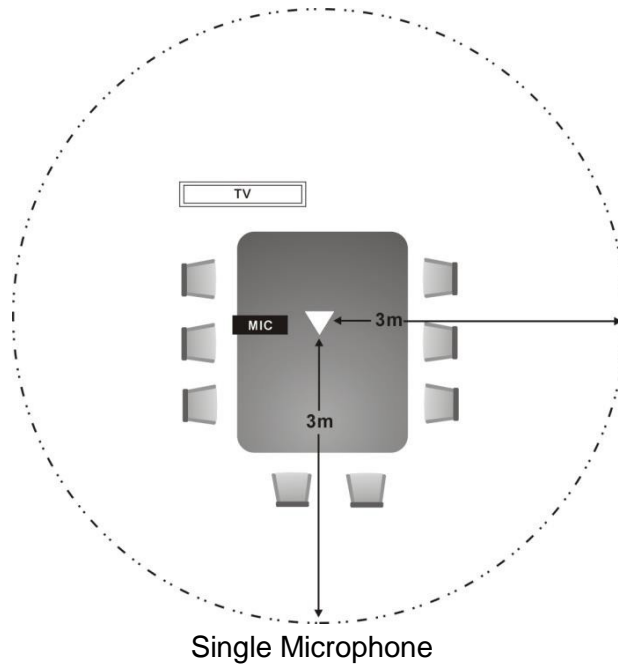

Two Microphones



# TRIUMPH BOARD Video Conferencing System VC1

## Wizard Setup

For the first time using TRIUMPH BOARD Video Conferencing System VC1, the Installation Wizard will guide the user to setup Video Conferencing System VC1 step by step. After completing the wizard setup, user may start to use the Video Conferencing System VC1.

In Installation Wizard, user can use the following buttons on remote controller to move between the selections and make/confirm selection.

: To expand the drop-down list, make/confirm the selection.

/: Move the cursor up or down.

: Move the cursor to right or on **Next** button.

: Move the cursor to left or on **Back** button.





### START



**Please follow the below description to complete the wizard setup.**

Connected the Video Conferencing System VC1 well and turn on the power. After Video Conferencing System VC1 starting, user will see the Installation Wizard screen shown up.

### LANGUAGE

**Select the language of the Video Conferencing System VC1.**

Press  to expand the drop-down list. Then, use  or  button to move the selection and press  to make the selection. After selecting,

press  to move to Next option and press  to go next step.

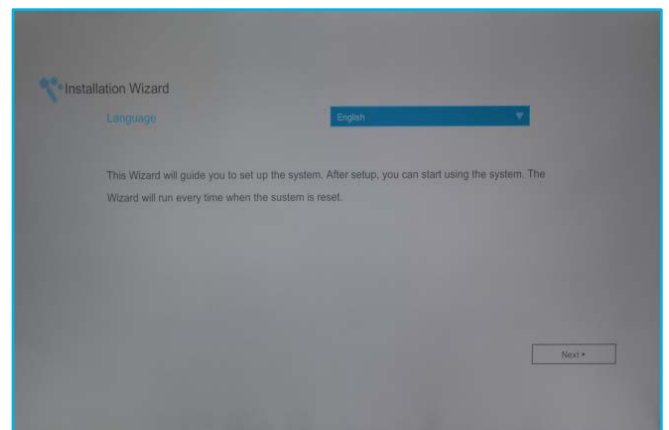

## SITE NAME

**Assign a name for Video Conferencing System VC1 system. Use the numeric pad on remote controller to enter the site name.**

After entering the site name, press **>** to move to Next button and press **↩** to go next step.

To go back to last step, press **<** to move to Back option and press **↩** to confirm.

### [Note]

- (1) Repeat press the number button to select the character that user wants to enter.
- (2) The site name is character only

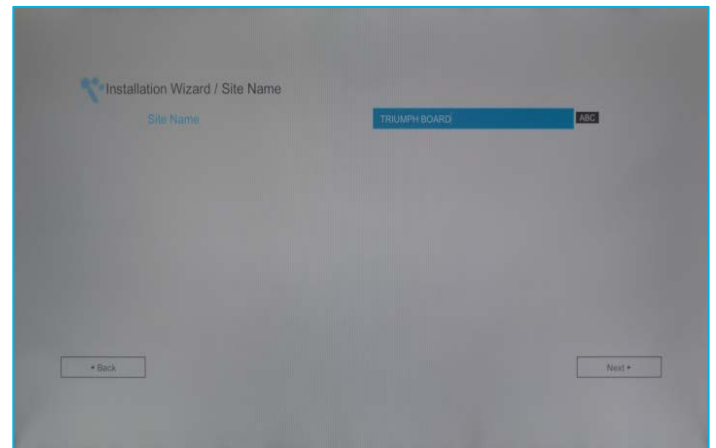

## NETWORK SETTING

**Select the network environment that user has used.**

Use **▲** or **▼** button to move to the selection and press **↩** to confirm the selection.

### [Note]

User can refer to chapter of Scenarios For LAN Connection for the description of network environment.

After selecting the network setting option, user need to configure the network parameters. Follow the below description to setup the network settings.

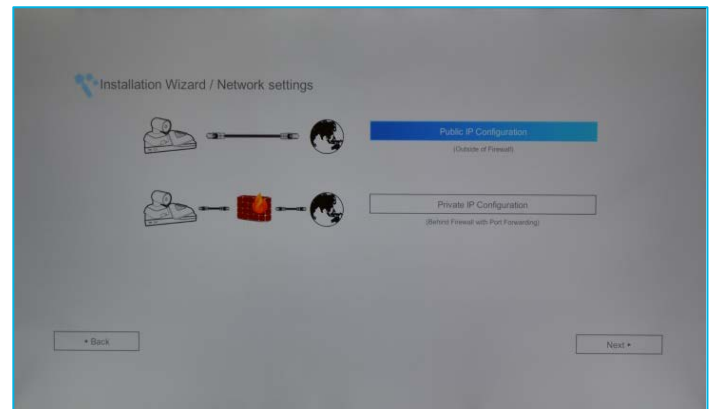

## PUBLIC IP CONFIGURATION (OUTSIDE OF FIREWALL):

**Your Video Conferencing System VC1 is connecting directly to the internet. Select the IP mode.**

**Obtain IP address by DHCP:** Configure the system to automatically obtain an IP address from the DHCP server. The Video Conferencing System VC1 will automatically get a IP address which assigned by your DHCP server on LAN. The IP address and related information will display. Click **OK** to accept the setting.

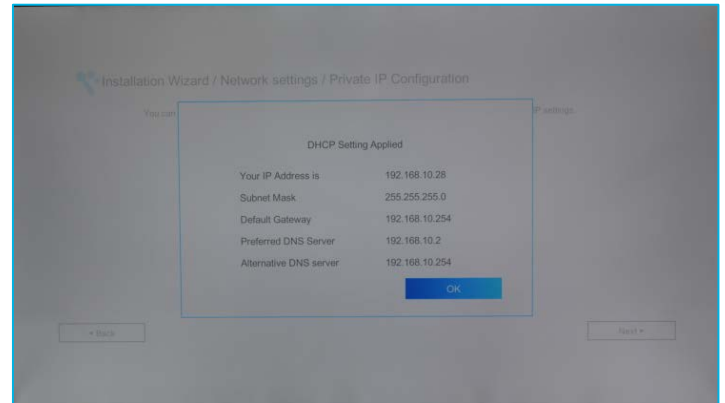
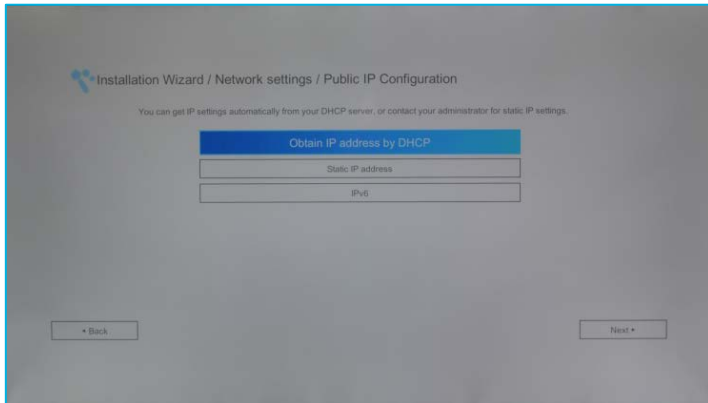

**Static IP:** Configure the system to use the assigned IP address. Select this when the public IP address is available.

Enter the following information and click **Apply** to save the settings. To go to next step, click **Next** and click **Back** to go back to **Network Setting** page.

1. **Your IP Address is:** Enter your IP address manually.
2. **Subnet Mask:** Enter the subnet mask address when the system does not automatically obtain the subnet mask
3. **Default Gateway:** A gateway is a network point that acts as an entrance to another network. Enter the gateway address when the system does not automatically obtain the gateway.
4. **Preferred DNS Server:** Domain Name System (DNS) servers convert human friendly names (for example: www.example.com) to IP addresses (218.77.272.166) that let machines be found on the network. The preferred DNS server is the one your computer asks first. The alternate is a backup. Enter the Preferred and Alternated DNS Server address.
5. **Alternate DNS Server:** Enter another Domain Name server for second choice.

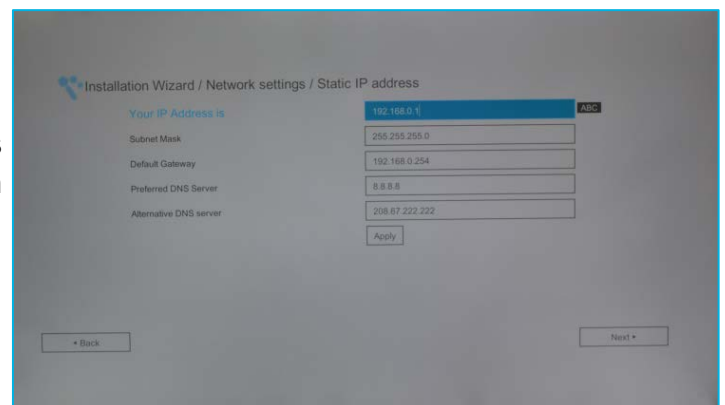

**IPv6:** IPv6 is an evolutionary upgrade to the Internet Protocol. IPv6 will coexist with the older IPv4 for some time. IPv6 addresses are 128-bit IP address written in hexadecimal and separated by colons.

Select and enter the following information and click **Apply** to save the settings. To go to next step, click **Next** option and click **Back** to go back to **Network Setting** step.

### 1. Obtain Address is

- (1) **Static IP:** Configure the system to use the assigned IP address. Select this when the public IP address is available.
- (2) **Auto:** Obtain the dynamic IP address automatically. User needs to enter the IP address and prefix length in following.

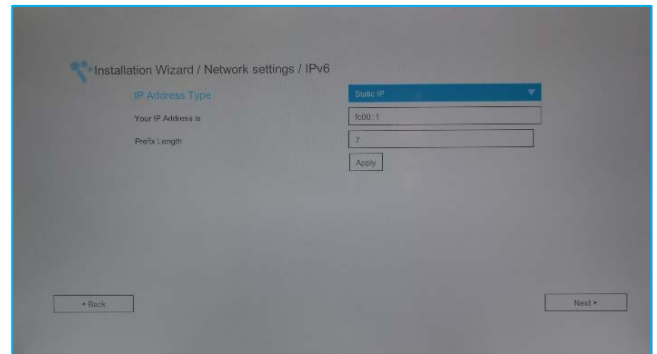

**2. Your IP Address is:** Enter your IP address manually.

**3. Prefix Length:** Prefix Length allows you to place as many IPv6 devices as the underlying network medium allows.

## PRIVATE IP CONFIGURATION (BEHIND FIREWALL PORT FORWARDING):

**Your Video Conferencing System VC1 is connecting to the internet through a firewall.**

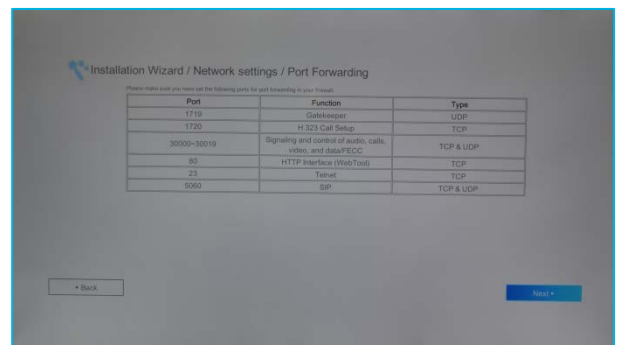
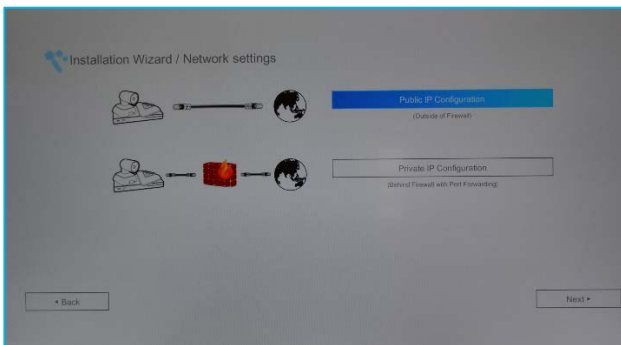

☞ Please make sure you have set the following ports in port forwarding in your firewall. Then, click Next to select the IP mode of your network

**Obtain IP address by DHCP:** Configure the system to automatically obtain an IP address from the DHCP server. The Video Conferencing Video Conferencing System VC1 will automatically get a IP address which assigned by your DHCP server on LAN. The IP address and related information will display. Click **OK** to accept the setting.

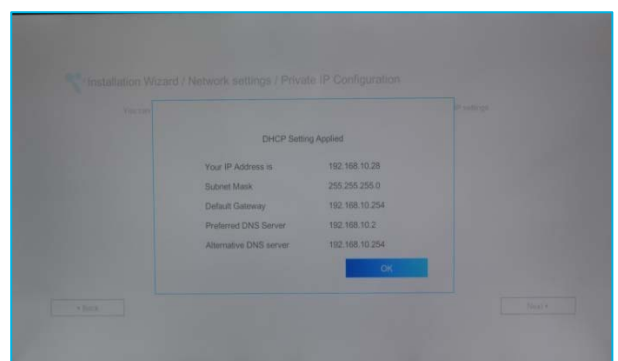

**Static IP:** Configure the system to use the assigned IP address. Select this when the public IP address is available.

Enter the following information and click **Apply** to save the settings. To go to next step, click **Next** and click **Back** to go back to **Network Setting page**.

1. **Your IP Address is:** Enter your IP address manually.
2. **Subnet Mask:** Enter the subnet mask address when the system does not automatically obtain the subnet mask
3. **Default Gateway:** A gateway is a network point that acts as an entrance to another network. Enter the gateway address when the system does not automatically obtain the gateway.
4. **Preferred DNS Server:** Domain Name System (DNS) servers convert human friendly names (for example: www.example.com) to IP addresses (218.77.272.166) that let machines be found on the network. The preferred DNS server is the one your computer asks first. The alternate is a backup. Enter the Preferred and Alternated DNS Server address.
5. **Alternate DNS Server:** Enter another Domain Name server for second choice.

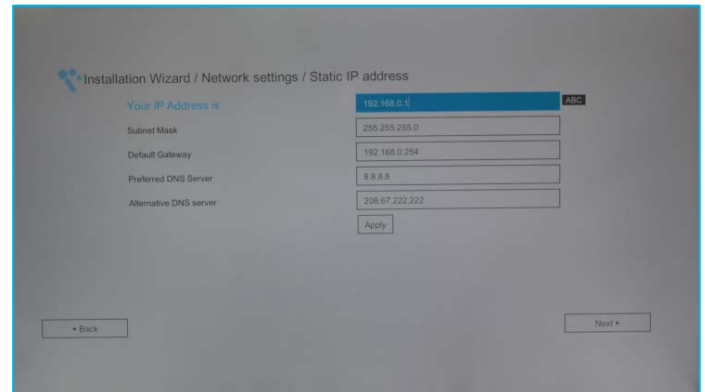

**IPv6:** IPv6 is an evolutionary upgrade to the Internet Protocol. IPv6 will coexist with the older IPv4 for some time. IPv6 addresses are 128-bit IP address written in hexadecimal and separated by colons.

Select and enter the following information and click **Apply** to save the settings. To go to next step, click **Next** option and click **Back** to go back to **Network Setting** step.

1. **Obtain Address is**
  - (1) **Static IP:** Configure the system to use the assigned IP address. Select this when the public IP address is available.
  - (2) **Auto:** Obtain the dynamic IP address automatically. User needs to enter the IP address and prefix length in following.
2. **Your IP Address is:** Enter your IP address manually.
3. **Prefix Length:** Prefix Length allows you to place as many IPv6 devices as the underlying network medium allows.

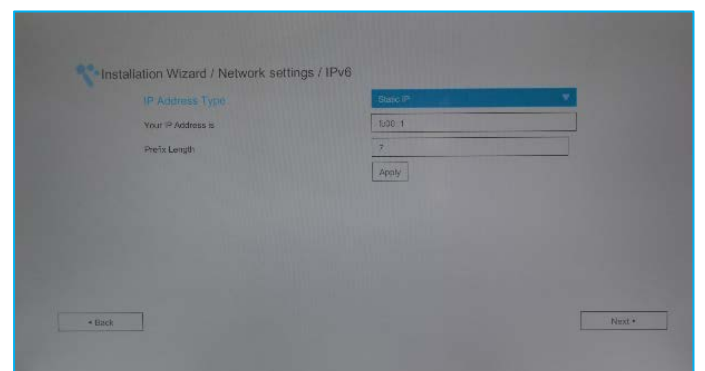





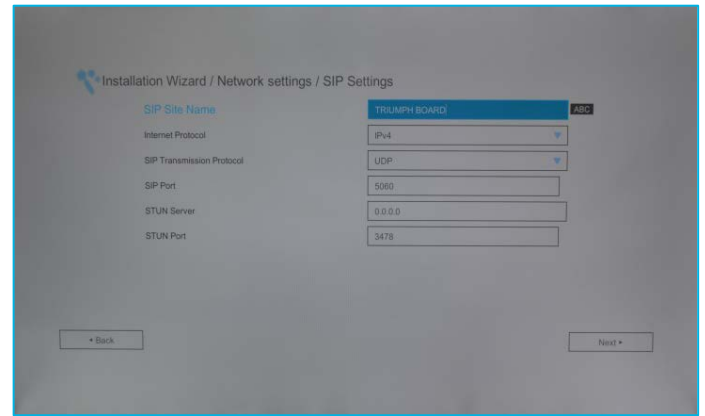
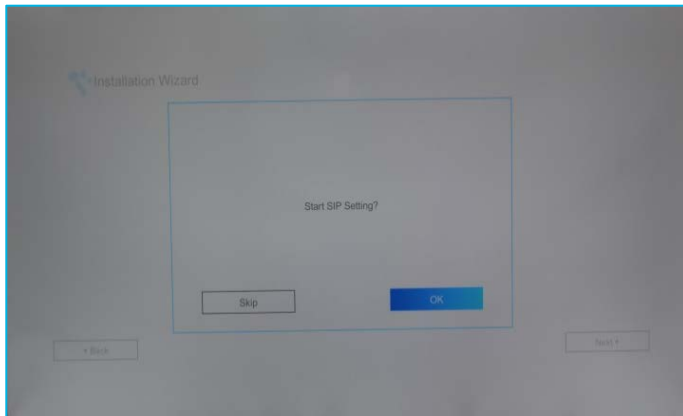

## SIP SETTING

**Session Initiation Protocol (SIP)** allows you around the world to communicate using your supported devices over the Internet. After setting network, user can choose to setup SIP or Skip SIP setting.



To setup SIP, enter or select the following information

1. **SIP Site Name:** Enter the SIP site name for others to identify. The SIP site name may be the same or different than the domain for Web activity. Use numeric pad to enter the SIP site name in column.
2. **Internet Protocol:** Select to use **IPv4** or **IPv6** as IP protocol. Press  to expand drop-down list and use ,  to move the selection. Press  to confirm the selection.
3. **SIP Transmission Protocol:** Select the SIP Transmission Protocol type from the drop-down list for using. There are two types of Internet Protocol (IP) traffic. They are Transmission Control Protocol (TCP) and User Datagram Protocol (UDP). To ensure proper connection, verify if both calling parties are using the same transport protocol. By default, it is set to UDP.
  - (1) **TCP:** TCP is connection oriented. Once a connection is established, data can be sent bidirectional.
  - (2) **UDP:** UDP is a simpler, connectionless Internet protocol. Multiple messages are sent as packets in chunks using UDP.

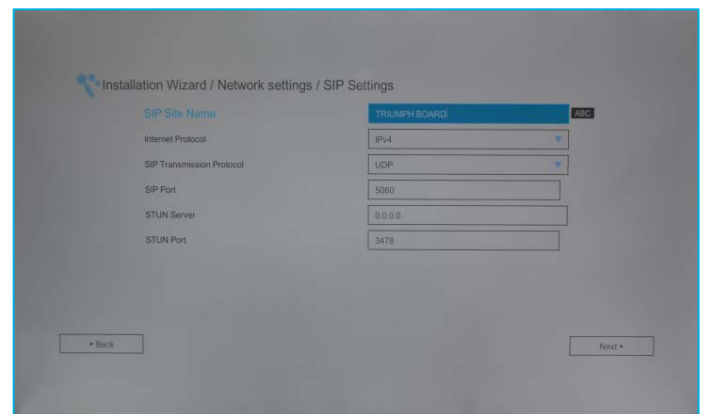

4. **SIP Port:** Change this value only if you use specific settings in your network system. By default, the SIP port is set to 5060.
5. **STUN Server:** STUN (Session Traversal Utilities for NAT) is a standardized set of methods and a network protocol to allow an end host to discover its public IP address if it is located behind NAT.
6. **STUN Port:** Enter the port number of STUN server.

## SIP SERVER REGISTRATION

A typical SIP session involves a client requesting a session with a SIP server. After the request is received, the SIP server returns a response to the user indicating the availability of the session. After setting SIP, user can choose to setup **SIP Server Registration** or **Skip**.

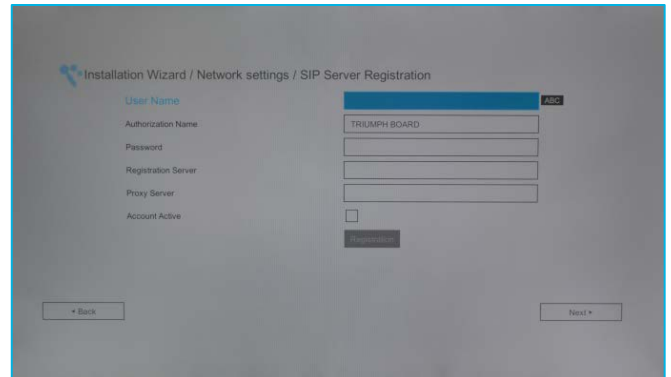
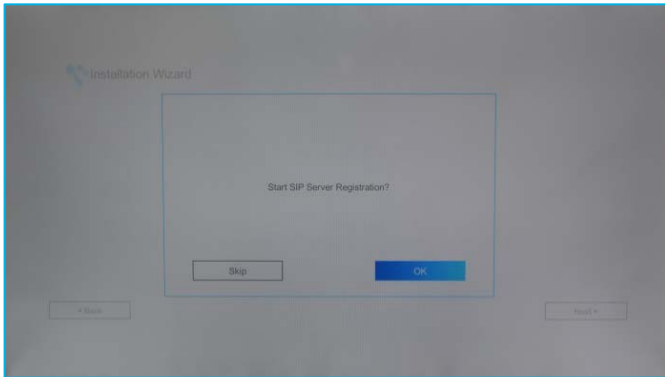

To setup SIP Server Registration, enter the following information and click **Register** to save the settings. After completing, click **Next** to go next step.

1. **Terminal Name:** Enter the terminal server name.
2. **Terminal Password:** Enter the password of terminal server.
3. **Registration Server:** Registrar Server accepts registrations from users and places these registrations, (which is essentially location information), in a database known as a location service. Enter the Registrar Server name that you want to use.
4. **Proxy Server:** Proxy Server is computing device (typically a server) that interfaces between data processing devices and others within a communications network. These devices may be located on the same local area network or an external network. Enter the used Proxy Server name.

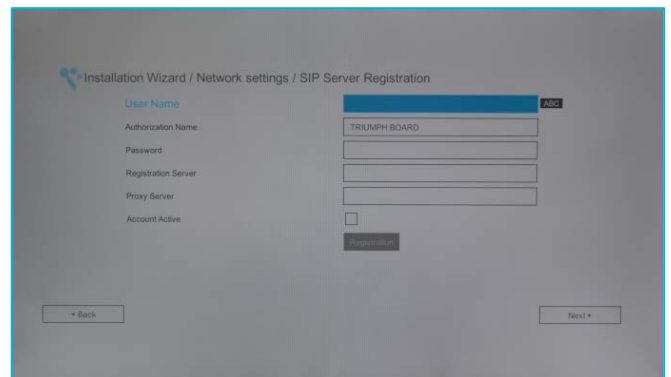

## DATE AND TIME SETTING

Setup the Video Conferencing System VC1 date and time. User can choose to use NTP server to adjust the date/time or manually enter the current date/time.

### NETWORK TIME PROTOCOL (NTP)

Network Time Protocol (NTP) is a protocol that is used to synchronize system clock times in a network of device.

- 1. NTP Server:** The Network Time Protocol (NTP) allows administrators to synchronize all network computers to a main server. This keeps all network machine clocks on the same time. Enter the NTP Server name that you want to follow.
- 2. Time Zone:** Timezone allows you to adjust the time when you are in a different country or area so that you can keep the same time with your original area. Most of the time zones on land are offset from Coordinated Universal Time (UTC) by a whole number of hours (UTC-12 to UTC+14)

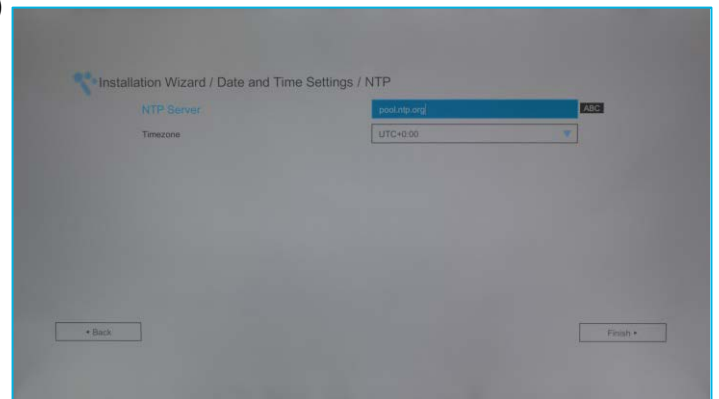

### MANUALLY SETTING

Enter the present year, month, date, hour, minute, and second by yourself

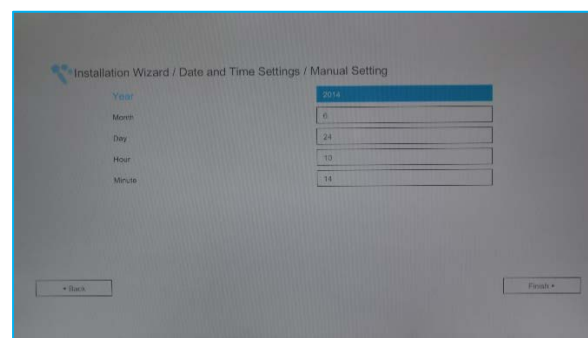
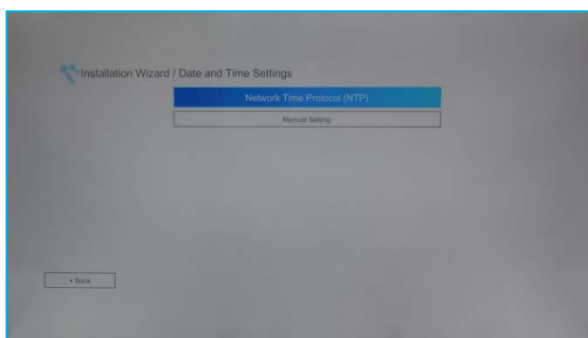

After completing date/time setup, click **Go to Main Menu** to complete the Installation Wizard setup. Before that, user can do a call test or go to home menu. How to dial a call; refer to chapter of **Making a Call**.

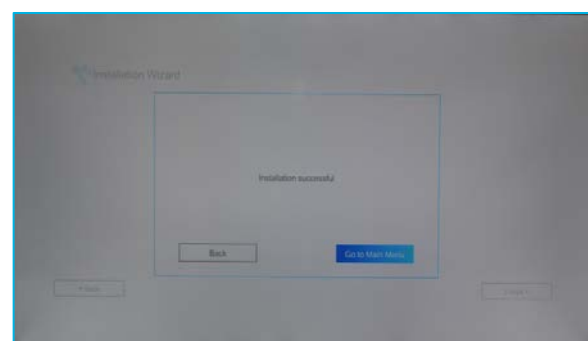

# TRIUMPH BOARD Video Conferencing System VC1

## OPERATION

Connecting the camera, microphone, main system, display and power, press the power button to turn on Video Conferencing System VC1. Power button starts blinking blue light, TRIUMPH BOARD logo shows up. In 30 seconds camera image and home screen appear on screen. Aim the remote controller to camera and start configuring TRIUMPH BOARD Video Conferencing System VC1.

## Before You Begin

### Basic Operation

**Navigation buttons:** Use the , ,  and  buttons to move the selection on the remote controller.

**Enter button:** Use the  to confirm the selection on the remote controller.

**Apply:** Make the changed value to take effect. (For TRIUMPH BOARD Video Conferencing System VC1 Application)

**Save:** Accept the created value and save it to the system.

**Cancel:** Cancel the changed value and exit the present screen.

## Home Screen

There are 4 selections on the Home screen: **Dial**, **Phonebook**, **Call History**, and **Setting**. Simply use the navigation buttons to move between selections and press  to confirm the selection. You can easily place a call and select the site contact either in **Dial**, **Phonebook** or **Call History**. The administrator can set a security password to prevent changes made to the system setting and WebTool access.

### CONFIGURATION ICONS

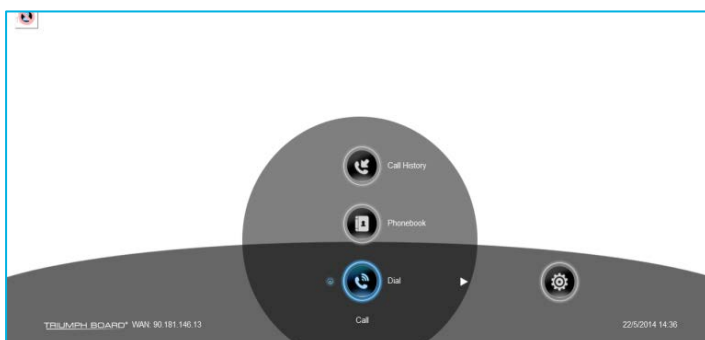

Dial, Phonebook and Call History

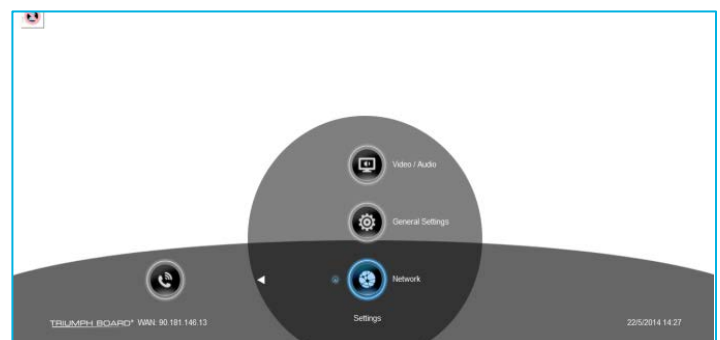



Settings include General Setting, Video/Audio and Network.

## COMERA AND MIC ICONS

On the upper left-hand corner of your home screen, you may see camera and MIC indications.

If the Camera connection is ok,  is on the upper left corner of your home screen. Otherwise, “**Camera Disconnected**” warning message is displayed and screen is blue.

If the MIC connection is ok,  is on the upper left corner of your home screen. Otherwise,  is displayed indicating microphone is mute. Try pressing the mute button on microphone or remote controller to unmute it (LED indicator on microphone turns blue).

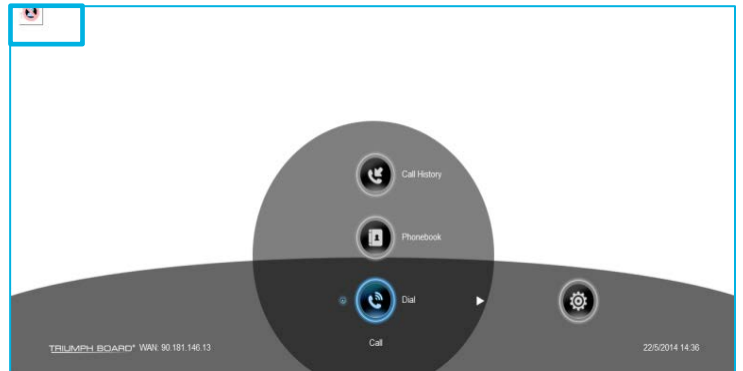

## WAN ADDRESS

On the lower left corner of your home screen, you can find current WAN IP address.

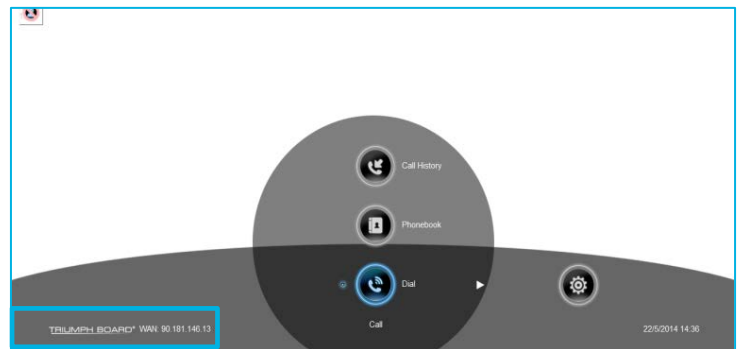

## REAL-TIME CLOCK

On the lower right corner of your home screen, you can find the current Date and Time once system sets up properly.

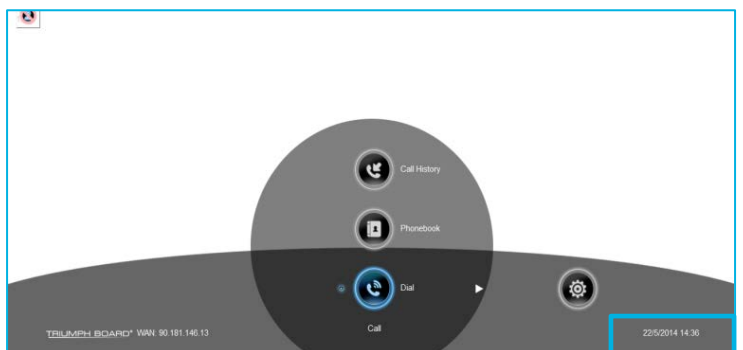

## Dial

Dial selection allows you to enter dial screen and make a call. Press  button on the remote controller has the same effect.

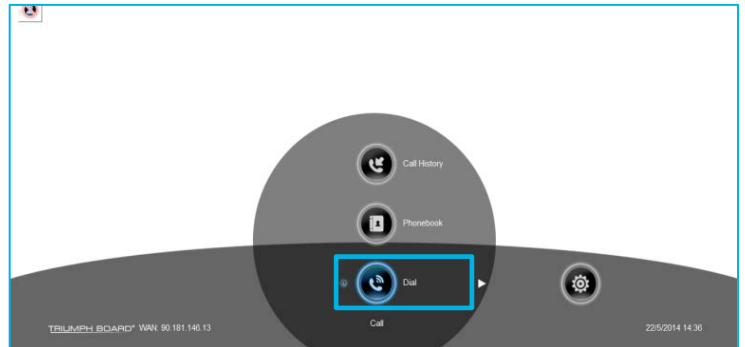

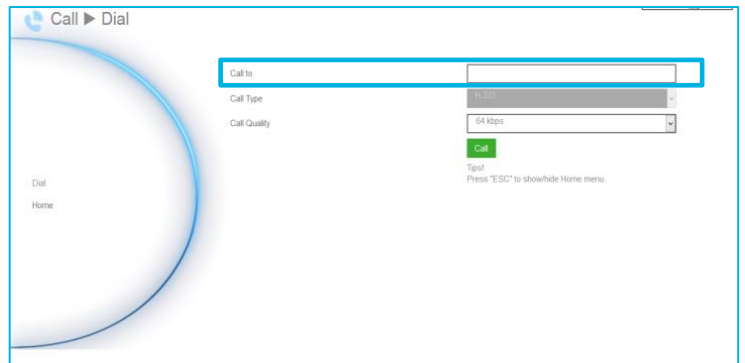

### IP Address

Use the number keys on the remote controller to enter the IP address or number or SIP URI (sip:username:password@host:port) you want to call. TRIUMPH BOARD remote controller supports alpha-numeric operation, press numeric key multiple times to select the alphabet or symbol.



### Call Type

TRIUMPH BOARD Video Conferencing System VC1 supports H.323 and SIP calls. H.323 is commonly used to communication to other videoconferencing room systems. SIP is commonly used to communicate with other VoIP devices. Use the  button to select which type of call type you want to make then press  to confirm.





## Call Quality

For the **Call Quality** selection, enter the desired call quality (or network bandwidth) from the drop-down list (default or 64K up to 4M bit per second).

### [Note]:

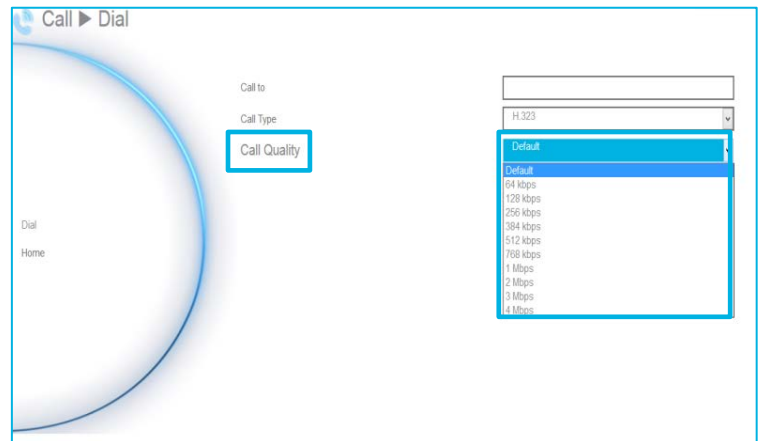
For using bandwidth effectively, we suggest using H.264 video codec and G.722.1c audio codec when the SIP connection is at 64kpbs



Select the **“Call”** on the Dial configuration screen then press  to make a call.

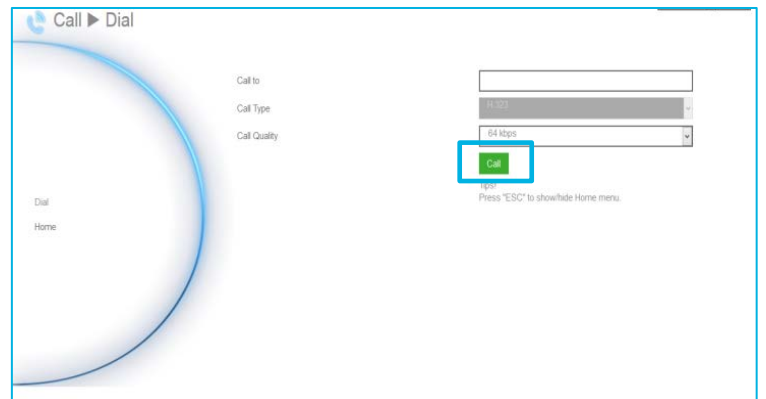

Make sure the network jack is plugged in and network is working properly before making a call; otherwise, the **“Network Jack Unplugged”** information will appear. Click **“OK”** to reconfirm the network connection.

# Phonebook

Phonebook allows you to create and edit contact information, group contacts by category, search contacts then make a call. The group and contact (site) name in the directory will be sorted in alphabetical order. You may use the WebTool to edit or import the phonebook entries too.

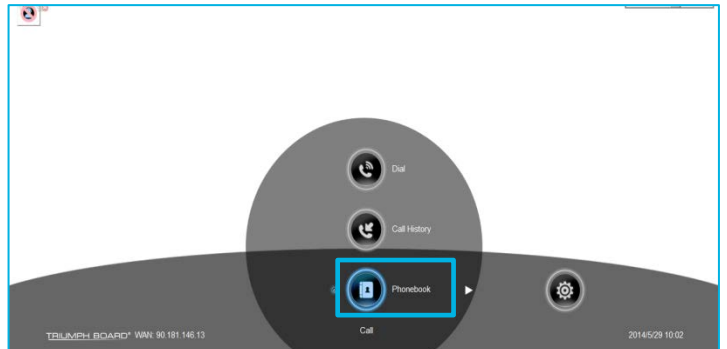

## GROUP

Select **Phonebook** and press .

Select **Group** and press .

If you have lots of contacts, it is better to categorize them to groups such as client, vendor, company, branch, etc. to make the lookup easier.



## Create a New Group

In the **Group** configuration screen, Press **“Red”**  button on the remote controller to pop up the **“Enter Group Name”** dialogue box.



Enter the group name that you want to create.

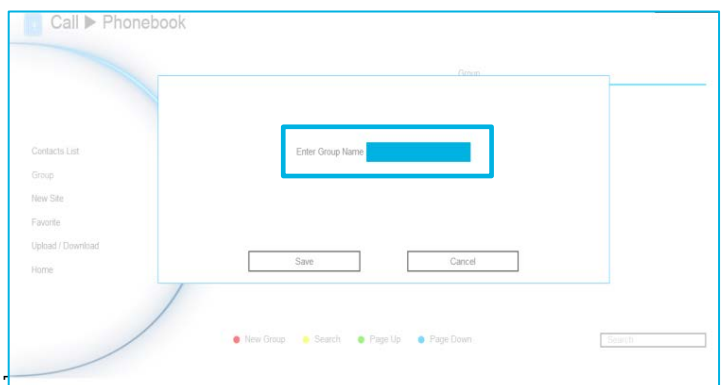



Select **“Save”** to save the new group. Or select **“Cancel”** to exit the **“Enter Group Name”** dialogue box.

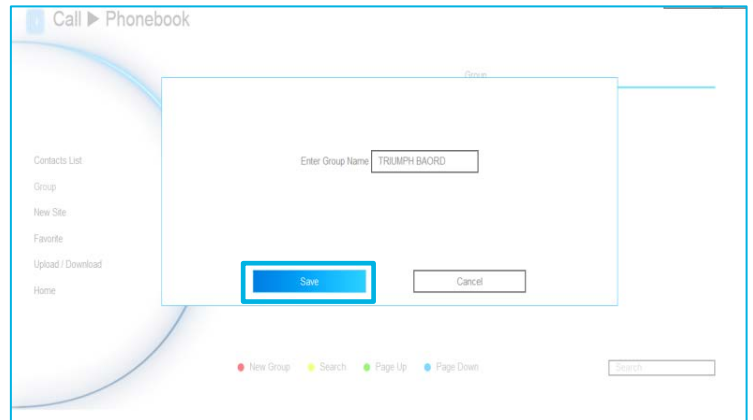

The new group name will be saved and displayed in the group list.





### Search a Created Group

Press **“Yellow”**  button on the remote controller and enter the group name that you want to search.

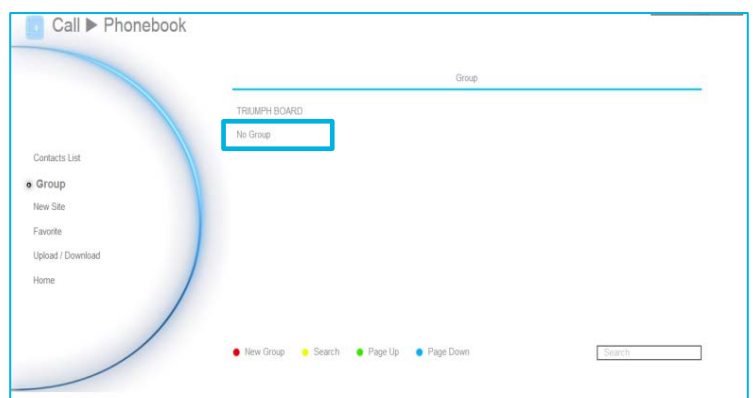

If the name you enter has not been created, the system will show you **“No Group Available”**, please search again.



If the Group data are over one page, you can also press **“Green”**  button or **“Blue”**  button to Page Up or Page Down.



## Edit Group

Select **Phonebook** | **Group** and press .

Select the name you want to modify in the group list.

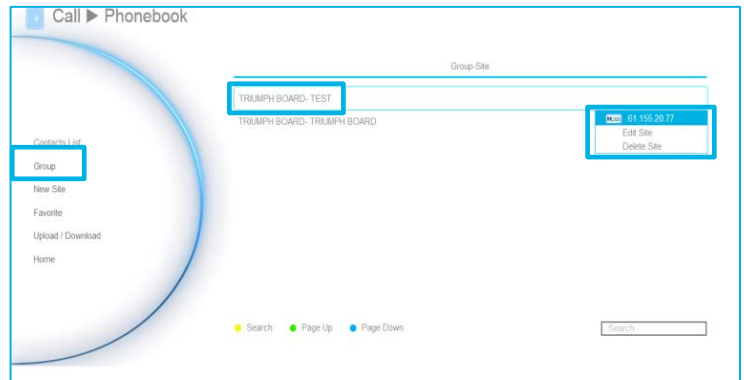

Select **“Edit Group”** and press .

Modify the group name and select **“Save”** to save the revised group name.

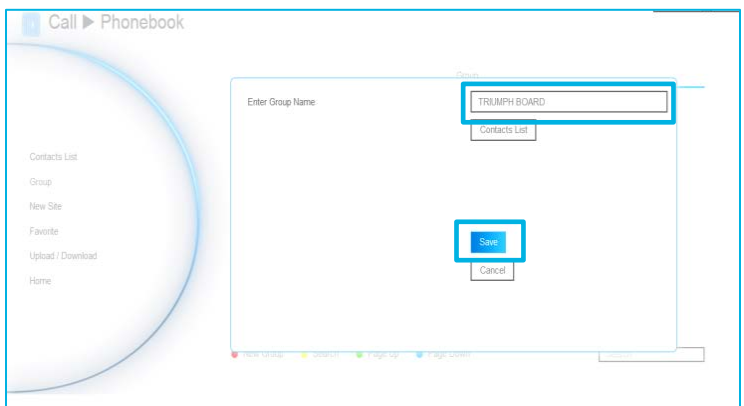

The revised group name will be saved and displayed in the group list.



 If the revised name is the same as the saved name, the revised name will be ignored.

## Add Contact from Group List

Select **Phonebook** | **Group** and press .  
Select the Group name you want to add to Contacts List.

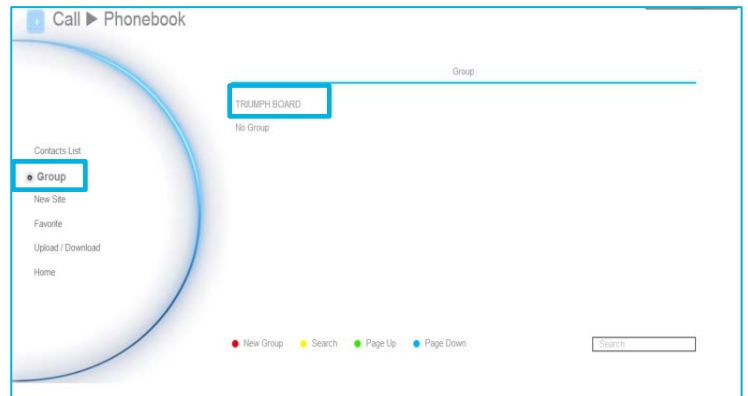

Select **“Edit Group”** and press .

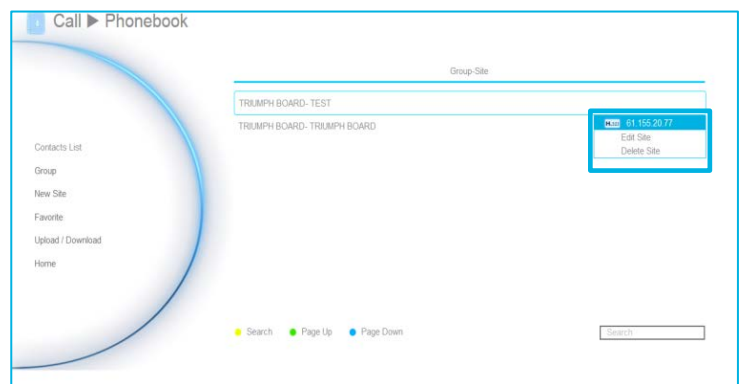

Confirm the Group Name what your want to add to the contracts list and then select **“Contacts List”**.

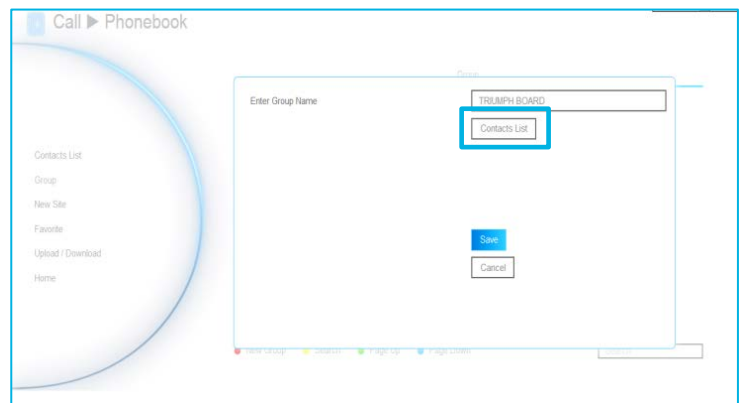

In the Group Site list, select the item that you want to add to the contracts list and then press **“Red”**  button on the remote controller to save the selection.

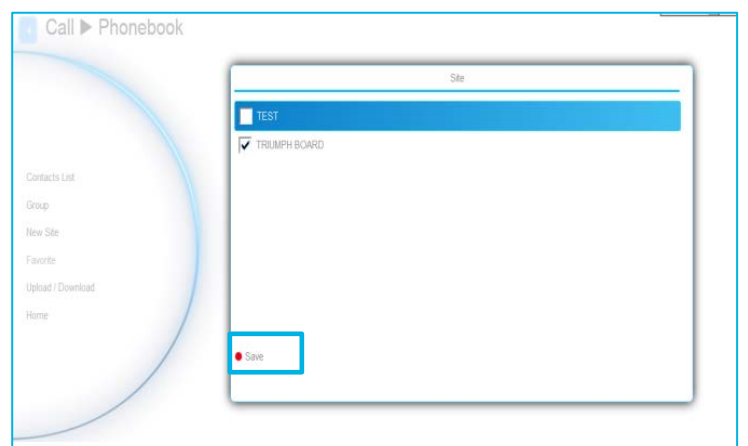

Select **“Save”** to save the Group name and added site to the contacts list.

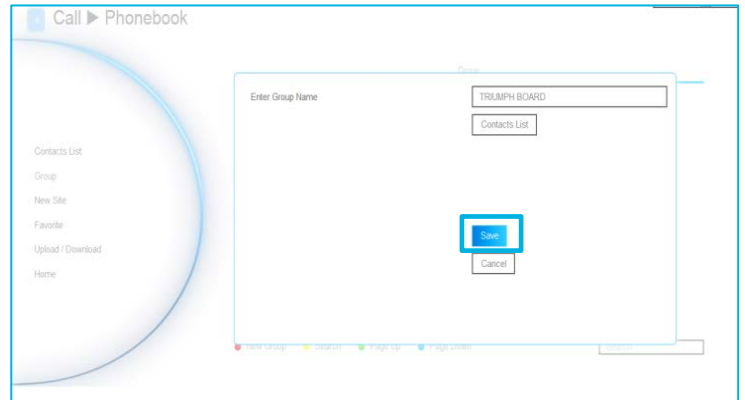

The selected Group name and added site will be added into the contacts list.

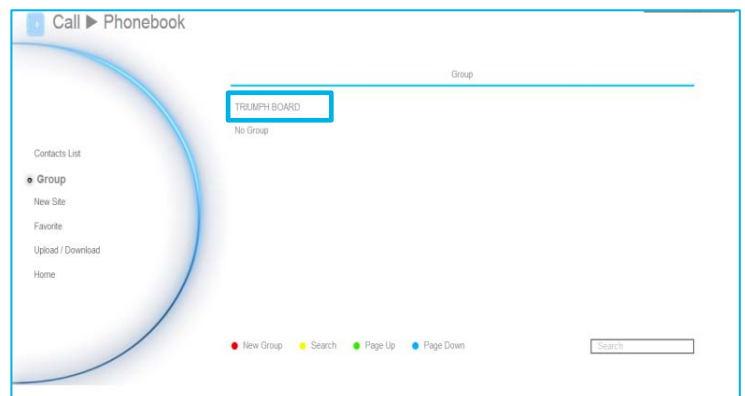

## Delete Group

Select **Phonebook | Group** and press  .  
Select the name you want to remove in the group list.

Select **“Delete Group”** and press  .

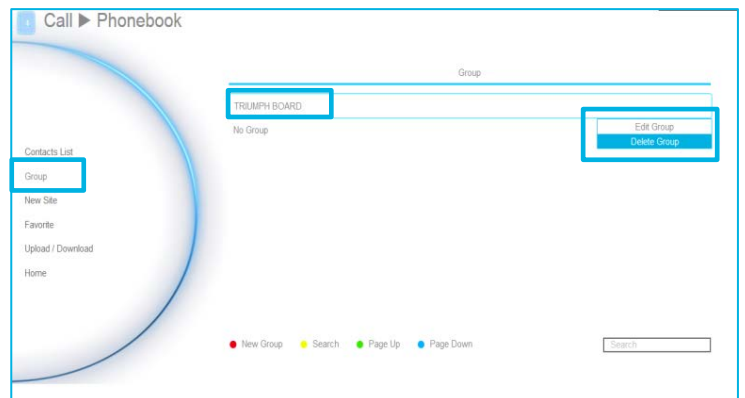

Select **“Yes”** to remove the selected group name and **“Cancel”** to cancel group name deletion.

The selected group name will disappear in the group list when deleted.

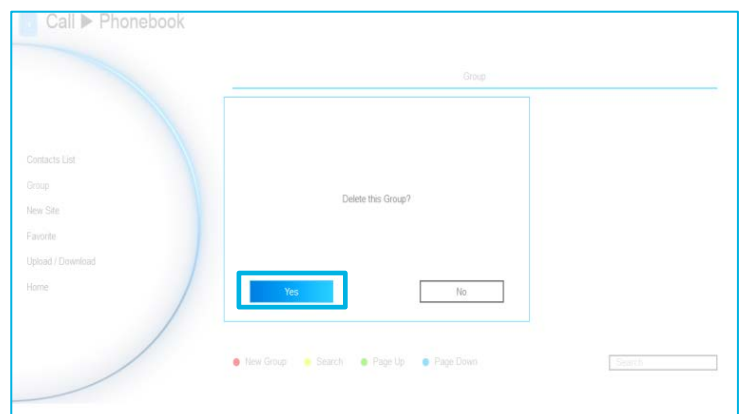

## NEW SITE (CONTACT IN PHONEBOOK)

New Site allows you to create and edit the information to each site.

### Add New Site

Select **Phonebook** | **New Site** and press



Select the **Group** name, if you don't want to add the entry into a group, please select **"Non-Group"** item.

Select **Site Name** box. Enter the site name

with the remote controller and press



Enter the used call type information either H.323 or SIP.

Select the desired call quality value in the drop-down list.

Select **“Save”** to store the newly added site contact.

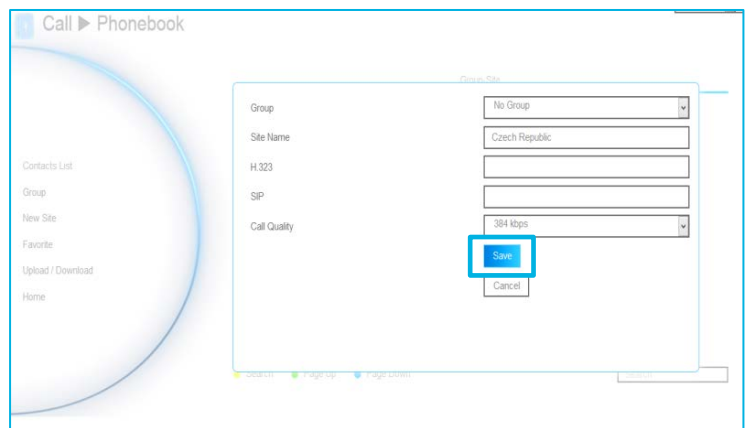

### Edit New Site

Select Phonebook | Contacts List and press



Select the contact you want to modify and

press



Select **“Edit Site”** and press

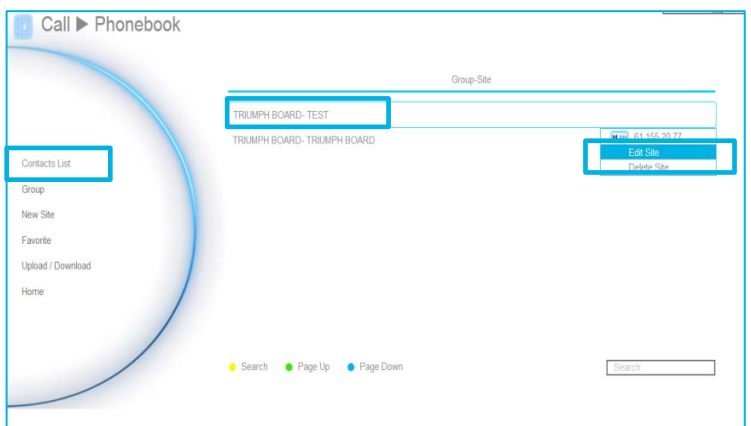

In the Edit Site screen, you may change the Group name, Site Name, H.323, SIP and Call Quality.

After making the changes, select **“Save”** to apply the new changes or **“Cancel”** to reserve the original settings.

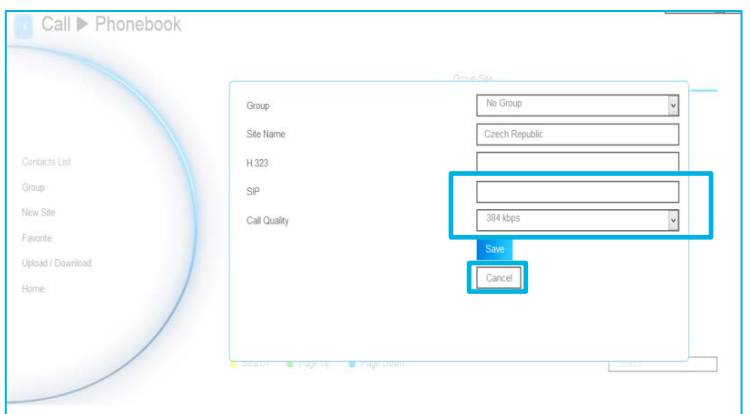

The saved changes will be shown in the Group Site list.

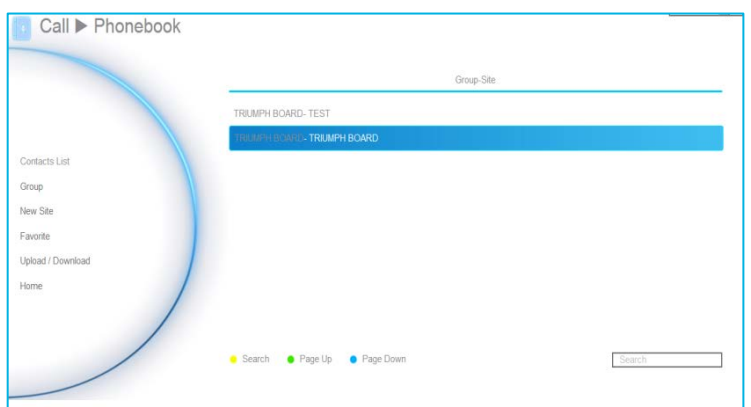

## Delete New Site

Select Phonebook | Contacts List and press



Select the contact you want to delete and

press



Select **“Delete Site”** and press

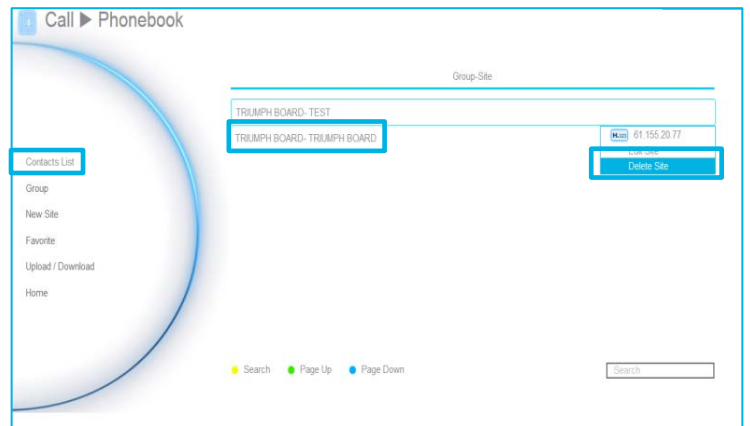

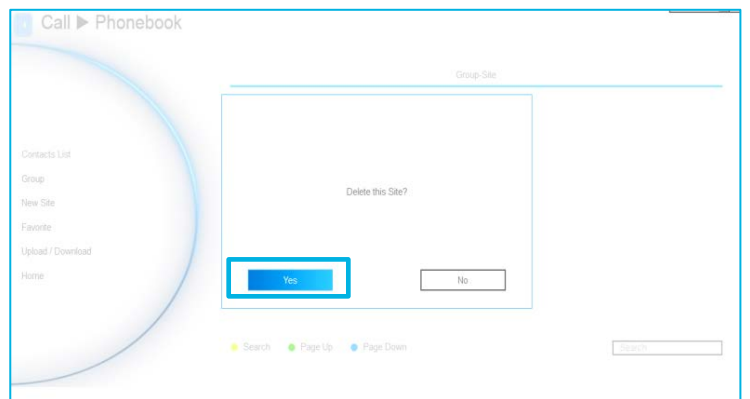

Select **“Yes”** to remove the selected contact and **“No”** to cancel contact deletion.

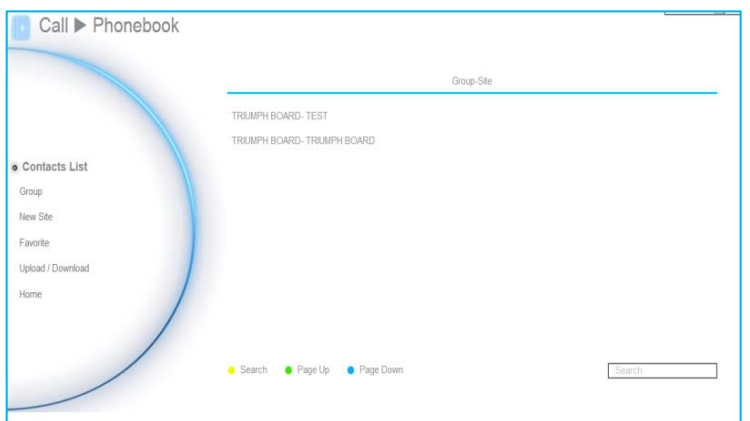

The selected contact will disappear in the Group-Site list when deleted.



## CONTACTS LIST

Contacts List shows you all of the contacts that you have created and saved. You can select the contact from the **Contacts List** directly for modifying or deleting. In the Contacts List configuration screen, you can also use the “**Yellow**”  button on the remote controller to search the contact that you want. If the Group-Site over one page, you can also press “**Green**”  button or “**Blue**”  button to Page Up or Page Down.

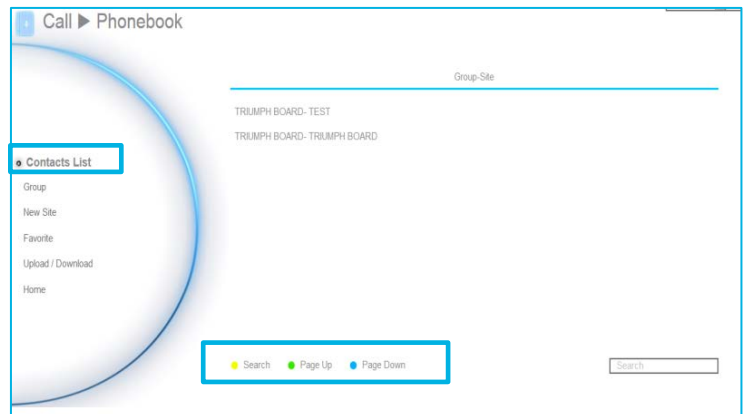

## FAVORITE

TRIUMPH BOARD Video Conferencing System VC1 allows you save up to 10 most used contacts in the favorite list.

Select **Phonebook** | **Favourite** and press .

Select which line (0~9) do you want to save the favorite contact and press .



Select the contact from the pop-up **Group Site** list and press “**Red**”  button on the remote controller to save the selection.

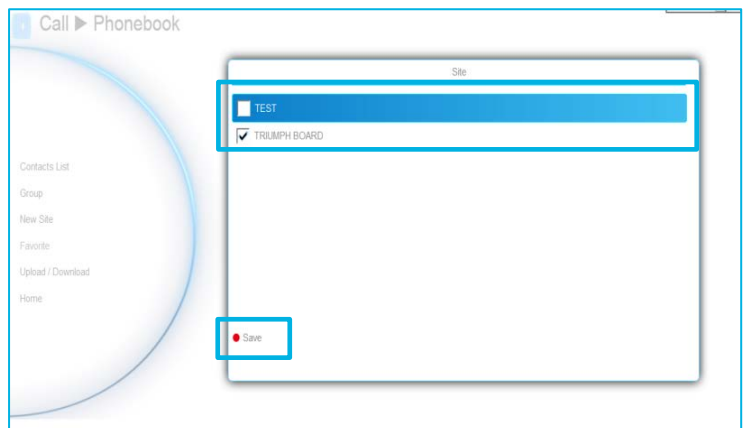

The item selected will be added into favorite list.





# Call History



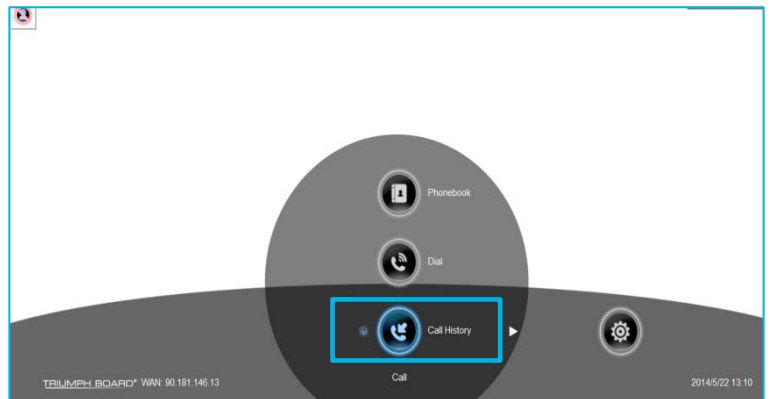

The Call History allows you to check the incoming/outgoing calls made and their status. You can also make a call by selecting it in the Call History list.



## Call Status

Select **Call History** and press .



The Call History will show you the IP address or the Site name with call type, Call Date/Time and Call status. Refer to the table below to check the call status.

Call Status	Answered	Failed
IN		
OUT		



Make a Call From the Call History

Select **Call History** and press .

Use the  and  buttons to move the selection and scroll up and down in the call history list.

Press  and select **“Call”** to make a call.



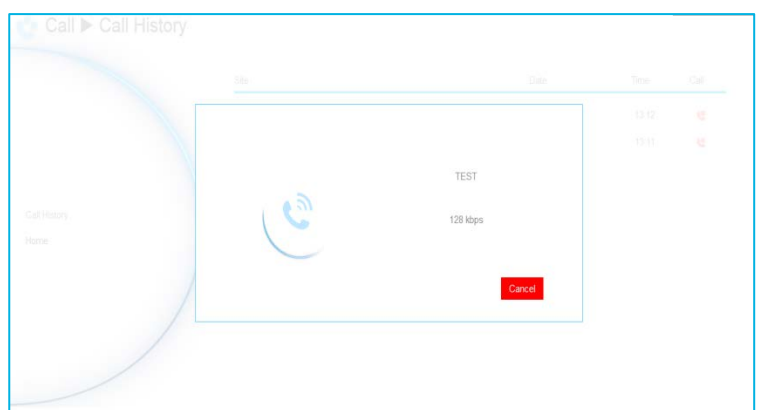

The call will be connected.



## Make a Contact from the Call History

You can also save the call in/out information into your contacts list.

Select **Call History** and press .

Use the  and  buttons to move the selection and scroll up and down in the call history list.

Press  and select **“Save”** to pop-up contact editing form. All relative information has filled in the contact form already based on the selected call entry from the Call History.

Confirm the **Group** selection then select **“Save”** to save the call entry into your contact.

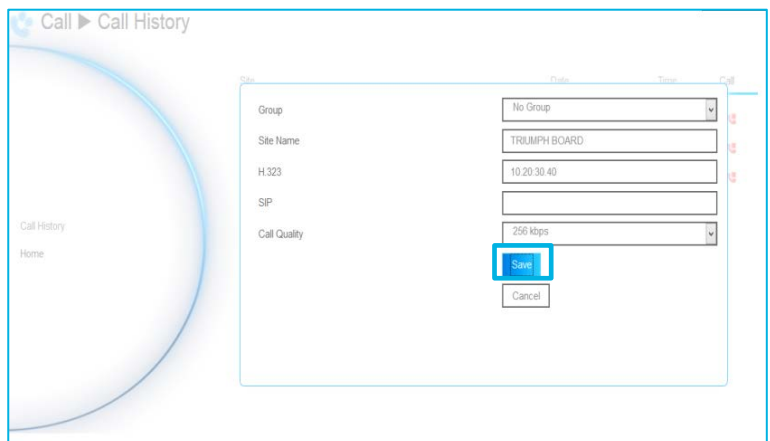
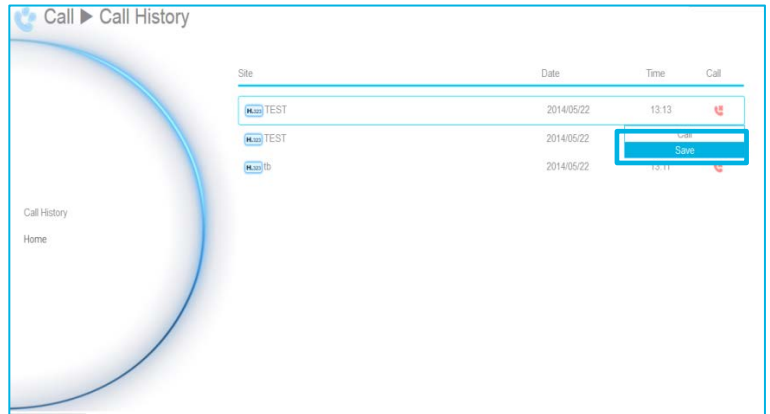

## General Setting

The General Setting allows you to modify system setting, check the system info, test the system and watch recorded conference files.

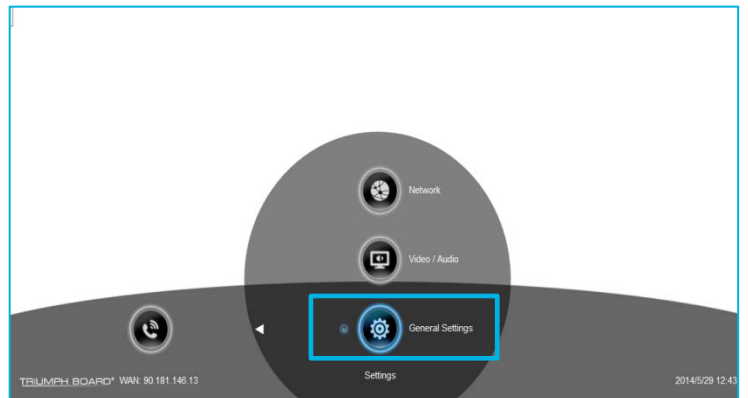

## SYSTEM INFO

The System Info shows you the relative information about your Video Conferencing System VC1 main system including Site Name, Model name, IP Address, MAC Address and System Version.



## CALL SETTINGS

Call Setting allows you to enter or change your system's site name which will appear on the screen during the call session for the other party to identify you. Set the system to enable/disable auto answer, set the default call quality, and enable/disable Advanced Encryption Standard which ciphers the data to protect against unauthorized data access.

### Auto Answer

Select General Setting | Call Settings and

press . Select **Auto Answer** and press . In the Auto Answer drop-down list, select **"OFF"** to turn off Auto Answer. **"ON"** to answer the call automatically and **"Do Not Disturb"** to automatically reject incoming calls. If you are already in a conference, even if the Auto Answer is turned on, you also need to accept the next call manually.

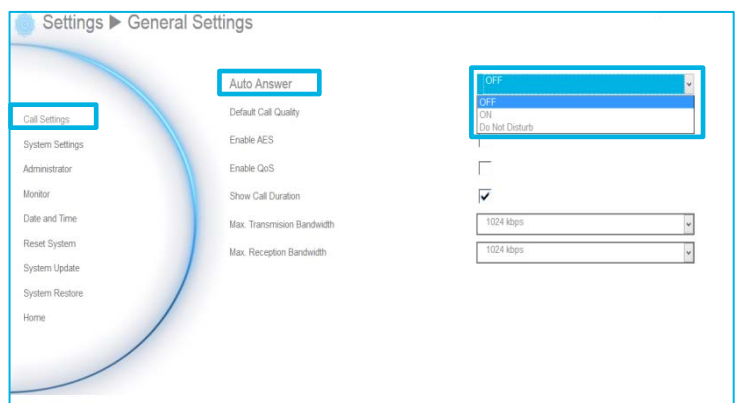

## Default Call Quality

Video Conferencing System VC1 main system supports 64k, 128k, 256k, 384k, 512k, 768k, 1024k, 1536k, 1920k, 2048k, 3072k, 4096k selection for default call quality. By default, it is set to 512k.

### [Note]:

For using bandwidth effectively, we suggest using H.264 video codec and G.722.1c audio codec when the SIP connection is at 64kpbs

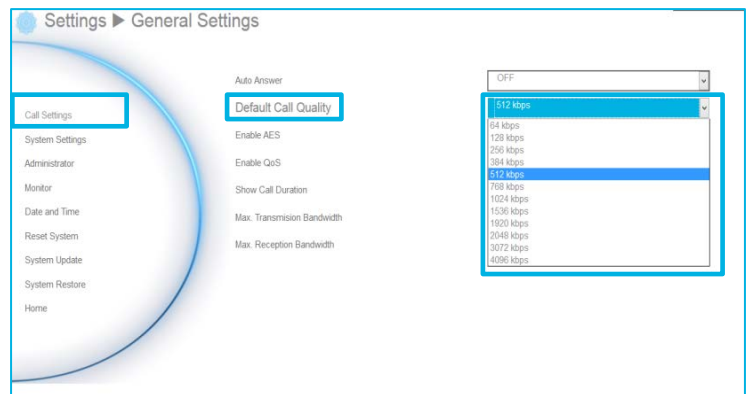



## Enable/Disable AES

Advanced Encryption Standard (AES) encrypts the data that is being transmitted during a video conferencing to provide protection against unauthorized data access. Encrypted data can only be read with the device that also supports the AES standard. All parties on the call must support AES to use this feature, or else the data will not be encrypted.

Select **General Setting** | **Call Settings** and

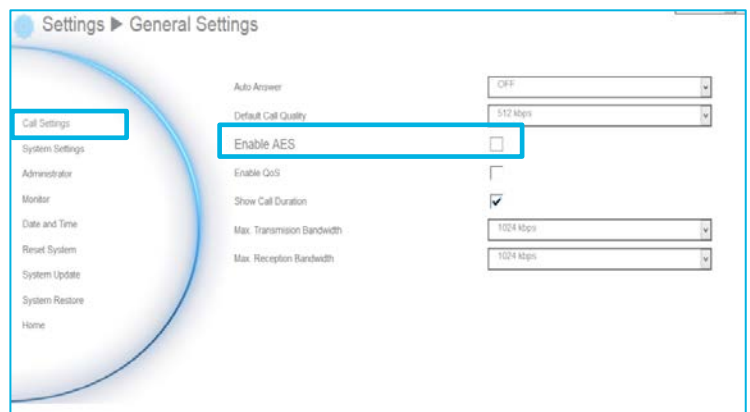
press . Select the **Enable AES** check box to active this function.



 This function may be restricted and unavailable in some countries.

## Enable/Disable QoS

Quality of Service (QoS) provides different priority data flows to guarantee a certain level of performance in video conferencing data flow. To activate QoS, select **General Setting**

**Call Settings** and press . Select the **Enable QoS** check box to active this function. By default, this function is disabled.

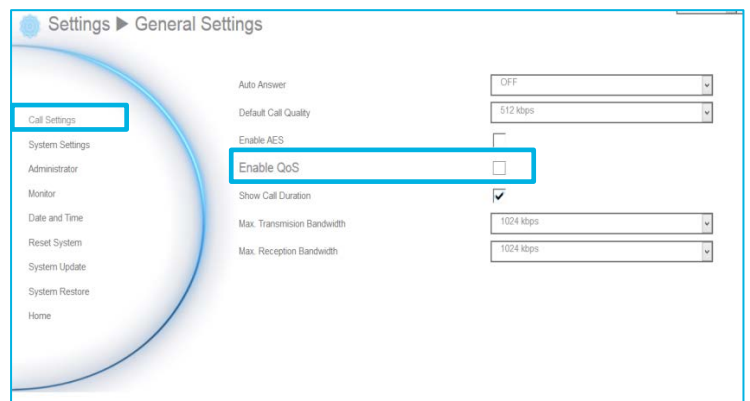

## Show Call Duration

Enable/disable the call duration showing, by default, this function is enabled.

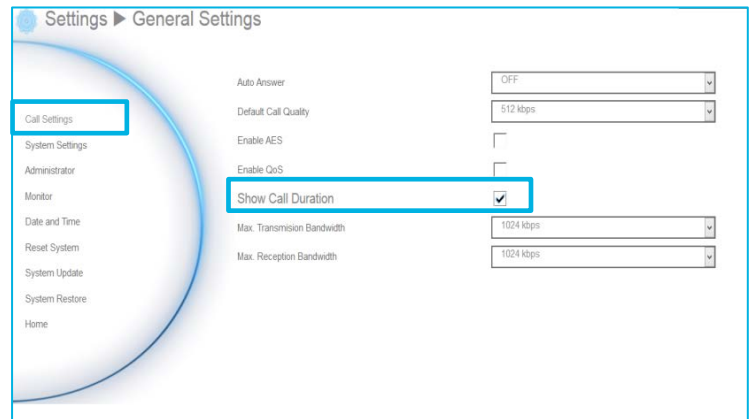

## Max. Transmitting/Receiving Bandwidth

This function allows you to specify the maximum bandwidth of the outbound and inbound calls. TRIUMPH BOARD Video Conferencing System VC1 system supports up to 4Mb.

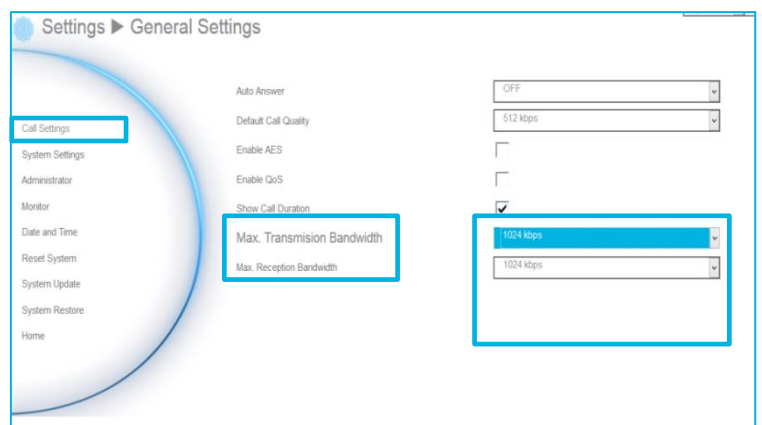

## SYSTEM SETTINGS

System Settings allows you to set Language, the time for Auto Power off and enable/disable Keypad Tone function for your main system.

### Language

Select General Setting | System Settings and press .

Video Conferencing System VC1 main system supports up to 27 languages for your selection. Select the language from the drop-down list directly and the language for the system will turn into the selected language automatically.

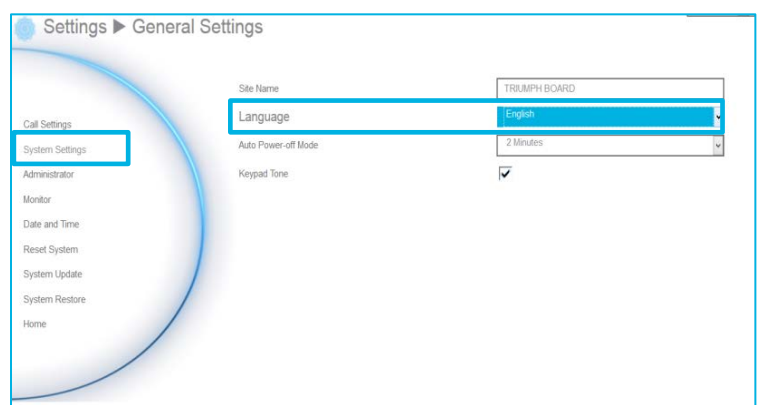

## Auto Power Off Mode

Auto Power Off Mode allows you to set the time to power off your system automatically after idling.

Select General Setting | System Settings and

press .

Select the time from the **Auto Power Off Mode** drop-down list (OFF/30Minutes/1Hour/2Hours/3Hours/4Hours). Disable this function, please select **“OFF”**. The function will completely turn off the system once you have set the auto power off time. To turn on the system you need to press the Power button on the man unit again.

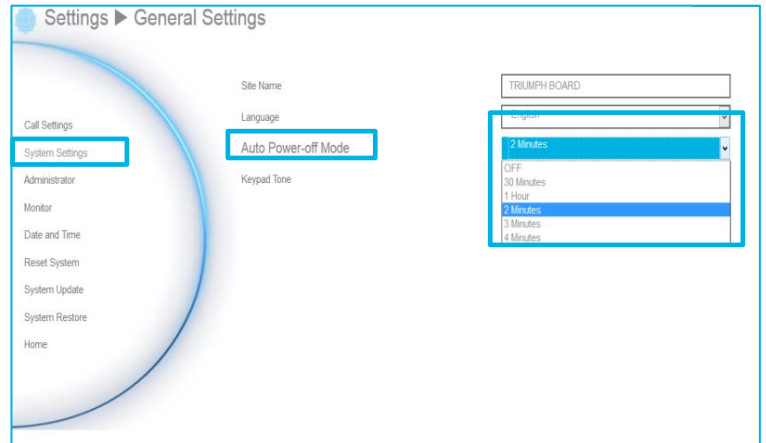

## Keypad Tone

Keypad Tone allows you to enable/disable tone sounds when you are dialing a number using the remote controller.

Select General Setting | System Settings and

press .

Select the Keypad Tone check box to enable the tone sounds. By default, this function is enabled.

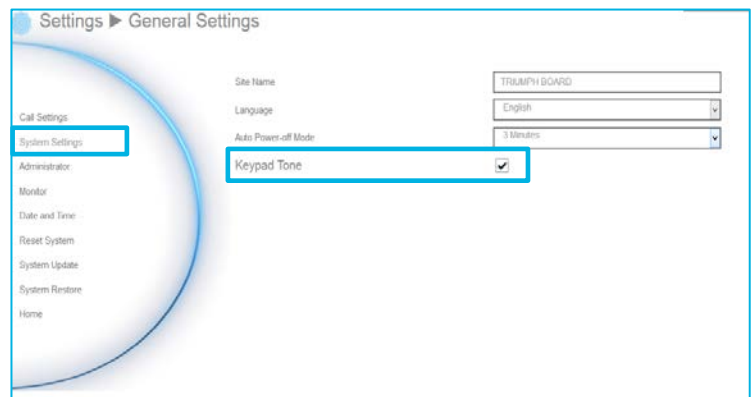

## ADMINISTRATOR

Change Admin. Password

Select General Setting | Administrator and

press .

Here allows you to change Admin. Password.

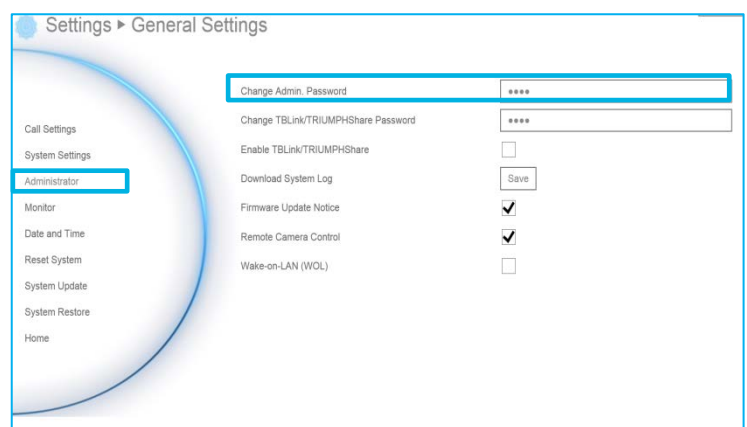

## Save System Log

If you encounter unknown issues and are unsure of how to troubleshoot the unit, sending us the saved system log data to help us solve your problem faster.

Insert a USB Flash drive into the USB Port of the Video Conferencing System VC1 main system. (Either on the front panel or back panel)

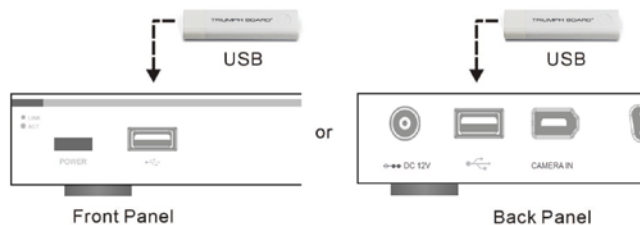

Select **“Run”** located next to **“Save System Log”** to save the system log into your USB Flash drive.

After the file is saved, select **“OK”**. Remove the USB Flash drive and insert it into your computer’s USB port. Located the file message.tar.gz and send it to the TRIUMPH BOARD technical support team.

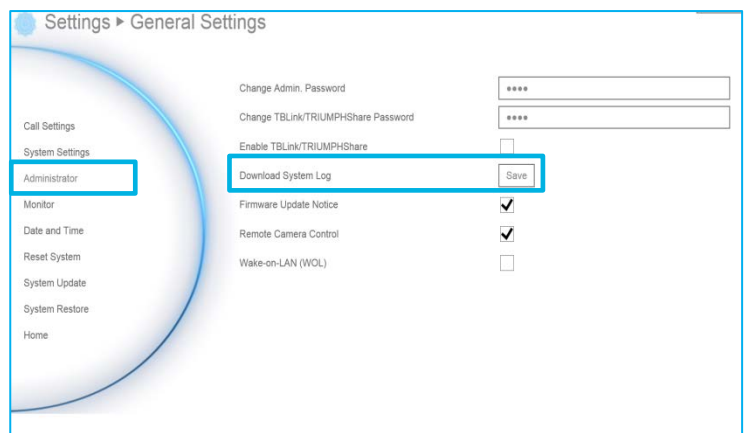
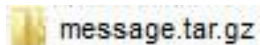

## Firmware Update Notice

Select this function check box to enable firmware updated notice function. By default, this function is enabled.

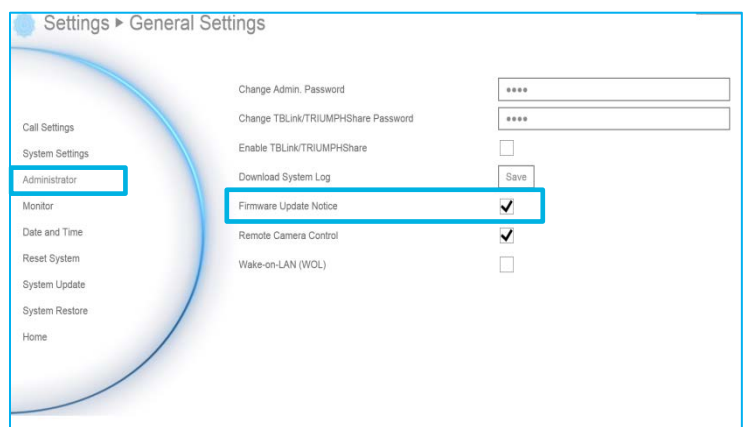

## Remote Camera Control

Select the “**Remote Camera Control**” check box to enable the far site to control your camera. By default, this function is enabled.

The screenshot shows the 'Settings - General Settings' interface. On the left is a navigation menu with 'Administrator' highlighted. The main area contains several settings:

- Change Admin. Password: [password field]
- Change TBLink/TRIUMPHShare Password: [password field]
- Enable TBLink/TRIUMPHShare:
- Download System Log: [Save button]
- Firmware Update Notice:
- Remote Camera Control:  (highlighted with a red box)
- Wake-on-LAN (WOL):

## Wake-On-LAN (WOL)

Wake-on-LAN is an Ethernet computer networking standard that allows your computer to be turned on or awakened by a network message. By default, this function is disabled.

The screenshot shows the 'Settings - General Settings' interface. On the left is a navigation menu with 'Administrator' highlighted. The main area contains several settings:

- Change Admin. Password: [password field]
- Change TBLink/TRIUMPHShare Password: [password field]
- Enable TBLink/TRIUMPHShare:
- Download System Log: [Save button]
- Firmware Update Notice:
- Remote Camera Control:
- Wake-on-LAN (WOL):  (highlighted with a red box)



## MONITOR

Video Conferencing System VC1 main system allows you to connect dual monitor. In the **Monitor** configuration screen, you can configure the **Aspect Ratio** and **Screen Saver** to each monitor.

Select General Setting | Monitor and press

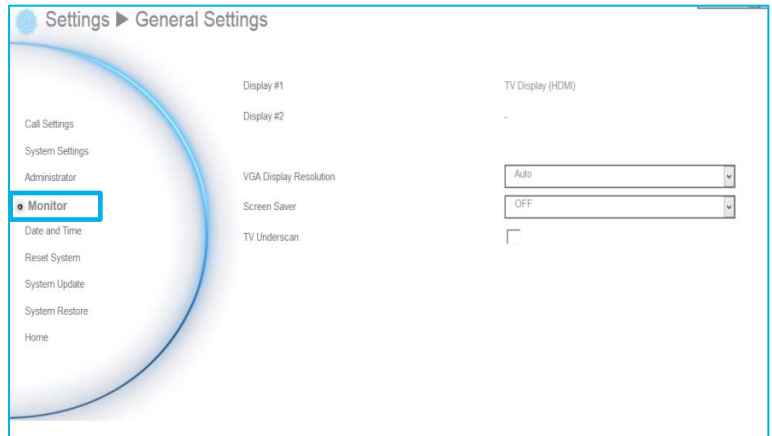

Select the Monitor Aspect Ratio (Auto/4:3/16:9) that you want from the

drop-down list and press . If you want the system to detect the right setting automatically, please select **“Auto”**.

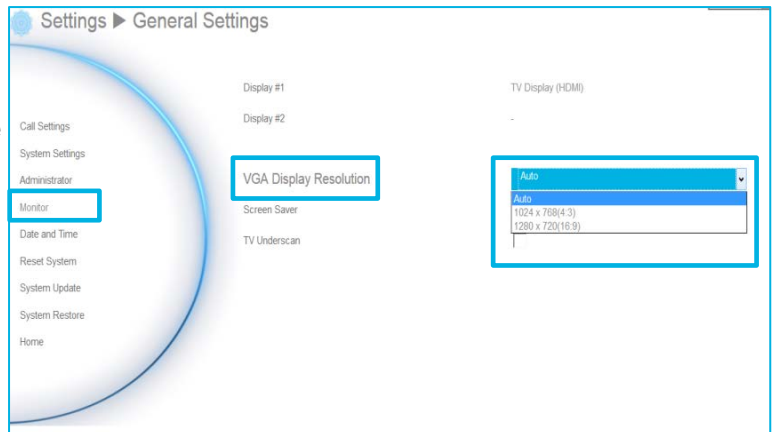

Select the Screen Saver time (OFF/10 Minutes/20Minutes/30Minutes/60Minutes)

from the drop-down list and press . You can select **“OFF”** to disable this function or define a standby mode time.

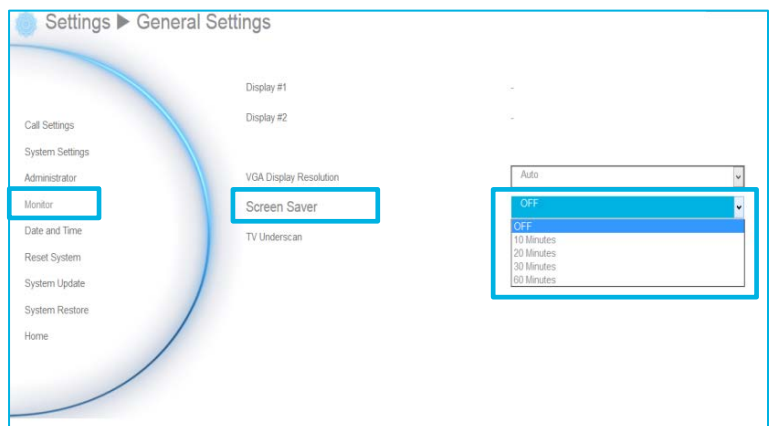

The screen will turn black when the system is in standby mode. Press any button on the remote controller to wake up the system.

## DATE AND TIME

Date and Time allows you to set the Date and Time formats, adjust the time setting and change the Time zones around the world and countries.

### Date Format

Select General Setting | Date and Time and press .

Select the Date Format (yyyy-mm-dd/mm-dd-yyyy/dd-mm-yyyy) you prefer from the drop-down list.

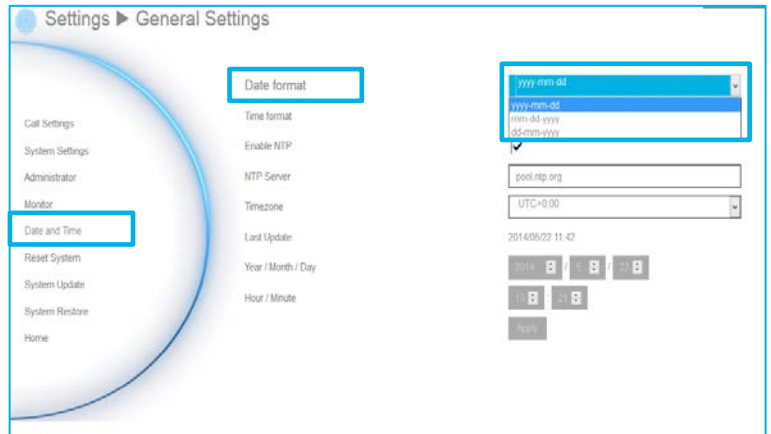

### Time Format

Select General Setting | Date and Time and press .

Select the Time Format (24-hour/12-hour) you prefer from the drop-down list.

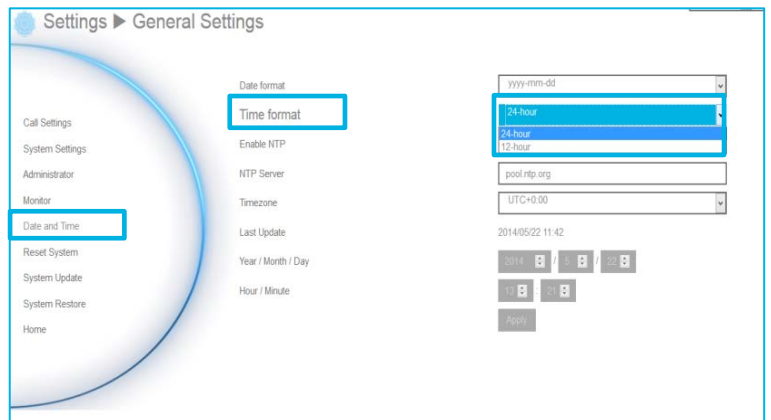

### Enable NTP

Network Time Protocol (NTP) is a protocol that is used to synchronize computer clock times in a network of computers. Select the **Enable NTP** check box to make your computer time the same as the network time.

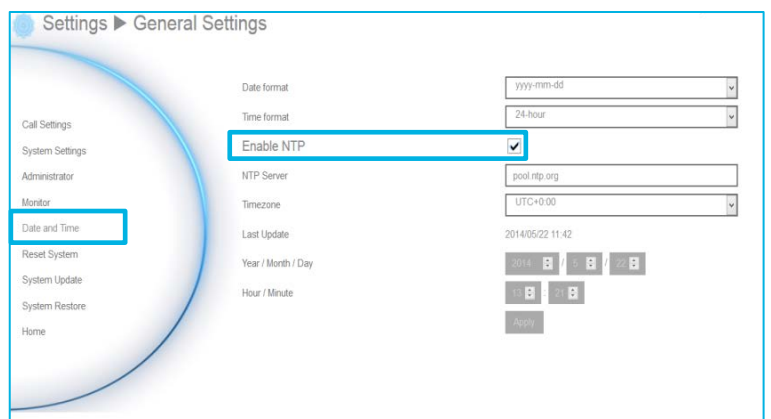

## NTP Server

The Network Time Protocol (NTP) allows administrators to synchronize all network computers to a main server. This keeps all network machine clocks on the same time. Enter the NTP Server name that you want to follow.

The screenshot shows the 'Settings > General Settings' page. On the left sidebar, 'Date and Time' is selected. In the main content area, the 'NTP Server' field is highlighted with a blue box and contains the text 'pool.ntp.org'. Other visible settings include 'Date format' (yyyy-mm-dd), 'Time format' (24-hour), 'Enable NTP' (checked), and 'Timezone' (UTC+0:00). The 'Last Update' field shows '2014/05/22 11:42'.

## Timezone

Timezone allows you to adjust the time when you are in a different country or area so that you can keep the same time with your original area. Most of the time zones on land are offset from Coordinated Universal Time (UTC) by a whole number of hours (UTC-12 to UTC+14).

This screenshot shows the 'Timezone' dropdown menu open. The 'Timezone' label is highlighted with a blue box. The dropdown list contains various UTC offsets from UTC-12:00 to UTC+0:00. The 'UTC+9:00' option is currently selected and highlighted with a blue box.

## Year and Hour

Enter the date and time including year, month, day, hour and minute that you want to show on the present system.

The screenshot shows the 'Date and Time' section of the settings page. The 'Date and Time' label is highlighted with a blue box. Below it, the 'Year / Month / Day' field is highlighted with a blue box and contains '2014', '5', and '29'. The 'Hour / Minute' field is also highlighted with a blue box and contains '13' and '18'. An 'Apply' button is visible below these fields.

Select **“Apply”** to active your settings.

This screenshot shows the final state of the settings page. The 'Apply' button at the bottom right is highlighted with a blue box, indicating that the user should click it to save the changes.

## RESET SYSTEM

The Reset System allows you to reset your main system to factory settings, which will clear phonebook entries and call history. Make sure to back up the information before resetting the system.

**Default Setting Reset:** LAN configuration, video/audio codec selection, call settings and so on will be reset. Click “Yes” to reset your system to factory default values.

**Clear Phonebook:** All the phonebook entries saved in the system will be deleted. Click “Yes” to clear all content of your phonebook.

**Clear Call History:** All the incoming and outgoing call records will be deleted. Click “Yes” to delete all calling information of the call history.

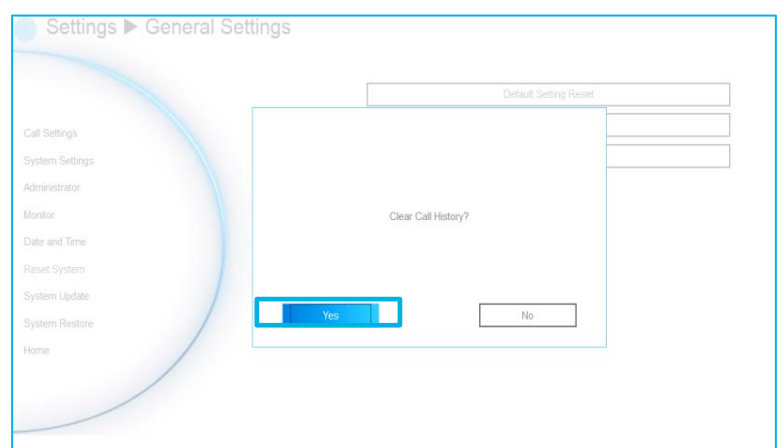
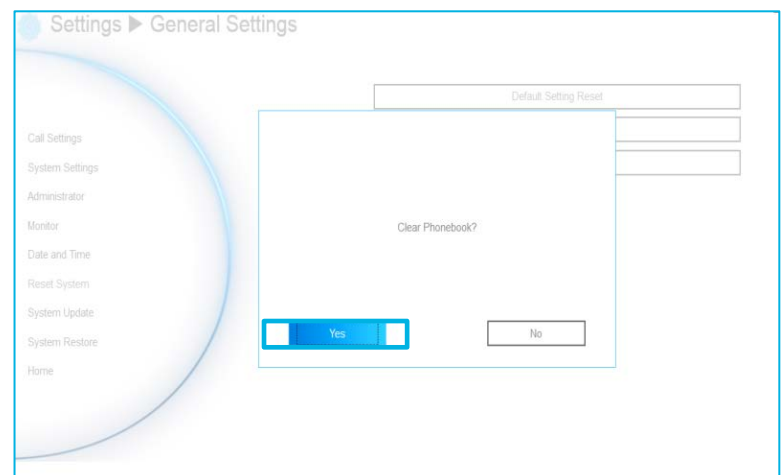
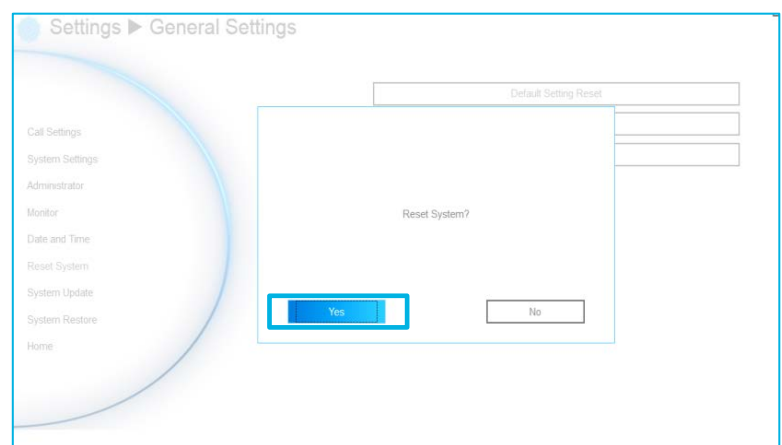
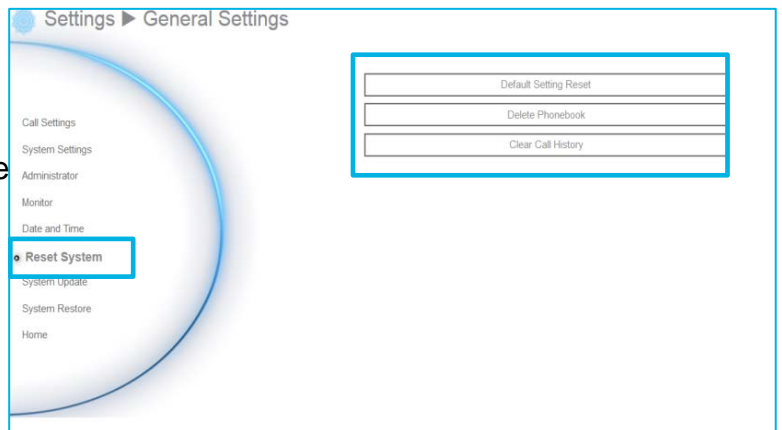

## Video/Audio

In **Video/Audio** configuration screen, you can set the MIC gain level, select the preferred video and audio codecs and adjust the camera functions.

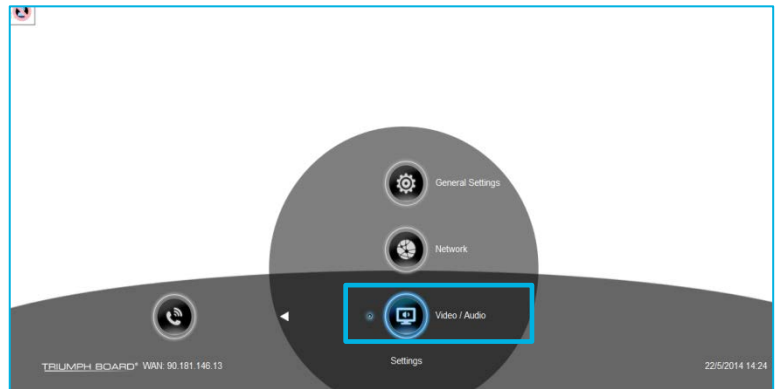

### CAMERA

Camera allows you to set the **White Balance**, **Exposure** and **Frequency** for your camera.

#### White Balance

Whit balance is a camera setting that adjusts for lighting in order to make white objects appear white in photos.

Select **Video/Audio** | **Camera** and press



Select the **White Balance type** from the drop down list. Video Conferencing System VC1 main system supports up to 5 types of white balance for your selection.

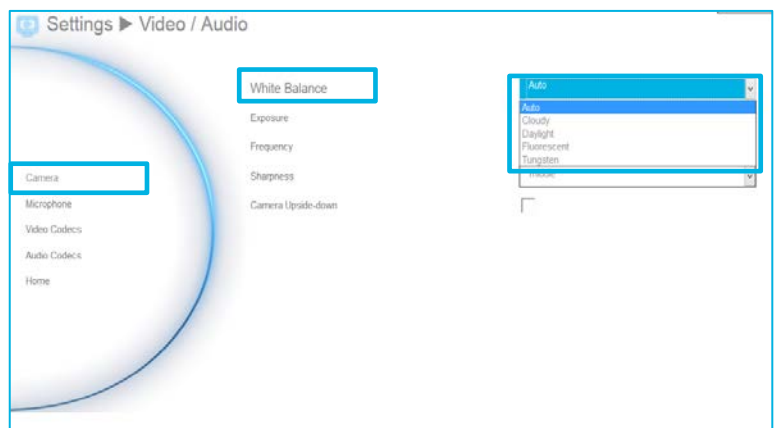

**Auto:** Most cameras default to automatic white balance. It makes white objects bright white and alter all the other colors to match.

**Cloudy:** You can use the **Cloudy** white balance setting instead of auto on a cloudy day. This allows the camera to compensate for blueness in the shadows, warming up the scene to better match what your eye would see.

**Daylight:** You can use **Daylight** settings only when shooting in very bright sunlight, as it can produce blueish results on overcast days.

**Fluorescent:** You can use **Fluorescent** setting to cancel out the green or blue cast, which can produce sickly-looking results on human skin.

**Tungsten:** This setting assumes a color temperature of around 3,200k and is suitable for most tungsten lamps that normally emit a yellow light. This is usually used to correct for the same color cast.

## Exposure

A photograph's exposure determines how light or dark an image will appear when it is been captured by your camera. Select the exposure level you prefer from 1 to 9 or auto.

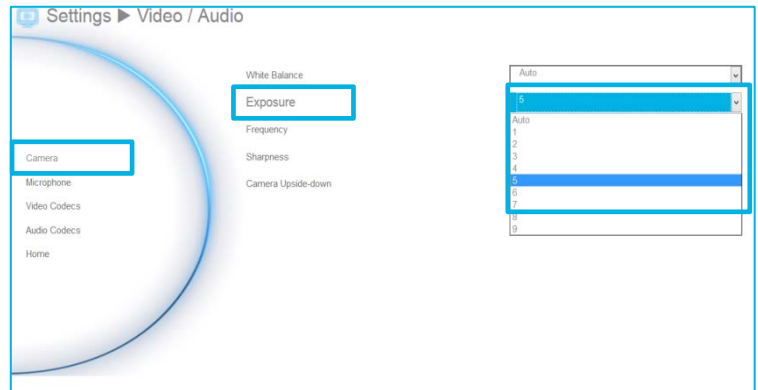

## Frequency

Select the correct frequency setting (Auto/50Hz/60Hz/OFF) from the Frequency drop-down list.

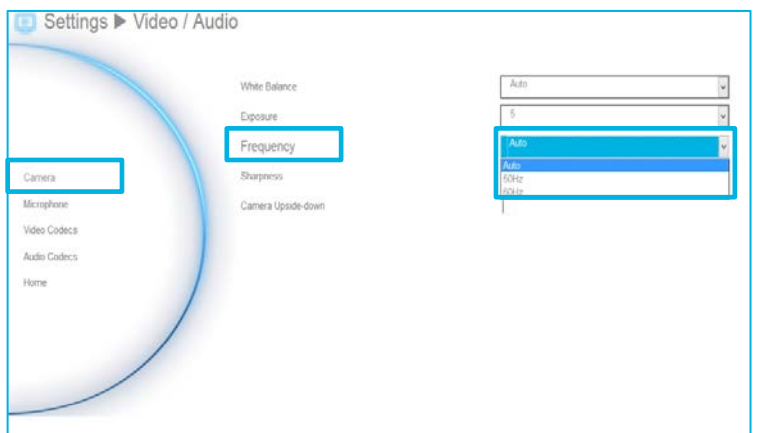

## Sharpness

Sharpness is the crispness or blur of boundaries between zones of different tones or colors. Boundaries in a sharp image are crisp steps. On the other hand, image with low sharpness give blurred, gradually-changing boundaries. Select the Sharpness level among High/Medium/Low that best fits your preference or simply turn off the Sharpness option.

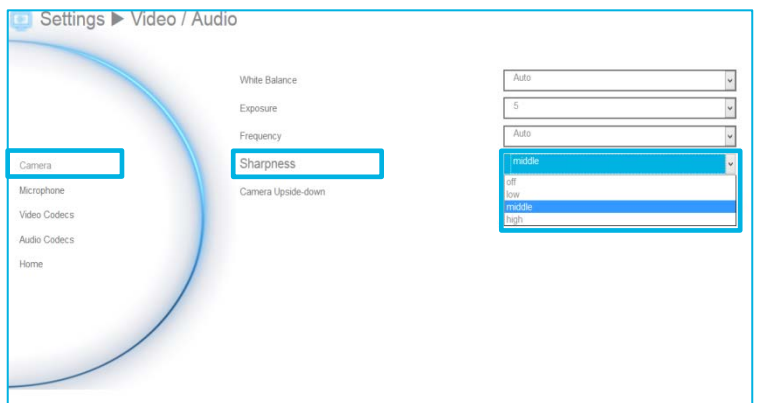

## Camera Upside-down

When camera is handed at up-side-down position, enable Camera Upside-down to flip the image view.

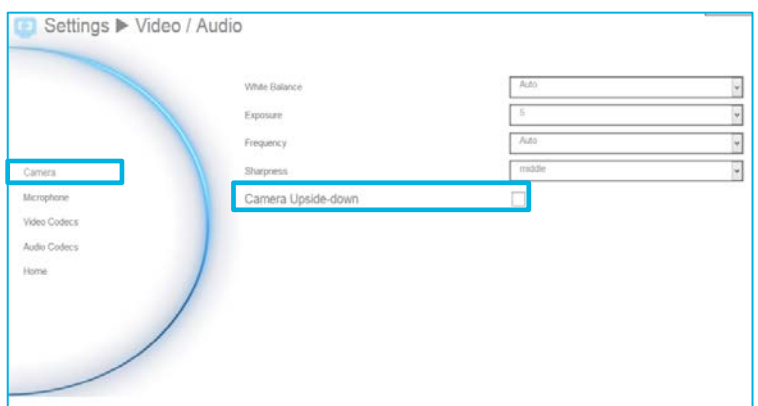

## MICROPHONE

Video Conferencing System VC1 main system allows you to adjust the **MIC Gain Level** up to 9 for proper MIC volume to improve audio reception on the microphone (s).

### MIC Gain Level

Select Video/Audio | Microphone and press



Adjust the **MIC Gain Level** form the drop-down list.

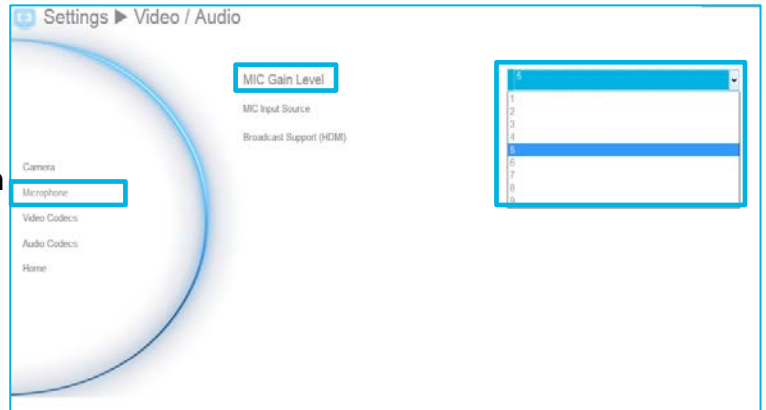

### MIC Input Source

Select the source of the MIC from the MIC in or Audio in. If you connect a MIC in AUDIO IN port, we recommend selecting Audio in selection to avoid the echo issue.

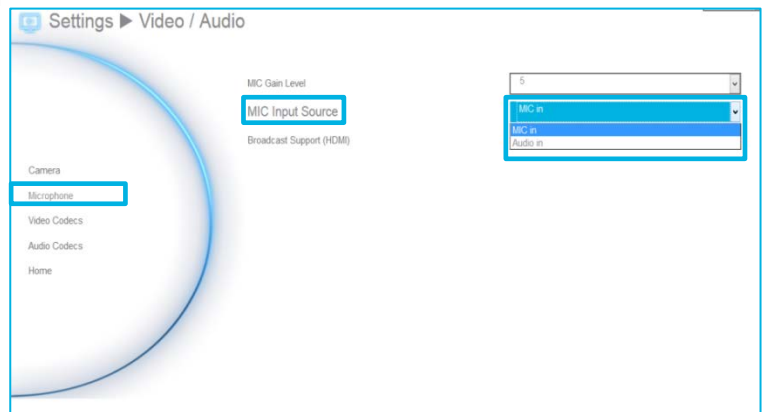

## VIDEO/AUDIO CODECS

You can specify the **Video/Audio Codecs** in **Video Codecs** and **Audio Codecs** configuration screens.

Select **Video/Audio | Video Codecs** for Video Codecs configuration or **Video/Audio | Audio Codecs** for Audio Codecs configuration and press  .

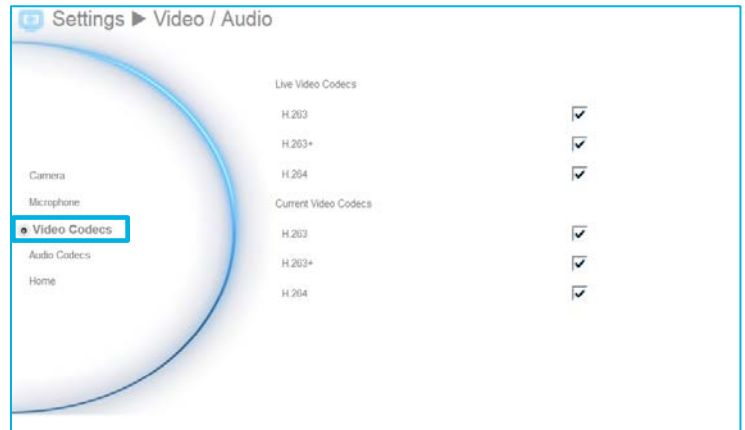

Select the **Video/Audio Codecs** to specify the codecs you want to support. While the TRIUMPH BOARD Video Conferencing System VC1 supports the H.323 standard coding algorithm, each codec has unique properties and performs best given a certain set of circumstances.

**For Video:** H.264, H.263+, H.263

**For Audio:** G.728, G.722.1C, G.722.1, G.722, G.711

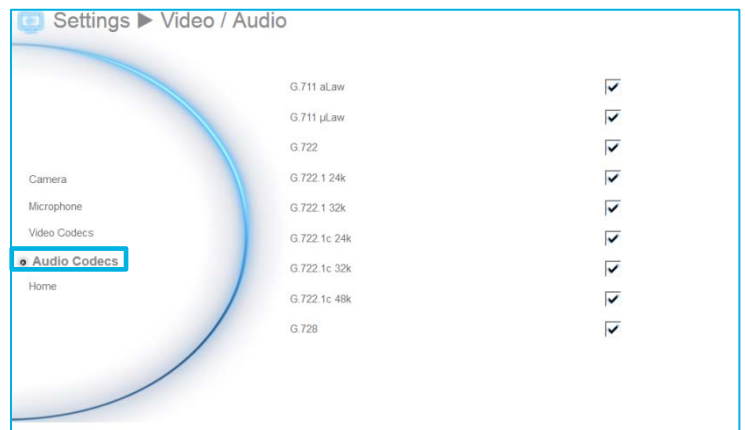

---

 Please contact system administrator if you have any question on these codecs.

---



# Network

**Network** allows you to set the **SIP Server, Gatekeeper, Firewall and LAN Configurations**. Before configuring Network and Firewall, please refer to page 69 – Scenarios for LAN connection and follow the instructions of your actual network connection scenario.

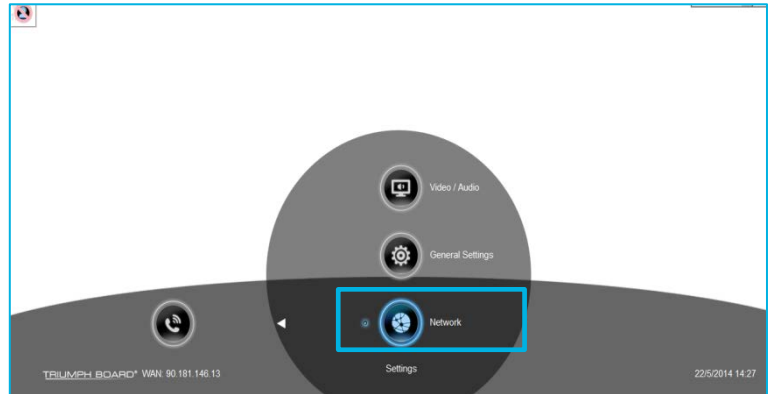

## LAN CONFIGURATION

TRIUMPH BOARD Video Conferencing System VC1 supports **IPv4** and **IPv6** internet protocol for your configuration. IPv4 is the most widely deployed internet protocol used to connect devices to the internet. IPv4 uses a 32-bit address scheme, written in decimal as four numbers separated by periods. Each number can be zero to 255. For example, 192.168.0.1 could be an IP address.

Select Network | LAN Configuration and press



Configure the following relative items to setup the LAN Configuration.

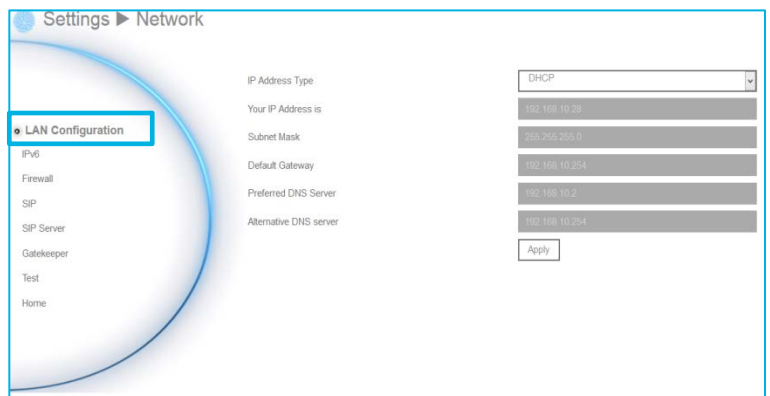

## IP Address Type

**DHCP:** Configure the system to automatically obtain an IP address from the DHCP server.

**Static IP:** Configure the system to use the assigned IP address. Select this when the public IP address is available.

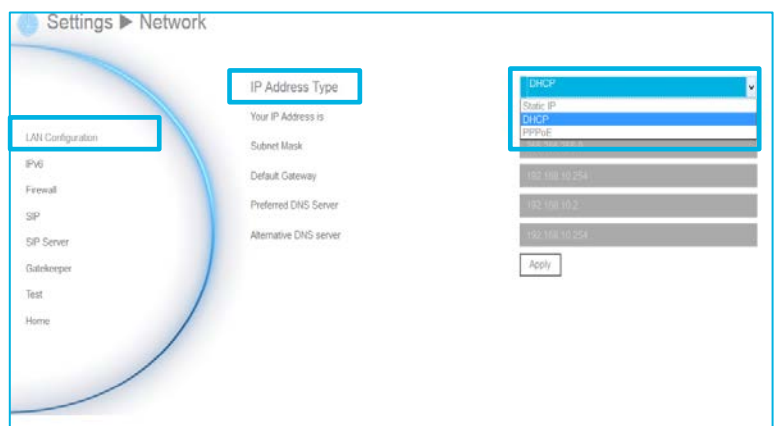

## Your IP address is

Show the current IP address; enter into when you need to configure your IP address manually.

Settings > Network

IP Address Type: PPPoE

Your IP Address is: 192.168.10.28

Subnet Mask: 255.255.255.0

Default Gateway: 192.168.10.254

Preferred DNS Server: 192.168.10.2

Alternative DNS server: 192.168.10.254

Apply

## Subnet Mask

Show the designated IP address routing prefix; enter the subnet mask address when the system does not automatically obtain the subnet mask

Settings > Network

IP Address Type: PPPoE

Your IP Address is: 192.168.10.28

Subnet Mask: 255.255.255.0

Default Gateway: 192.168.10.254

Preferred DNS Server: 192.168.10.2

Alternative DNS server: 192.168.10.254

Apply

## Default Gateway

A gateway is a network point that acts as an entrance to another network. Enter the gateway address when the system does not automatically obtain the gateway.

Settings > Network

IP Address Type: PPPoE

Your IP Address is: 192.168.10.28

Subnet Mask: 255.255.255.0

Default Gateway: 192.168.10.254

Preferred DNS Server: 192.168.10.2

Alternative DNS server: 192.168.10.254

Apply

## Preferred/Alternate DNS Server

Domain Name System (DNS) servers convert human friendly names (for example: www.example.com) to IP addresses (218.77.272.166) that let machines be found on the network. The preferred DNS server is the one your computer asks first. The alternate is a backup. Enter the Preferred and Alternated DNS Server address.

The screenshot shows the 'Settings > Network' interface. On the left, a sidebar menu has 'LAN Configuration' highlighted with a blue box. The main area shows the following settings:

- IP Address Type: PPPoE
- Your IP Address is: 192.168.10.20
- Subnet Mask: 255.255.255.0
- Default Gateway: 192.168.10.254
- Preferred DNS Server: 192.168.10.2
- Alternative DNS server: 192.168.10.254

An 'Apply' button is located at the bottom right of the settings area.

After finishing all settings, select **“Apply”** to active the changed settings.

This screenshot is identical to the previous one, but the 'Apply' button at the bottom right is highlighted with a blue box, indicating the final step in the configuration process.

## LAN CONFIGURATION (IPV6)

IPv6 is an evolutionary upgrade to the Internet Protocol. IPv6 will coexist with the older IPv4 for some time. IPv6 addresses are 128-bit IP address written in hexadecimal and separated by colons. An example IPv6 address could be written like this: 300E:1389:3030:72EB:1D71:414B:1079:6AF3. Some types of addresses contain long sequences of zeroes that can be compressed (the address of fc00:0000:0000:0000:0000: 0000:0000:0001 can be compressed to fc00::1).

Select Network | LAN Configuration (IPv6) and press  .

Configure the following relative items to setup the LAN Configuration (IPv6).

The screenshot shows the 'Settings > Network' interface with 'IPv6' selected in the sidebar menu. The main area shows the following settings:

- IP Address Type: Static IP
- Your IP Address is: fc00:1
- Prefix Length: 7

An 'Apply' button is located at the bottom right of the settings area.

## IP Address Type

**Static IP:** Configure the system to use the assigned IP address. Select this when the public IP address is available.

**Auto:** Obtain the dynamic IP address automatically.

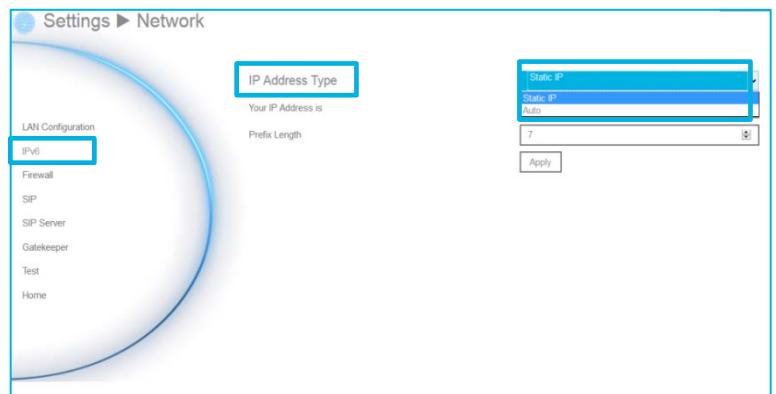

## Your IP Address is

Show the current IP address; enter into when you need to configure your IP address manually.

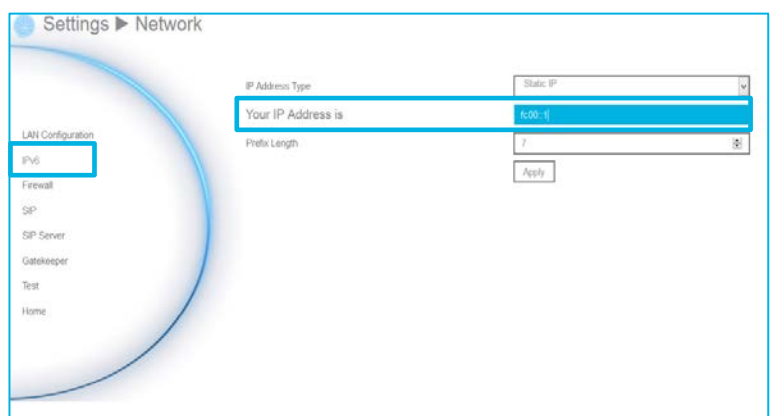

## Prefix Length

Prefix Length allows you to place as many IPv6 devices as the underlying network medium allows.

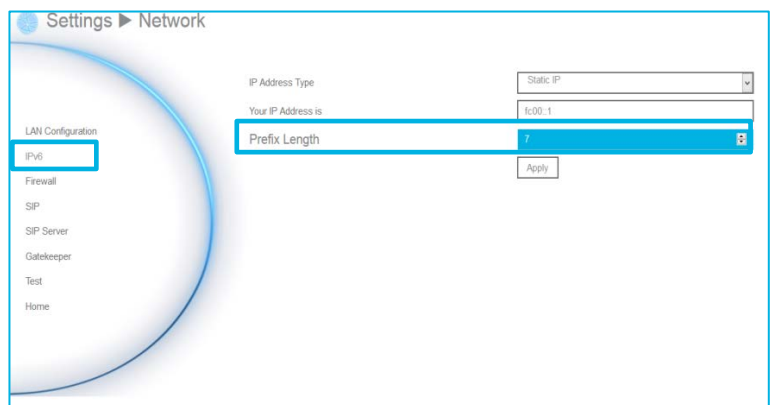

After finishing all settings, select **“Apply”** to activate the changed settings.

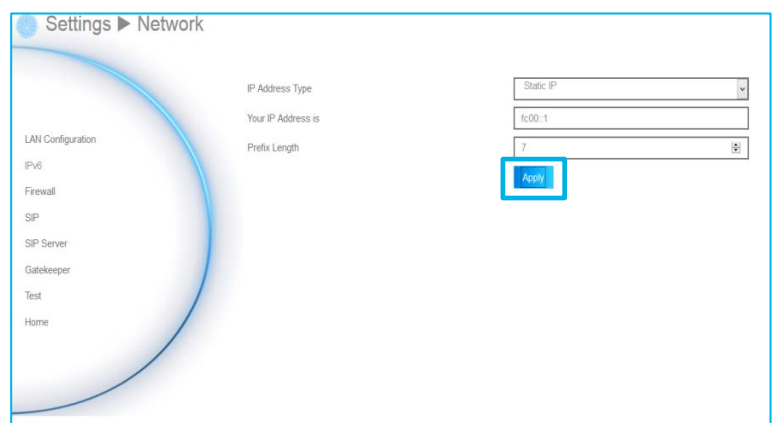

## FIREWALL

Configure the following items to setup the Firewall.

Select **Network | Firewall** and press  .  
Configure the following relative items to setup the Firewall.

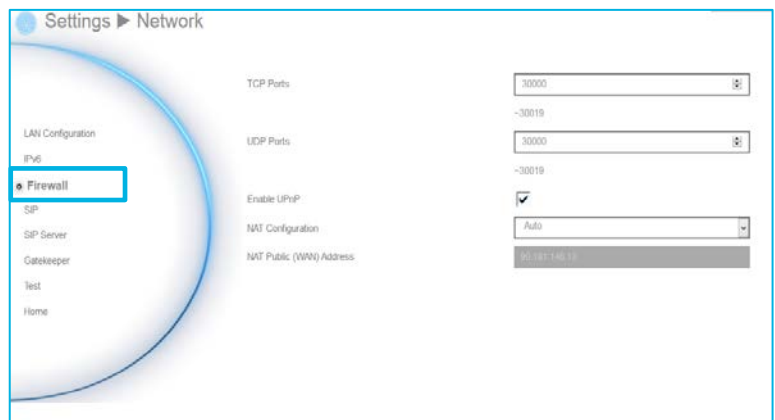

## TCP/UDP Ports

By default, the system communicates through TCP/UDP ports in the range from 30000 to 30019. You can specify the range for your specific network environment.

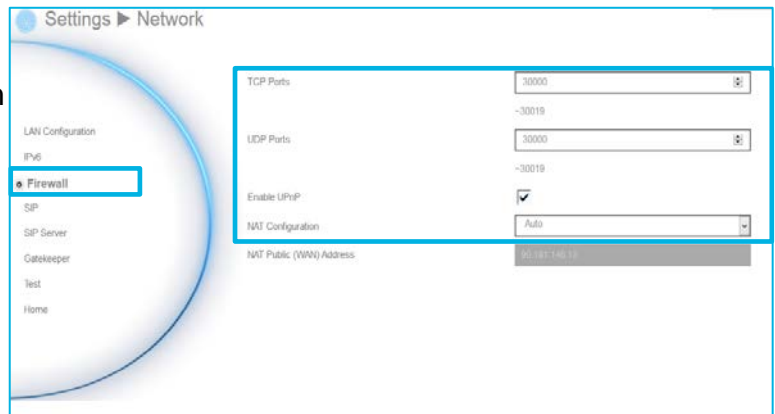

 You must configure your firewall to allow inbound/outbound traffic through TCP ports 1720/1719 for H.323 call setup.

## NAT Configuration

TRIUMPH BOARD Video Conferencing System VC1 supports NAT systems that use the internal IP addresses to communicate with other devices outside the LAN.



## NAT Public (WAN) Address

The NAT public address must be entered when you enable the feature on NAT configuration.

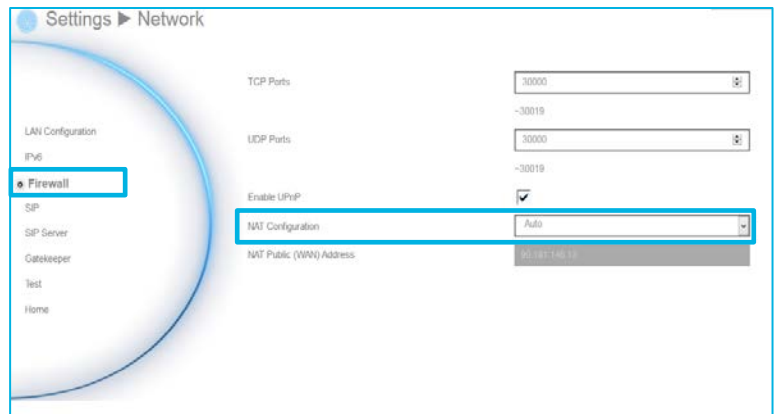

## SIP

Session Initiation Protocol (SIP) allows you around the world to communicate using your supported devices over the Internet.

Select **Network** | **SIP** and press .

Configure the following relative items to setup the SIP.

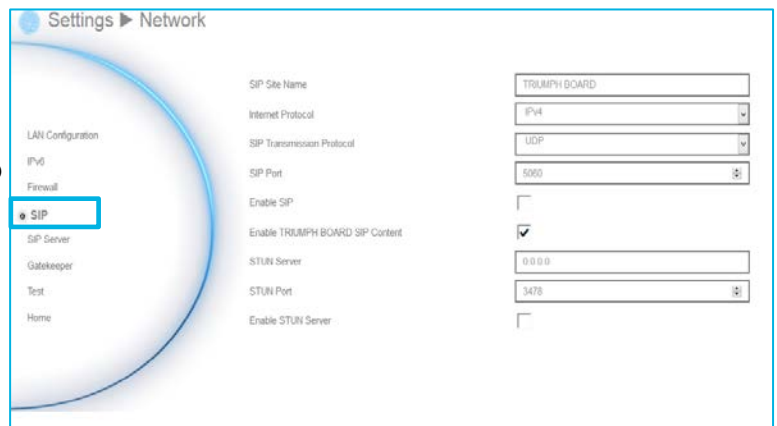

## SIP Site Name

Enter the SIP site name for others to identify. The SIP site name may be the same or different than the domain for Web activity.

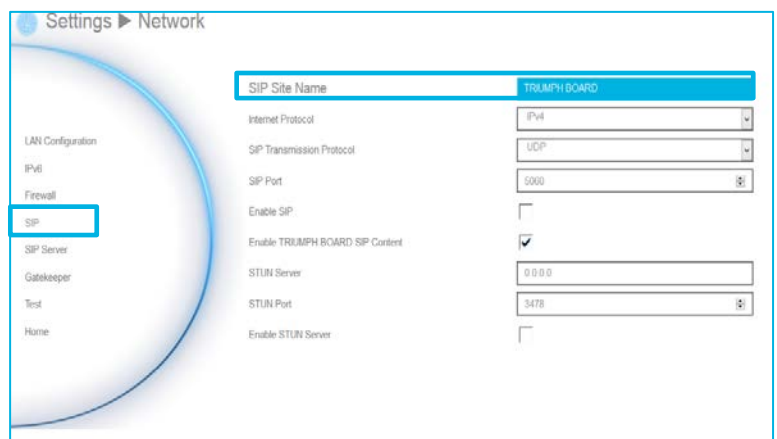

## Internet Protocol

Select internet protocol check box to enable IPv4 or IPv6 protocol using.

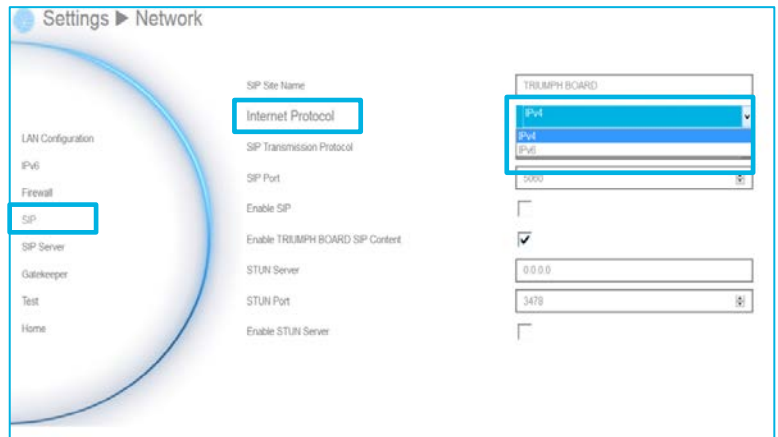

## SIP Transport Protocol

Select the SIP Transport Protocol type from the drop-down list for using. There are two types of Internet Protocol (IP) traffic. They are Transmission Control Protocol (TCP) and User Datagram Protocol (UDP). To ensure proper connection, verify if both calling parties are using the same transport protocol. By default, it is set to UDP.

**TCP:** TCP is connection oriented. Once a connection is established, data can be sent bidirectional.

**UDP:** UDP is a simpler, connectionless Internet protocol. Multiple messages are sent as packets in chunks using UDP.

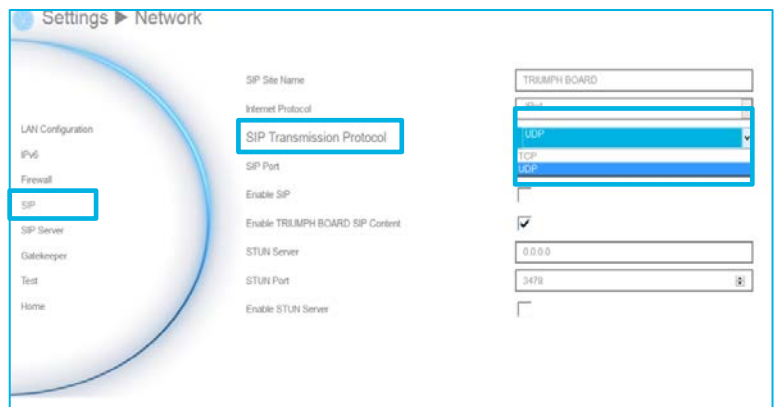

## SIP Port

Change this value only if you use specific settings in your network system. By default, the SIP port is set to 5060.

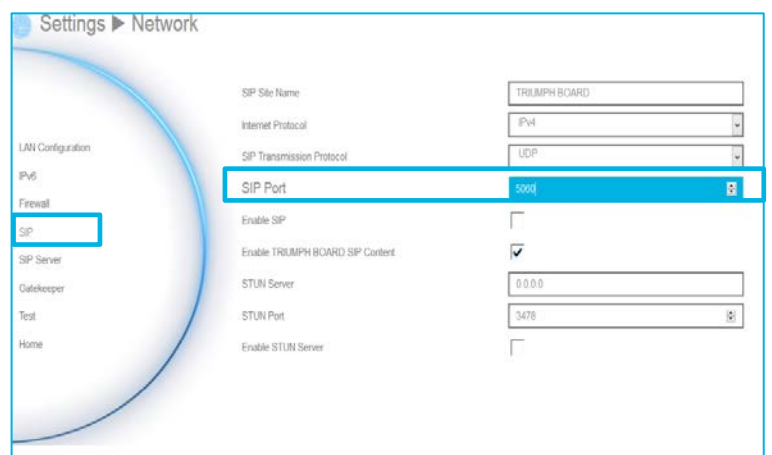

## Enable SIP

Select Enable SIP check box and press to activate/deactivated using SIP.



Settings > Network

LAN Configuration

IPv6

Firewall

**SIP**

SIP Server

Gatekeeper

Test

Home

SIP Site Name: TRIUMPH BOARD

Internet Protocol: IPv4

SIP Transmission Protocol: UDP

SIP Port: 5000

**Enable SIP**

Enable TRIUMPH BOARD SIP Content:

STUN Server: 0.0.0.0

STUN Port: 3478

Enable STUN Server:

## STUN Server

STUN (Session Traversal Utilities for NAT) is a standardized set of methods and a network protocol to allow an end host to discover its public IP address if it is located behind a NAT.

Enter IP address of SIP NTA traversal server.

Settings > Network

LAN Configuration

IPv6

Firewall

**SIP**

SIP Server

Gatekeeper

Test

Home

SIP Site Name: TRIUMPH BOARD

Internet Protocol: IPv4

SIP Transmission Protocol: UDP

SIP Port: 5000

Enable SIP:

Enable TRIUMPH BOARD SIP Content:

**STUN Server**: 0.0.0.0

STUN Port: 3478

Enable STUN Server:

## STUN Port

Enter port number of STUN server.

Settings > Network

LAN Configuration

IPv6

Firewall

**SIP**

SIP Server

Gatekeeper

Test

Home

SIP Site Name: TRIUMPH BOARD

Internet Protocol: IPv4

SIP Transmission Protocol: UDP

SIP Port: 5000

Enable SIP:

Enable TRIUMPH BOARD SIP Content:

STUN Server: 0.0.0.0

**STUN Port**: 3478

Enable STUN Server:



## Enable STUN Server

Mark to enable STUN server function.

Settings > Network

LAN Configuration  
IPv6  
Firewall  
**SIP**  
SIP Server  
Gatekeeper  
Test  
Home

SIP Site Name: TRIUMPH BOARD  
Internet Protocol: IPv4  
SIP Transmission Protocol: UDP  
SIP Port: 5060  
Enable SIP:   
Enable TRIUMPH BOARD SIP Content:   
STUN Server: 0.0.0.0  
STUN Port: 3478  
**Enable STUN Server:**

## SIP SERVER

A typical SIP session involves a client requesting a session with a SIP server. After the request is received, the SIP server returns a response to the user indicating the availability of the session.

Select Network | SIP Server and press .

Configure the following relative items to setup the Server.

Settings > Network

LAN Configuration  
IPv6  
Firewall  
SIP  
**SIP Server**  
Gatekeeper  
Test  
Home

User Name:   
Authorization Name: TRIUMPH BOARD  
Password:   
Registration Server:   
Proxy Server:   
Account Active:

## User Name

Select Terminal Name and press  to enter user name.

Settings > Network

LAN Configuration  
IPv6  
Firewall  
SIP  
**SIP Server**  
Gatekeeper  
Test  
Home

**User Name:**   
Authorization Name: TRIUMPH BOARD  
Password:   
Registration Server:   
Proxy Server:   
Account Active:

## Authorization Name

Select Terminal Name and press  to enter authorization name.

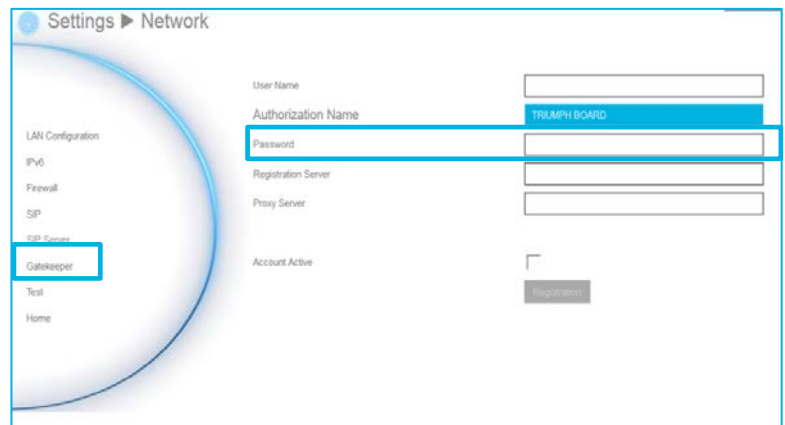

Settings > Network

LAN Configuration  
IPv6  
Firewall  
SIP  
SIP Server  
Gatekeeper  
Test  
Home

User Name  
Authorization Name: TRIUMPH BOARD  
Password  
Registration Server  
Proxy Server  
Account Active

Registration

## Password

Select Password and press  to enter using password.

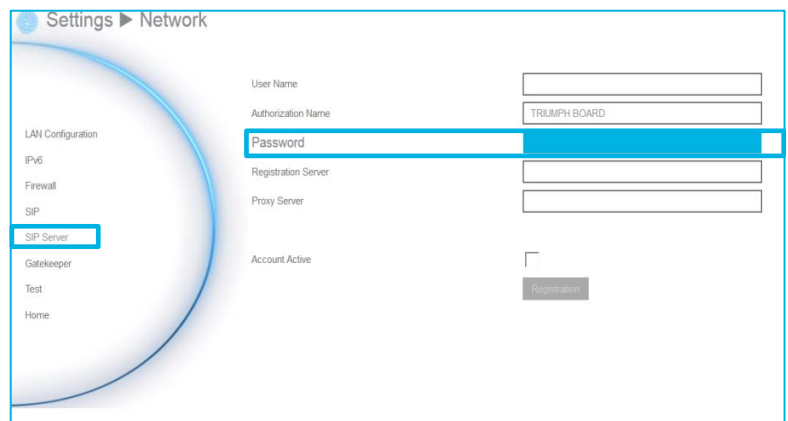

Settings > Network

LAN Configuration  
IPv6  
Firewall  
SIP  
SIP Server  
Gatekeeper  
Test  
Home

User Name  
Authorization Name: TRIUMPH BOARD  
Password  
Registration Server  
Proxy Server  
Account Active

Registration

## Registration Server

Registration Server accepts registrations from users and places these registrations, (which is essentially location information), in a database known as a location service. Enter the Registrar Server name that you want to use.

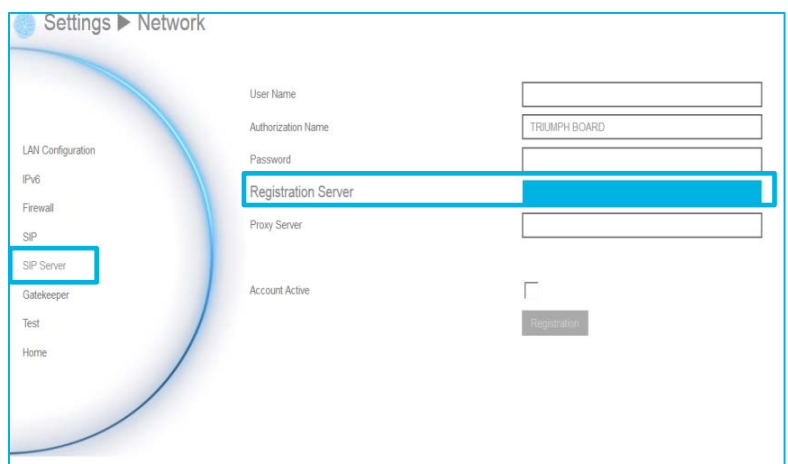

Settings > Network

LAN Configuration  
IPv6  
Firewall  
SIP  
SIP Server  
Gatekeeper  
Test  
Home

User Name  
Authorization Name: TRIUMPH BOARD  
Password  
Registration Server  
Proxy Server  
Account Active

Registration

## Proxy Server

Proxy Server is computing device (typically a server) that interfaces between data processing devices and others within a communications network. These devices may be located on the same local area network or an external network. Enter the used Proxy Server name.

The screenshot shows the 'Settings > Network' configuration page. On the left, a navigation menu includes LAN Configuration, IPv6, Firewall, SIP, SIP Server (highlighted with a red box), Gatekeeper, Test, and Home. The main content area has several fields: User Name, Authorization Name (containing 'TRIUMPH BOARD'), Password, Registration Server, Proxy Server (highlighted with a red box), and Account Active (with an unchecked checkbox). A 'Registration' button is located at the bottom right.

## Account Active

Select Use Registrar check box and press  to activate/deactivated using Registrar.

The screenshot shows the 'Settings > Network' configuration page. The 'SIP Server' option in the left menu is highlighted with a red box. In the main content area, the 'Account Active' checkbox is highlighted with a red box. The 'Proxy Server' field is now empty. The 'Registration' button is visible at the bottom right.

## GATEKEEPER

The **Gatekeeper** in TRIUMPH BOARD Video Conferencing System VC1 serves the purpose of translating services for mE.164IDs to IP addresses in an H.323 network.

Select Network | Gatekeeper and press



. Configure the following relative items

to setup the Gatekeeper.

### H.323 Name

Specify the name that gatekeepers and gateways can use to identify this system. Enter the name; the gatekeeper will use this name for identification.

### H.323 Extension

Enter a numeric value for the gatekeeper to identify your system further.

## Gatekeeper IP Address

Enter the IP address for the gatekeeper server.

The screenshot shows the 'Settings > Network' interface. On the left, a sidebar menu includes 'LAN Configuration', 'IPv6', 'Firewall', 'SIP', 'SIP Server', 'Gatekeeper', 'Test', and 'Home'. The 'Gatekeeper' option is highlighted with a blue box. The main content area shows the following fields: 'H.323 Name' (TRIUMPH BOARD), 'H.323 Extension' (0), 'Gatekeeper IP Address' (0.0.0.0), 'Connect to Gatekeeper' (checkbox), and 'Enable H.460 Firewall Traversal' (checkbox). The 'Gatekeeper IP Address' field is highlighted with a blue box.

## Connect to Gatekeeper

Select this check box to Activate/deactivate gatekeeper.

The screenshot shows the 'Settings > Network' interface. The 'Gatekeeper' option in the sidebar is highlighted. The 'Connect to Gatekeeper' checkbox is highlighted with a blue box. The other fields are the same as in the previous screenshot.

☞ Make sure to setup the Gatekeeper before setting up the Firewall.

## Enable H.460 Firewall Traversal

If you want to enable the H.460 Firewall Traversal, please set the following ports in port forwarding in your firewall before start installing your Video Conferencing System VC1.

The screenshot shows the 'Settings > Network' interface. The 'Enable H.460 Firewall Traversal' checkbox is highlighted with a blue box. The other fields are the same as in the previous screenshots.

☞ Make sure your gatekeeper supports H.460 Firewall Traversal before enabling it.

## Web Configurations

You can use the internet browser to access your TRIUMPH BOARD Video Conferencing System VC1 through a LAN RJ-45 cable to setup a TRIUMPH BOARD Video Conferencing System VC1 remotely. You can also access the Phonebook to add, edit and delete entries, view and download the call history, update the system, and restore your previous settings. For web configurations, your TRIUMPH BOARD Video Conferencing System VC1 default IP address is: 192.68.0.1.

☞ Please change your Video Conferencing System VC1's IP address at the start.

## Using the WebTool

Enter your Video Conferencing System VC1's IP address in the URL field. Enable Web Admin setting must be activated and your will need to enter admin password to long in.

In WebTool login screen, user can select the Language of WebTool and enter the password, click Submit button to login.

☞ Default password is 1234

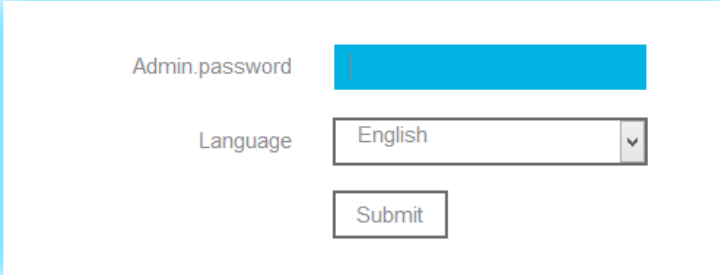

The screenshot shows a login form with the following elements:

- A text input field labeled "Admin.password" containing a blue bar representing a password.
- A dropdown menu labeled "Language" with "English" selected.
- A "Submit" button.

After login, user should see the video screen of local site.

In the WebTool page, you can access the following:

1. Phonebook
2. Dial
3. Call History
4. Video/Audio
5. General Setting
6. Network

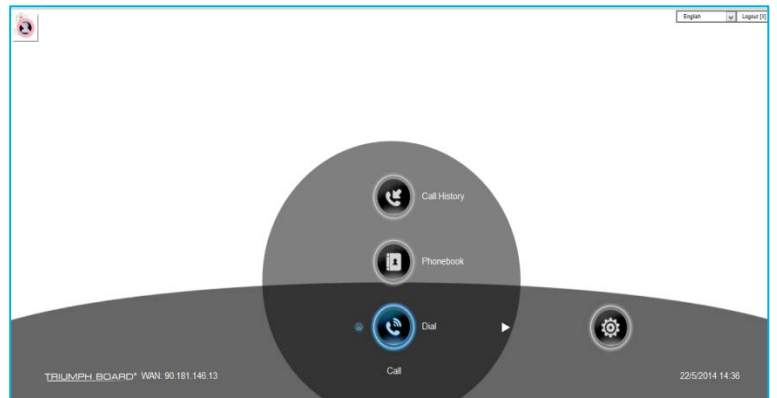

☞ You can use the mouse to click the specified icon for a selection.

## Managing Phonebook

In the Phonebook page of WebTool, all functions are the same as your TRIUMPH BOARD Video Conferencing System VC1 Application. One different is the Upload/Download.

### EDIT AND SAVE

1. Locate and open the file using MS Excel and select Office XML Handler to create a schema based on the XML source data.



2. Edit the file.

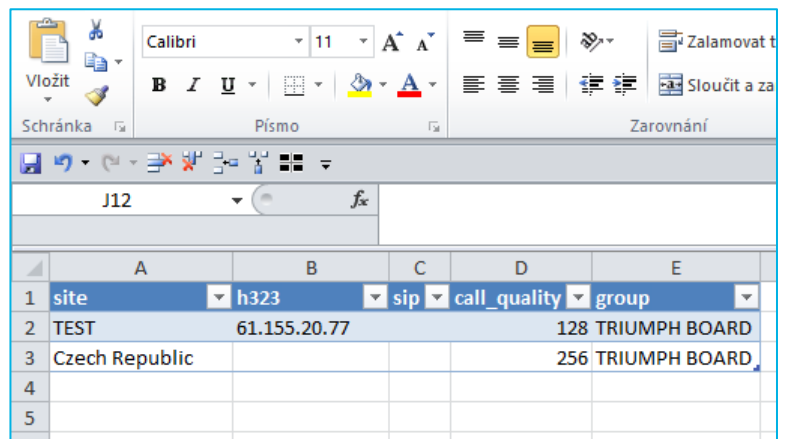

3. Make sure to save the file as XML Data so it can be uploaded back to the system.

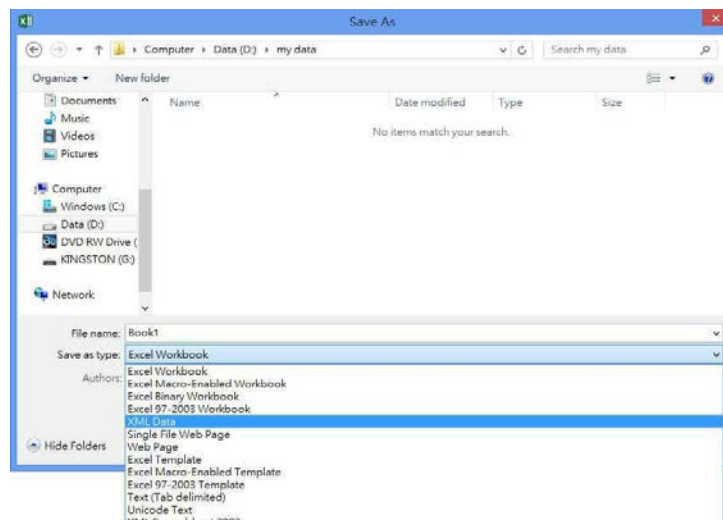



## DOWNLOAD PHONEBOOK ENTRIES

Download allows you to download contact data from your TRIUMPH BOARD Video Conferencing System VC1.

1. Click Phonebook | Upload/Download.

2. The saving Phonebook data from TRIUMPH BOARD VC1 system dialogue box will appear,

3. Click "Save" to save the file.

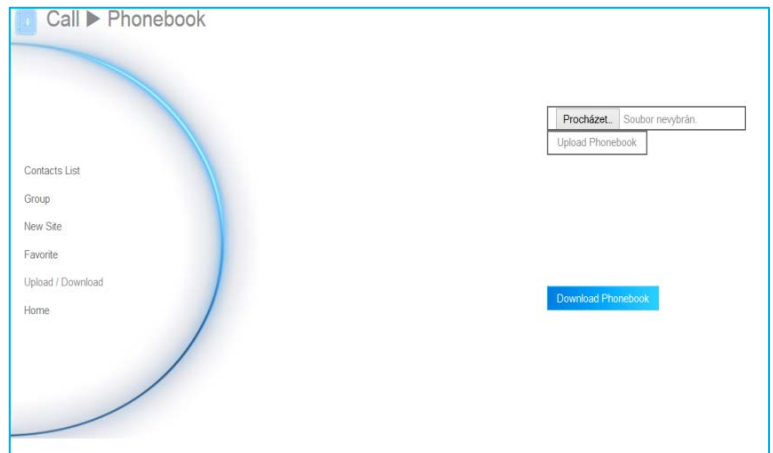

4. After saving, you have to re-arrange your browser to update your WebTool Phonebook so that it can be the same as your Video Conferencing System VC1.

## UPLOAD PHONEBOOK ENTRIES

Upload allows you to upload the data that you have edited or added from your WebTool to your TRIUMPH BOARD Video Conferencing System VC1.

1. Click Phonebook | Upload/Download

2. Click "Upload Phonebook" to upload edited or added contents to your TRIUMPH BOARD VC1 system directly.

3. You can also click "Browser" to open the Phonebook file .xml saved in your PC to upload it to your TRIUMPH BOARD Video Conferencing System VC1.

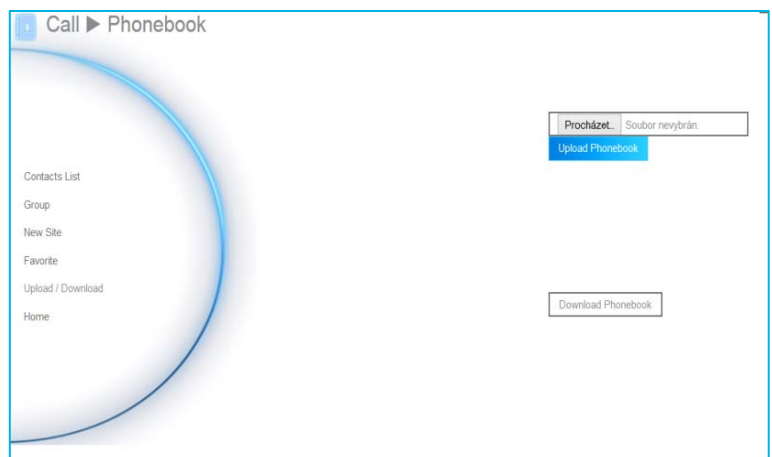

4. After completing upload, the contents of Phonebook on your TRIUMPH BOARD Video Conferencing System VC1 will be modified in time.

---

☞ You can also download the phonebook entries and upload them to another TRIUMPH BOARD Video Conferencing System VC1 unit.

---

## Update System

You can update the latest Video Conferencing System VC1 firmware to your TRIUMPH BOARD Video Conferencing System VC1 from TRIUMPH BOARD Video Conferencing System VC1 WebTool.

1. Click General Setting | System Update

2. Click "System Update".

3. Click "**Select**" to browse and locate the downloaded firmware file .dat.

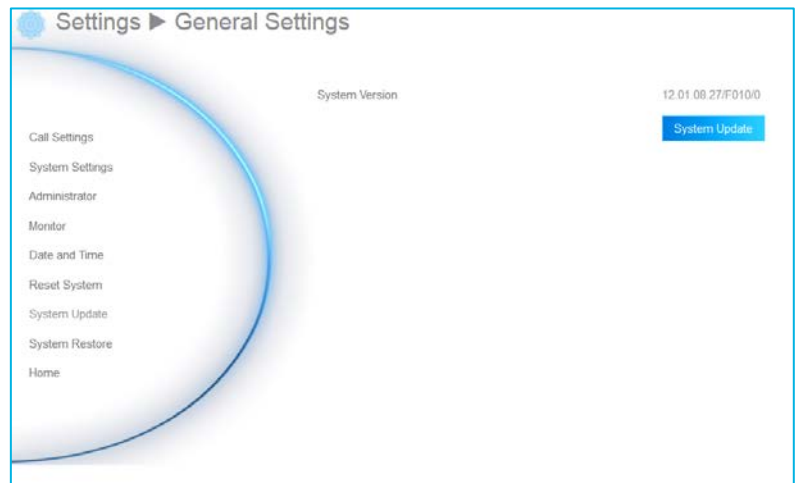

4. Click "**Submit**" to begin the system update or Cancel to stop this operation.



**WARNING!** Please do not perform any operations during the updating process.



## Making a Call

There are 3 methods to make a video call. Select the site contact in the Phonebook list, dialing the IP address or select a previous call in the Call History list.

## Using the Phonebook

Select Phonebook | Contacts List and press



Select the site contact in the Group-Site list

and press



to make a call.

The call will be connected.

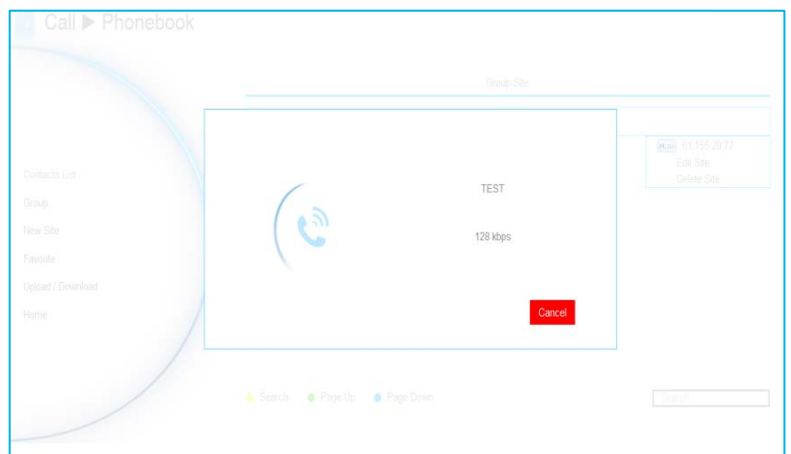
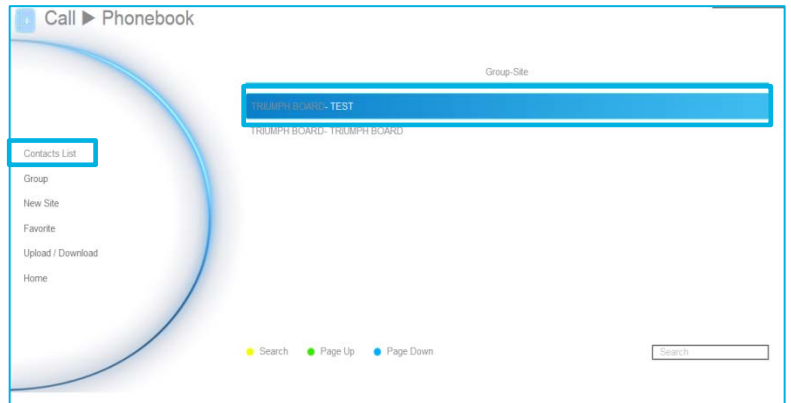

## Using Dial

Select Dial | Dial and press .

Use the remote controller to enter an IP address and select “Call” to make a call.

The call will be connected.

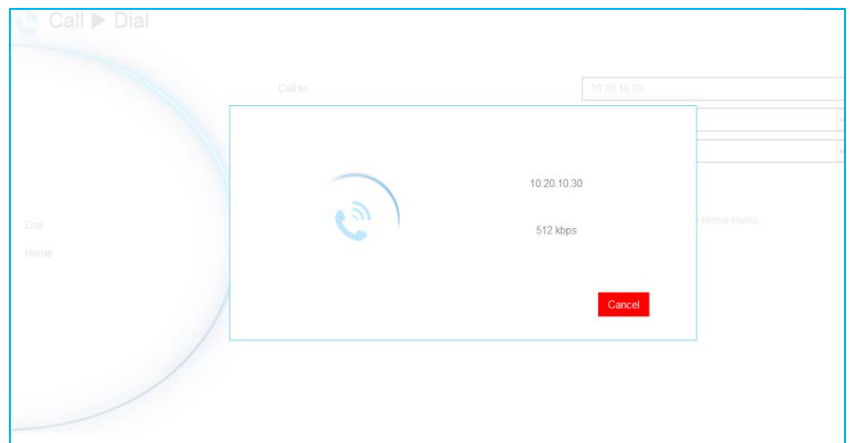
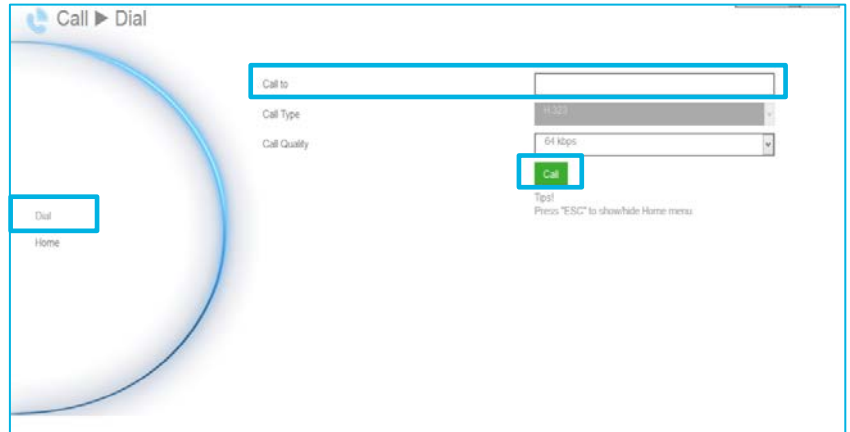

## Using Call History

Select Call History | Call History and press



Select the site you want to call in the call history and press



The call will be connected.



If the call fails, the IP address may have been entered incorrectly, the far site is set to Do not Disturb mode or the far site hung up the call.

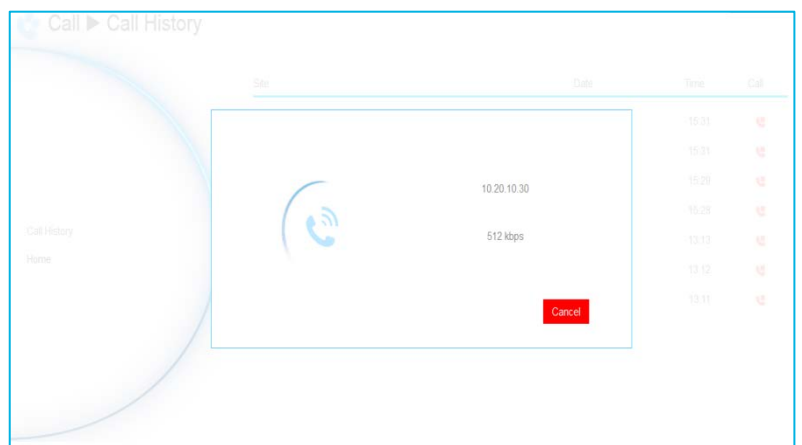

## Scenarios for LAN Connection

### Public IP Configuration (Outside of Firewall)

Your Video Conferencing System VC1 is connecting directly to the internet.





1. From the remote press “Home”-> “>” ->  “Setting”.



2. Press “v” ->  “Network”.



3. Press “LAN Configuration”.
4. And In the drop-down list “IP Address Type”, choose “Static IP”.
5. Manually input the “IP address”, “Subnet Mask” and “Default Gateway”.
6. Select “Apply” and press  (Enter).
7. Press “Home” on the remote to return to the home menu.
8. Press the  (Call) button on the remote and you are ready to make your first call.

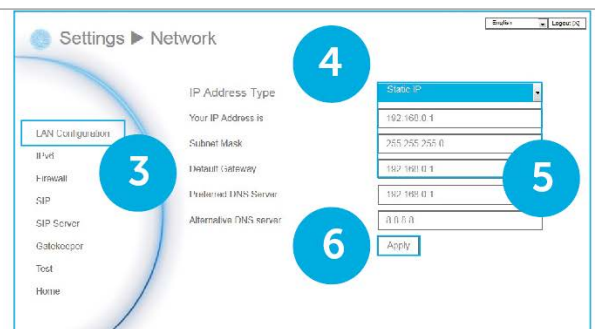



# Private IP Configuration (Behind Firewall with Port Forwarding)

Please make sure you have set the following ports in port forwarding in your firewall.

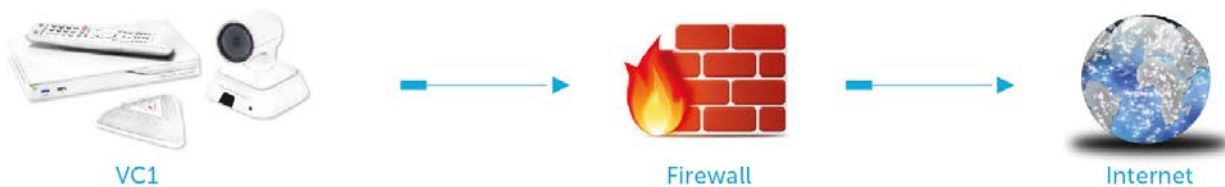

Port	Function	Type
1719	Gatekeeper	UDP
1720	H.323 Call setup	TCP
30000~30019	Signalling and control for audio, call, video and data/FECC	TCP and UDP
80	HTTP Interface (WebTool)	TCP
24	Telnet	TCP
5060	SIP	TCP and UDP

Your Video Conferencing System VC1 is connecting to the internet through a firewall.







1. From the remote press “Home”-> “>” ->  “Setting”.



2. Press “” ->  “Network”.



3. Press “LAN Configuration”.
4. And In the drop-down list “IP Address Type”, choose “Static IP”.
5. Manually input the “IP address”, “Subnet Mask” and “Default Gateway”.
6. Select “Apply” and press  (Enter).
7. Press  (Back) on the remote to return to previous menu. (If you have H.323 ALG enabled, skip to step 10).
8. In the same page, go to “Firewall” and press  (Enter).
9. Select “ON” in the NAT check box and enter the IP address in the “NAT Public (WAN) address” field.
10. Press the “Home” button on the remote to return the home menu.
11. Press the  Call button on the remote and you are ready to make your first call.

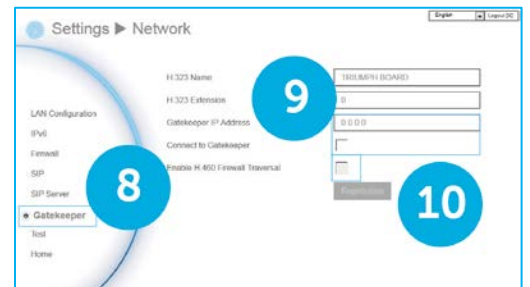
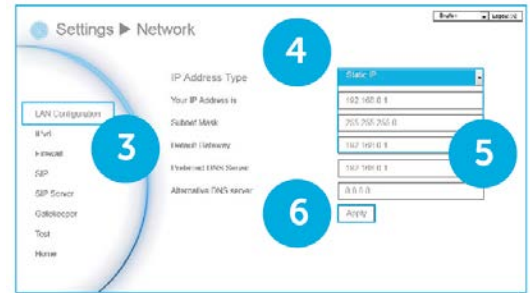





## H.460 Gatekeeper with Firewall Traversal

Your Video Conferencing System VC1 is connecting to the internet through a firewall and you have a Gatekeeper outside the firewall.





1. From the remote press “Home”-> “>” ->  “Setting”.





2. Press “” ->  “Network”.

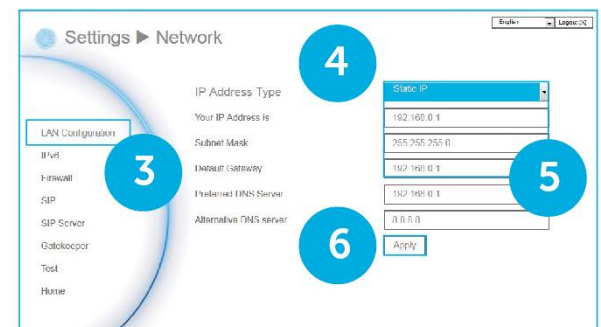

3. Press “LAN Configuration (IPv4)”.
4. And In the drop-down list “IP address Type”, choose “Static IP”.
5. Manually input the “IP address”, “Subnet Mask” and “Default Gateway”.
6. Select “Apply” and press  (Enter).
7. In the same page, go to “Gatekeeper” and press  (Enter).



8. Go to “Gatekeeper” and press  (Enter).
9. Enter the IP address of your Gatekeeper in the “Gatekeeper IP Address” field and enable the “Connect to Gatekeeper” check box.
10. Enable the “Enable H.460 firewall Traversal” option.
11. Press the “Home” button on the remote to return the home menu.
12. Press the  (Call) button on the remote and you are ready to make your first call.

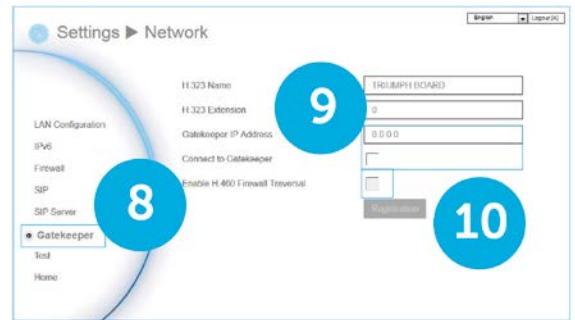

## Specifications

Hardware	
I/O Ports	Camera In Port *1
	VGA Out Port *1
	VGA In Port *1
	Audio Out Port *1
	Audio In Port *1
	MIC In Port *1
	HDMI Out Port *1
	USB 2.0 Port *2 (Front and Back Panel)
LAN Connector	RJ-45
Camera (HD fixed focus Camera)	2-megapixel CMOS camera
	Pan/tilt with 4x digital zoom
	88° FOV
Remote Controller	IR
Power	AC 100V ~ 240V, 50/60Hz
	Consumption: EIAJ 12V, 4A
Housing	White Aluminum
Dimensions (L x W x H)	Main System (codec): 260 x 158.7 x 33 mm
	Camera: 122.6 x 122.6 x 127.8 mm
	Video Conferencing System VC1 Microphone Array: 131.9 x 118.6 x 25.5 mm
	Package: 330 x 230 x 265 mm
Package Weight	3.7kg (8.15lbs)
Video	
Video Inputs	HD camera / VGA
Video Outputs	HDMI / VGA
Resolutions (People)	HD1080p (1920 x 1080)
	HD720p (1280 x 720)
	480p (848 x 480)
	4SIF (704) x 480), 4CIF (704 x 576)
	WCIF (512 x 288)
	SIF (352 x 240), CIF (352 x 288)
All resolutions at 30fps	

Video	
Resolutions (Content)	Support:
	WSXGA (1440 x 900)
	HD (1360 x 768)
	SXGA (1280 x 800)
	WXGA (1280 x 800)
	HD720p (1280 x 720)
	XGA (1024 x 768)
	SVGA (800 x 600)
	VGA (640 x 480)
	Output:
	HD720p (1280 x 720) up to 30fps
Audio	
Audio Inputs	VC1 microphone array
	Line-in (3.5 mm)
Audio Outputs	Digital audio on HDMI cable
	Line-out (3.5 mm)
Supported Standards	
Video	H.264, H.263, H.263+, H.261
	H.239 dual video streams
Audio	G.711, G.722, G.722.1*, G.722.1C*, G.728,
Others	H.224 / H.281 / H.225 / H.245 / H.323 Annex Q
Control Information	
Program Control	Web Server / User Interface
Remote Control	Remote Controller
Ethernet Protocol	HTTP, DHCP, TCP/IP, ICMP (ping)
Web Server	LAN, RJ-45 (10/100/1000)
Environment	
Operation	Temperature: 0 ~ 40°C
	Humidity: 20% ~ 80%
Storage	Temperature: -20 ~ 60°C
	Humidity: 20% ~ 80%
Warranty	
2 Years according to the manufacturer's warranty conditions.	

\*: G.722.1/G.722.1C, licensed from Polycom®

## Troubleshooting

### Audio

1. Can't hear the audio during a call
  - Make sure the MICs are not muted.
  - Make sure the MIC connections are properly connected as illustrated in the manual.
  - Ensure proper volume level on the system.
2. The audio quality is poor
  - Ensure the MIC is not damaged.
  - Try to adjust the "Mic Gain Level".
  - Make sure the MIC is not facing the output speakers to prevent echo.



### Video/Display

1. Video conference call is established but no video or voice.
  - If you are connecting to TRIUMPH BOARD Video Conferencing System VC1 with firewall, make sure you have done the port forwarding correctly. For non H.323 ALG firewall, please set the NAT configuration and the WAN IP address on TRIUMPH BOARD Video Conferencing System VC1 is entered.
  - We suggest having a fixed public IP address for TRIUMPH BOARD Video Conferencing System VC1. With Dynamic public IP address, it will change after a certain period which depends on your local ISP.
  - There is a routing issue if you installed two TRIUMPH BOARD Video Conferencing Systems VC1 sharing one public IP address.
2. Unable to connect to other Video Conferencing systems.
  - Check to see if you dial the correct IP address.
  - Ensure the power status of the device from the other site is on.
  - Verify if the firewall blocks the inbound traffics from the other site.
  - Verify if the other site rejected your Video Conferencing call.
3. Unable to see the OSD.
  - Check to see if your cable is connecting correctly.
  - Make sure your system and display are well-connected and then reboot your system. (Your display should be switched on before you reboot your system.)
4. Why the content sharing is not 720p when the source is 720p?
  - TRIUMPH BOARD Video Conferencing Systems VC1 systems support up to 720p content sharing and default value is XGA. For a 16:9(720P) video display, you have to configure it by manually.
5. Why can't I see the UI configuration screen after connecting the VGA cable and powering on TRIUMPH BOARD Video Conferencing System VC1 upon screen saver mode?
  - Please plug and unplug the VGA connector again to re-connection the VGA cable.

## Network

1. The LAN connection is fail.
  - Make sure you have changed your default IP address. The default IP address is 192. 168.0.1, in order not to conflict with other devices in the same LAN, please change your IP address at the start.
2. Cannot open WebTool by IE9 and IE10.
3. Click  (General Setting icon) in IE.
4. Select “F12 developer tools”.
5. Change Document Mode to Internet Explorer 9 standards.1
6. Disable intranet sites in Compatibility View. Go to “Tools | Compatibility view settings”.
7. Unclick the checkbox “Display intranet sites in Compatibility View” and then click “Close”.

## Others

1. Unable to connect the call and the “Call failed” error message appears on the screen.
  - Ensure the IP address for the calling is correctly.
  - Ensure the other end of your calling does not set their system to “Do Not Disturb” mode or pick up the phone.
  - Ensure you are not calling to a system that has already up to maximum call-in limitation.
  
2. Forget the administrator password.
  - Please contact TRIUMPH BOARD technical support for assistance.
  
3. Unable to control the far end camera.
  - Make sure the “Cam Ctrl”  icon is positioned on the screen you want to control. Press “Far/Near”  button on the remote controller to switch to the desired screen.
  - Make sure the far site has enabled the “Far Control of Near Camera” setting. To enable this function, press “Home”  button and got to Setting | System setting and then select “Far control of Near Camera”.
  
4. TRIUMPH BOARD Video Conferencing System VC1 cannot detect the USB device.
  - Unplug and plug the USB flash drive again and wait for 10 to 15 seconds for the system to re-detect the new USB device.
  - We do not recommend using an external HDD; it may cause system errors or recording failures.
  
5. Cannot see user interface while connecting with VGA.
  - Hold down the “Dual” key in the remote control for a while.

## Remote Control Battery Safety Information

1. Store batteries in any cool & dry place.
2. Do not dispose used batteries in domestic waste. Dispose batteries at special collection points or return to stores if applies.
3. Remove the batteries if they are not in use for long period of time. Battery leakage and corrosion can damage the remote control, dispose batteries safely.
4. Do not mix and use old and new batteries.
5. Do not mix and use different types of batteries: alkaline, standard (carbon-zinc) or rechargeable (nickel-cadmium).
6. Do not dispose batteries in a fire.
7. Do not attempt to short circuit the battery terminals.

## Limited Warranty

For a period of time beginning on the date of purchase of the applicable product and extending as set forth in the **“Warranty Period of TRIUMPH BOARD Product Purchased”** section of the warranty card, TRIUMPH BOARD a.s. (“TRIUMPH BOARD”) warrants that the applicable product (“Product”) substantially conforms to TRIUMPH BOARD’s documentation for the product and that its manufacture and components are free of defects in material and workmanship under normal use. “You” as used in this agreement means you individually or the business entity on whose behalf you use or install the product, as applicable. This limited warranty extends only to you as the original purchaser. Except for the foregoing, the Product is provided “AS IS.” In no event does TRIUMPH BOARD warrant that You will be able to operate the Product without problems or interruptions, or that the Product is suitable you’re your purposes. Your exclusive remedy and the entire liability of TRIUMPH BOARD under this paragraph shall be, at TRIUMPH BOARD’s option, the repair or replacement of the Product with the same or a comparable product. This warranty does not apply to (a) any Product on which the serial number has been defaced, modified, or removed, or (b) cartons, cases, batteries, cabinets, tapes, or accessories used with this product. This warranty does not apply to any Product that has suffered damage, deterioration or malfunction due to (a) accident, abuse, misuse, neglect, fire, water, lightning, or other acts of nature, commercial or industrial use, unauthorized product modification or failure to follow instructions included with the Product, (b) misapplication of service by someone other than the manufacturer’s representative, (c) any shipment damages (such claims must be made with the carrier), or (d) any other causes that do not relate to a Product defect. The Warranty Period of any repaired or replaced Product shall be the longer of (a) the original Warranty Period or (b) thirty (30) days from the date of delivery of the repaired or replaced product.

## Limitations of Warranty

TRIUMPH BOARD makes no warranties to any third party. You are responsible for all claims, damages, settlements, expenses, and attorneys’ fees with respect to claims made against you as a result of your use or misuse of the Product. This warranty applies only if the Product is installed, operated, maintained, and used in accordance with TRIUMPH BOARD specifications. Specifically, the warranties do not extend to any failure caused by (i) accident, unusual physical, electrical, or electromagnetic stress, neglect or misuse, (ii) fluctuations in electrical power beyond TRIUMPH BOARD specifications, (iii) use of the Product with any accessories or options not furnished by TRIUMPH BOARD or its authorized agents, or (iv) installation, alteration, or repair of the Product by anyone other than TRIUMPH BOARD or its authorized agents.

## Disclaimer of Warranty

EXCEPT AS EXPRESSLY PROVIDED OTHERWISE HEREIN AND TO THE MAXIMUM EXTENT PERMITTED BY APPLICABLE LAW, TRIUMPH BOARD DISCLAIMS ALL OTHER WARRANTIES WITH RESPECT TO THE PRODUCT, WHETHER EXPRESS, IMPLIED, STATUTORY OR OTHERWISE, INCLUDING WITHOUT LIMITATION, SATISFACTORY QUALITY, COURSE OF DEALING, TRADE USA OR PRACTICE OR THE IMPLIED WARRANTIES OF MERCHANTABILITY, FITNESS FOR A PARTICULAR PURPOSE OR NONINFRINGEMENT OF THIRD PARTY RIGHTS.



## Limitation of Liability

IN NO EVENT SHALL TRIUMPH BOARD BE LIABLE FOR INDIRECT, INCIDENTAL, SPECIAL, EXEMPLARY, PUNITIVE, OR CONSEQUENTIAL DAMAGES OF ANY NATURE INCLUDING, BUT NOT LIMITED TO, LOSS OF PROFITS, DATA, REVENUE, PRODUCTION, OR USE, BUSINESS INTERRUPTION, OR PROCUREMENT OF SUBSTITUTE GOODS OR SERVICES ARISING OUT OF OR IN CONNECTION WITH THIS LIMITED WARRANTY, OR THE USE OR PERFORMANCE OF ANY PRODUCT, WHETHER BASED ON CONTRACT OR TORT, INCLUDING NEGLIGENCE, OR ANY OTHER LEGAL THEORY, EVEN IF TRIUMPH BOARD HAS ADVISED OF THE POSSIBILITY OF SUCH DAMAGES. TRIUMPH BOARD'S TOTAL, AGGREGATE LIABILITY FOR DAMAGES OF ANY NATURE, REGARDLESS OF FORM OF ACTION, SHALL IN NO EVENT EXCEED THE AMOUNT PAID BY YOU TO TRIUMPH BOARD FOR THE SPECIFIC PRODUCT UPON WHICH LIABILITY IS BASED.

## Governing Law and Your Rights

This warranty gives you specific legal rights; you may also have other rights granted under state law. These rights vary from state to state.

## Federal Communications Commission Statement (Class A)

**FC** NOTE- This equipment has been tested and found to comply with the limits for a Class A digital device, pursuant to Part 15 of the FCC Rules. These limits are designed to provide reasonable protection against harmful interference in a residential installation. This equipment generates uses and can radiate radio frequency energy and, if not installed and used in accordance with the instructions, may cause harmful interference to radio communications. However, there is no guarantee that interference will not occur in a particular installation. If this equipment does cause harmful interference to radio or television reception, which can be determined by tuning the equipment off and on, the user is encouraged to try to correct the interference by one or more of the following measures:

Reorient or relocate the receiving antenna.

Increase the separation between the equipment and receiver.

Connect the equipment into an outlet on a circuit different from that to which the receiver is connected.

Consult the dealer or an experienced radio/television technician for help.

☞ For warranty period, please refer to the warranty card.

## Class A ITE

Class A ITE is a category of all other ITE which satisfies the class A ITE limits but not the class B ITE limits. Such equipment should not be restricted in its sale but the following warning shall be included in the instructions for use:

**Warning** - This is a class A product. In a domestic environment this product may cause radio interference in which case the user may be required to take adequate measures.

## CE Class A (EMC)



This product is herewith confirmed to comply with the requirements set out in the Council Directives on the Approximation of the laws of the Member States relating to Electromagnetic Compatibility Directive 2004/108/EC.

**Warning** - This is a Class A product. In a domestic environment this product may cause radio interference in which case the user may be required to take adequate measures to correct this interference.

## Copyright

© 2014 by TRIUMPH BOARD a.s. All rights reserved. No part of this publication may be reproduced, transmitted, transcribed, stored in a retrieval system, or translated into any language in any form by any means without the written permission of TRIUMPH BOARD a.s.



The mark of Crossed-out wheeled bin indicates that this product must not be disposed of with your other household waste. Instead, you need to dispose of the waste equipment by handing it over to a designated collection point for the recycling of waste electrical and electronic equipment. For more information about where to drop off your waste equipment for recycling, please contact your household waste disposal service or the shop where you purchased the product.

## Trademarks

TRIUMPH BOARD is registered trademarks of TRIUMPH BOARD a.s. Other trademarks used herein for description purpose only belong to each of their companies.

## Disclaimer

No warranty or representation, either expressed or implied, is made with respect to the contents of this documentation, its quality, performance, merchantability, or fitness for a particular purpose. Information presented in this documentation has been carefully checked for reliability; however, no responsibility is assumed for inaccuracies. The information contained in this documentation is subject to change without notice. In no event will TRIUMPH BOARD be liable for direct, indirect, special, incidental, or consequential damages arising out of the use or inability to use this product or documentation, even if advised of the possibility of such damages.

TRIUMPH BOARD a.s.  
Website: <http://www.triumphboard.com>